

Due to Governor Gavin Newsom's Executive Order and the City Council's Proclamation of Local Emergency, we can no longer offer an in-person meeting location for the community to attend public meetings.

You may watch the meeting live in the following ways:

- Visit the City's website [santa-ana.org/city-meetings](http://santa-ana.org/city-meetings) and select the active link for the current Planning Commission meeting.
- Visit the City's YouTube site at [youtube.com/cityofsantaanavideos/live](https://youtube.com/cityofsantaanavideos/live).

You may provide a comment in the following ways:

- Send an e-mail to [ecomments@santa-ana.org](mailto:ecomments@santa-ana.org) (reference "Planning Commission Public Comment for Agenda Item No. #" in the subject line). Make sure to include your name, whether you are in support of or in opposition to the item and why. The deadline to submit comments is 5:00 p.m. **on the day of the meeting**. Comments received by the deadline will be distributed to the Commission prior to the start of the meeting and will also be posted on our website at [www.santa-ana.org/cc/city-meetings](http://www.santa-ana.org/cc/city-meetings). Comments received after the deadline may not be distributed to the Commission but will be posted on the City's website at the earliest possible opportunity after the meeting; or
- Join the Zoom Webinar directly at: <https://us02web.zoom.us/j/315965149>; or
- Call 669-900-9128 and enter Meeting ID: 315 965 149# when prompted. Callers can begin joining the speaker que by 5:00 p.m. on the day of the meeting. While the item that you would like to comment on is being discussed, dial \*9 to let us know that you want to speak. After the clerk confirms the last three digits of caller's phone number and unmutes them, the caller must press \*6 to speak. You will have 3 minutes to state your name, whether you are in support of or in opposition to the item, and why. *If you are calling in and watching YouTube, please turn your volume down on YouTube to limit any feedback when you speak.*

## CITY OF SANTA ANA PLANNING COMMISSION REGULAR MEETING AGENDA

OCTOBER 26, 2020  
5:30 P.M.

VIRTUAL MEETING

**MARK McLOUGHLIN**  
*Chair, Citywide Representative*

**CYNTHIA CONTRERAS-LEO**  
*Vice Chair, Ward 5 Representative*

**FELIX RIVERA**  
*Ward 2 Representative*

**V. THAI PHAN**  
*Ward 4 Representative*



**Minh Thai**  
*Executive Director*

**Lisa E. Storck**  
*Legal Counsel*

**Vince Fregoso, AICP**  
*Planning Manager*

**Sarah Bernal**  
*Recording Secretary*

**NORMA GARCIA**  
*Ward 1 Representative*

**KENNETH NGUYEN**  
*Ward 3 Representative*

**THOMAS MORRISSEY**  
*Ward 6 Representative*

**Si tiene preguntas en español, favor de llamar a Narcee Perez al (714) 667-2260.  
Nếu cần liên lạc bằng tiếng Việt, xin điện thoại cho Tony Lai số (714) 565-2627.**

**Translation Services:** If you require translation services to participate in this meeting, please contact Sarah Bernal at [sbernal@santa-ana.org](mailto:sbernal@santa-ana.org) no later than 48 hours prior to the scheduled meeting.

**Special Assistance:** If you need special assistance to participate in this meeting, please contact Michael Ortiz, ADA Program Coordinator, at (714) 647-5624. Please call prior to the meeting date, to allow the City time to make reasonable arrangements for accessibility to this meeting [Americans with Disabilities Act, Title II, 28 CFR 35.102].

## Basic Planning Commission Meeting Information

The Planning Commission Agenda can be found online at

<https://www.santa-ana.org/cc/city-meetings>

**Planning Commission:** The Santa Ana Planning Commission consists of seven residents of the city who are appointed by Santa Ana City Councilmembers. The Commission meets regularly on the second and fourth Monday of each month. Meetings begin at 5:30 p.m., unless otherwise noted.

The Planning Commission is responsible for providing input to the City Council on long-range planning. Santa Ana's long-range planning goals are embodied in the General Plan. The General Plan and the amendments to it are reviewed by the Planning Commission and adopted by the City Council. The General Plan is implemented through the City's development regulations.

The Planning Commission has the authority to approve or deny applications concerning development within the City. The category of applications includes Conditional Use Permits, Variances, Tentative Tract and Parcel Maps, Minor Exceptions, Site Plan Review, and Public Convenience or Necessity Determinations. The Planning Commission also makes recommendations to the City Council on all Zoning and General Plan amendments, Development Agreements, Specific Developments, and Specific Plans.

**Agenda and Staff Reports:** An agenda along with staff reports are provided for each Planning Commission meeting. The Planning Commission agenda and staff reports is posted at least 72 hours prior to the meeting on the City's website at [www.santa-ana.org/cc/city-meetings](http://www.santa-ana.org/cc/city-meetings), and on the posting boards outside the Civic Center entrance, Council Chamber, and Library. If you have any questions regarding any item of business on the agenda for this meeting, or any of the staff reports or other documentation relating to any agenda item, please contact the Planning and Building Agency at 714-667-2732.

The items on the agenda are arranged in four categories:

1. **Consent Calendar:** These are relatively minor in nature, do not have any outstanding issues or concerns, and do not require a public hearing. All consent calendar items are considered by the Commission as one item and a single vote is taken for their approval, unless an item is pulled from the consent calendar for individual discussion. There is typically no Commission discussion of consent calendar items unless requested.
2. **Business Items:** Items in this category are general in nature and may require Commission action. Public input may be received at the request of the Commission.
3. **Public Hearings:** This category is for case applications that require, by law, a hearing open to public comment because of the discretionary nature of the request. Public hearings are formally conducted and public input/testimony is requested at a specific time. This is your opportunity to speak on the item(s) that concern you.
4. **Work Study Session:** Items in this category are generally items requiring discussion. No action will be taken.

**Public Hearing Procedure:** The Planning Commission will follow the following procedure for all items listed as public hearing items:

1. The Chair will ask for presentation of the staff report;
2. The Commission will have the opportunity to question staff in order to clarify any specific points;
3. The public hearing will be opened;
4. The applicant/ project representative will be allowed to make a presentation, for a maximum of 15 minutes.
5. Members of the audience will be allowed to speak, for a maximum of 3 minutes per speaker.
6. The applicant will be given an opportunity to respond to comments made by the audience;
7. The public hearing will be closed; and
8. Discussion of the proposal will return to the Commission with formal action taken to approve, conditionally approve, deny, or continue review of the application.

**Appeals:** The formal action by the Planning Commission regarding Conditional Use Permits, Variances, Tentative Tract and Parcel Maps, Minor Exceptions, Site Plan Review, and Public Convenience or Necessity Determinations are final and shall become effective after the ten-day appeal period (unless the City Council in compliance with section 41-643, 41-644 or 41-645 holds a public hearing on the matter, then the formal action will become effective on the day following the hearing and decision by the City Council). An appeal from the decision or requirement of the Planning Commission may be made by any interested party, individual, or group. The appeal must be filed with the Clerk of the Council, accompanied by the required filing fee, and a copy sent to the Planning Department, within ten days of the date of the Commission's action, by 5:00 p.m. If the final day to appeal falls on a City Hall observed holiday or a day when City hall is closed, the final day to appeal shall be extended to the next day City Hall is

open for public business. Please note: Under California Government Code Sec. 65009, if you challenge in court any of the matters on this agenda for which a public hearing is to be conducted, you may be limited to raising only those issues which you (or someone else) raised orally at the public hearing or in written correspondence received by the Planning Commission or City Council at or before the hearing.

### Submittal of information for dissemination or presentation

**Written Materials/Handouts:** Any member of the public who desires to submit documentation in hard copy form may do so prior to the meeting or at the time he/she addresses the Planning Commission. Please provide 15 copies of the information to be submitted and file with the Recording Secretary at the time of arrival to the meeting. This information will be disseminated to the Planning Commission at the time testimony is given.

**Large Displays/Maps/Renderings:** Any member of the public who desires to display freestanding large displays or renderings in conjunction with their public testimony is asked to notify the Planning and Building Agency at 714-667-2732 no later than noon on the day of the scheduled meeting.

**Electronic Documents/Audio-Visuals:** Any member of the public who desires to display information electronically in conjunction with their public testimony is asked to submit the information to the Planning and Building Agency at 714-667-2732 no later than noon on the day of the scheduled meeting.

**Code of Ethics and Conduct:** The people of the City of Santa Ana, at an election held on February 5, 2008, approved an amendment to the City Charter which established the Code of Ethics and Conduct for elected officials and members of appointed boards, commissions, and committees to assure public confidence. A copy of the City's Code can be found on the Clerk of the Council's webpage. The following are the core values expressed: Integrity · Honesty · Responsibility · Fairness · Accountability · Respect · Efficiency

**Senate Bill 343:** As required by Senate Bill 343, any non-confidential writings or documents provided to a majority of the Planning Commission members regarding any item on this agenda will be made available for public inspection in the Planning & Building Agency during normal business hours.

**CITY OF SANTA ANA  
PLANNING COMMISSION  
MEETING AGENDA**

**CALL TO ORDER**

**ROLL CALL**

**PLEDGE OF ALLEGIANCE**

**PUBLIC COMMENTS (non-agenda items):** Individuals may comment on an agenda item in the following ways: (1) You may submit written comments by email to [ecomments@santa-ana.org](mailto:ecomments@santa-ana.org) (reference "Planning Commission Public Comment for Agenda Item #" in the subject line). The deadline to submit comments is 5:00 p.m. **on the day of the meeting**; or (2) You may join the Zoom Webinar directly at: <https://us02web.zoom.us/j/315965149>; or (3) You may comment by phone while the meeting is in progress by calling 669-900-9128. Enter Meeting ID: 315 965 149# when prompted. While the item that you would like to comment on is being discussed, dial \*9 to let us know that you want to speak. After you are called upon, you must press \*6 to unmute yourself. Please state your name, whether you are in support or opposition to an item and why. You will have 3 minutes to speak.

**CONSENT CALENDAR**

Individuals may comment on an agenda item in the following ways: (1) You may submit written comments by email to [ecomments@santa-ana.org](mailto:ecomments@santa-ana.org) (reference "Planning Commission Public Comment for Agenda Item #" in the subject line). The deadline to submit comments is 5:00 p.m. **on the day of the meeting**; or (2) You may join the Zoom Webinar directly at: <https://us02web.zoom.us/j/315965149>; or (3) You may comment by phone while the meeting is in progress by calling 669-900-9128. Enter Meeting ID: 315 965 149# when prompted. While the item that you would like to comment on is being discussed, dial \*9 to let us know that you want to speak. After you are called upon, you must press \*6 to unmute yourself. Please state your name, whether you are in support or opposition to an item and why. You will have 3 minutes to speak.

**RECOMMENDED ACTION:**      **Approve staff recommendation on the following Consent Calendar Item: A – B.**

A. MINUTES FROM THE OCTOBER 12, 2020 REGULAR MEETING.

**RECOMMENDED ACTION:**      ***Approve the minutes.***

B. EXCUSED ABSENCES

**RECOMMENDED ACTION:**      ***Excuse absent commission members.***

**\* \* \* END OF CONSENT CALENDAR \* \* \***

## **BUSINESS CALENDAR**

Individuals may comment on an agenda item in the following ways: (1) You may submit written comments by email to [ecomments@santa-ana.org](mailto:ecomments@santa-ana.org) (reference "Planning Commission Public Comment for Agenda Item #" in the subject line). The deadline to submit comments is 5:00 p.m. **on the day of the meeting;** or (2) You may join the Zoom Webinar directly at: <https://us02web.zoom.us/j/315965149>; or (3) You may comment by phone while the meeting is in progress by calling 669-900-9128. Enter Meeting ID: 315 965 149# when prompted. While the item that you would like to comment on is being discussed, dial \*9 to let us know that you want to speak. After you are called upon, you must press \*6 to unmute yourself. Please state your name, whether you are in support or opposition to an item and why. You will have 3 minutes to speak.

## **PUBLIC HEARING**

**APPEAL OF PLANNING COMMISSION ACTIONS:** The Planning Commission decision on Conditional Use Permits, Variances, Tentative Tract and Parcel Maps, Minor Exceptions, Site Plan Review, and Public Convenience or Necessity Determinations are final unless appealed within 10 days of the decision by any interested party or group (refer to the Basic Meeting Information page for more information). The Planning Commission recommendation on Zoning and General Plan amendments, Development Agreements, Specific Developments, and Specific Plans will be forwarded to the City Council for final determination. **NOTICE:** Legal notice was published in the Orange County Reporter and notices were mailed on October 14, 2020.

### **1. SITE PLAN REVIEW NO. 2020-04 – Selena Kelaher, Case Planner.**

**LOCATION:** 1801 East Fourth Street located in the Metro East Mixed-Use Overlay Zone (MEMU), Active Urban (AU) zoning district

**REQUEST:** The applicant is requesting approval of a site plan review to facilitate construction of Central Pointe, a mixed-use development project consisting of two buildings with a total of 644 residential units, 15,130 square feet of commercial space, 1,318 parking spaces and associated amenities and open space.

**ENVIRONMENTAL DETERMINATION:** In accordance with the California Environmental Quality Act (CEQA), the project has been determined to be adequately evaluated in the previously certified Environmental Impact Report (EIR) No. 2006-01 (SCH No. 2006031041) and Subsequent EIR SEIR No. 2018-15 as per Sections 15162 and 15168 of the CEQA guidelines. All mitigation measures in EIR No. 2006-01 and SEIR No. 2018-15 and associated Mitigation Monitoring and Reporting Program (MMRP) will be enforced and apply to the proposed project.

**RECOMMENDED ACTION: Adopt a Resolution.** A RESOLUTION OF THE PLANNING COMMISSION OF THE CITY OF SANTA ANA APPROVING SITE PLAN REVIEW NO. 2020-04 AS CONDITIONED FOR A NEW MIXED-USE RESIDENTIAL AND COMMERCIAL DEVELOPMENT FOR THE PROPERTY LOCATED AT 1801 EAST FOURTH STREET

### **2. ENVIRONMENTAL REVIEW NO. 2018-83, GENERAL PLAN AMENDMENT NO. 2020-04, AMENDMENT APPLICATION NO. 2020-02, AND TENTATIVE TRACT MAP NO. 2019-02 – Jerry Guevara, Case Planner.**

**LOCATION:** 301 and 305 North Mountain View Street located in the General Agricultural (A1) zoning district.

**REQUEST:** The applicant proposes to construct a new eight-unit condominium development. In order to facilitate the construction of this project, the applicant is requesting approval of the

following land use entitlements: (1) a general plan amendment to change the site's current land use designation from Low-Medium Density Residential (LMR-11) to Medium Density Residential (MR-15), (2) an amendment application to change the zoning designation of the property from General Agricultural (A1) to Two-Family Residence (R2), and (3) a tentative tract map to allow subdivision of the property for condominium purposes. In addition, the applicant is requesting adoption of a Mitigated Negative Declaration and Mitigation Monitoring and Reporting Program. In conjunction with this project, the City is also proposing to change the General Plan Land Use designation and zoning of adjacent properties on the block stretching from First Street to Fifth Street to ensure consistency between zoning and the General Plan.

**ENVIRONMENTAL DETERMINATION:** In accordance with the California Quality Environmental Act (CEQA), a Mitigated Negative Declaration (MND), Environmental Review No. 2018-83, with technical studies, was prepared for the project. No areas of significance or unavoidable impacts were determined to occur from the construction or operation of the proposed project. The project requires adoption of a Mitigation Monitoring and Reporting Program (MMRP), which contains mitigation measures to address biological resources, geology and soils, noise, hydrology and water quality, tribal cultural resources and cultural resources.

**RECOMMENDED ACTIONS:**

- a) **Adopt a Resolution.** A RESOLUTION OF THE PLANNING COMMISSION OF THE CITY OF SANTA ANA ADOPTING A MITIGATED NEGATIVE DECLARATION AND MITIGATION MONITORING AND REPORTING PROGRAM, ENVIRONMENTAL REVIEW NO. 2018-83, RELATIVE TO TENTATIVE TRACT MAP NO. 2019-02 FOR THE PROJECT LOCATED AT 301 AND 305 NORTH MOUNTAIN VIEW STREET
- b) **Adopt a Resolution:** A RESOLUTION OF THE PLANNING COMMISSION OF THE CITY OF SANTA ANA APPROVING TENTATIVE TRACT MAP NO. 2019-02 AS CONDITIONED TO CREATE A SUBDIVISION OF EIGHT (8) CONDOMINIUM UNITS AT 301 AND 305 NORTH MOUNTAIN VIEW STREET
- c) **Recommend that the City Council adopt a Resolution:** A RESOLUTION OF CITY COUNCIL OF THE CITY OF SANTA ANA ADOPTING A MITIGATED NEGATIVE DECLARATION AND MITIGATION MONITORING AND REPORTING PROGRAM, ENVIRONMENTAL REVIEW NO. 2018-83, RELATIVE TO GENERAL PLAN AMENDMENT NO. 2020-04 AND AMENDMENT APPLICATION NO. 2020-02 FOR THE PROJECT LOCATED AT 301 AND 305 NORTH MOUNTAIN VIEW STREET
- d) **Recommend that the City Council adopt a Resolution:** A RESOLUTION OF THE CITY COUNCIL OF THE CITY OF SANTA ANA APPROVING GENERAL PLAN AMENDMENT NO. 2020-04 TO CHANGE THE GENERAL PLAN LAND USE DESIGNATIONS FOR THE PROPERTIES LOCATED AT 4310, 4314, 4318, 4322, 4326 AND 4330 WEST FIFTH STREET; 113, 117, 121, 201, 203, 207, 211, 221, 223, 225, 227, 229, 231, 233, 235, 237, 239, 241, 243, 245, 247, 301, 305, 321, 323, 325, 327, 329, 331, 333, 335, 337, 339, 341, 343, 345, 347, 349, 351, 353, 355, 357, 359, 361, 363, 365, 409 AND 411 NORTH MOUNTAIN VIEW STREET; AND 4311, 4315, 4317, 4319, 4321, 4323, 4325, 4327, 4329, 4331, 4333, 4335, 4337 AND 4339 WEST FIRST STREET

- e) **Recommend that the City Council adopt an Ordinance:** AN ORDINANCE OF THE CITY COUNCIL OF THE CITY OF SANTA ANA APPROVING AMENDMENT APPLICATION NO. 2020-02 REZONING THE PROPERTIES LOCATED AT 4310, 4314, 4318, 4322, 4326 AND 4330 WEST FIFTH STREET; 113, 117, 121, 201, 203, 207, 211, 221, 223, 225, 227, 229, 231, 233, 235, 237, 239, 241, 243, 245, 247, 301, AND 305 NORTH MOUNTAIN VIEW STREET; AND 4311 WEST FIRST STREET

**\*\*\*END OF BUSINESS CALENDAR\*\*\***

**COMMENTS**

3. STAFF COMMENTS
  
4. COMMISSION MEMBER COMMENTS

**ADJOURNMENT** – A Special Meeting will be held via teleconference on Thursday, November 5 to consider the General Plan Update. The next regular meeting will be held via teleconference on Monday, November 9 at 5:30 p.m.

**ACTION MINUTES OF THE REGULAR MEETING  
OF THE SANTA ANA PLANNING COMMISSION**

**OCTOBER 12, 2020**

**CALLED TO ORDER**

*VIRTUAL MEETING*  
CITY HALL, ROSS ANNEX  
20 CIVIC CENTER PLAZA, ROOM 1600  
SANTA ANA, CALIFORNIA  
5:32 P.M.

**ATTENDANCE**

COMMISSIONERS Present:  
CYNTHIA CONTRERAS-LEO, *Vice Chair*  
NORMA GARCIA (joined at 5:41 p.m.)  
MARK MCLOUGHLIN, *Chair*  
KENNETH NGUYEN  
THOMAS MORRISSEY  
V. THAI PHAN  
FELIX RIVERA

COMMISSIONERS Absent: None.

PLANNING & BUILDING AGENCY STAFF Present:  
MINH THAI, *Executive Director*  
VINCE FREGOSO, *Planning Manager*  
LISA STORCK, *Assistant City Attorney*  
ALI PEZESHKPOUR, *Senior Planner*  
PEDRO GOMEZ, *Associate Planner*  
SELENA KELAHER, *Associate Planner*  
SARAH BERNAL, *Recording Secretary*

**PLEDGE OF ALLEGIANCE**

**PUBLIC COMMENTS (on non-agenda items):** None.

**CONSENT CALENDAR ITEMS**

*\*All votes were taken by roll call*

A. MINUTES FROM THE SEPTEMBER 28, 2020 REGULAR MEETING

**MOTION:** Approve the minutes.

**MOTION:** Nguyen                      **SECOND:** Contreras-Leo

**VOTE:**            **AYES:**            Contreras-Leo, McLoughlin, Nguyen, Phan, Rivera (5)  
                         **NOES:**            None (0)

**ABSTAIN:** Morrissey (1)

**ABSENT:** Garcia (1)

## **BUSINESS CALENDAR**

### **PUBLIC HEARING**

1. ENVIRONMENTAL REVIEW NO. 2018-13, SITE PLAN REVIEW NO. 2020-03, VARIANCE NO. 2020-06 AND AMENDMENT APPLICATION NO. 2020-04 – Pedro Gomez, Case Planner.

Commissioners McLoughlin, Contreras-Leo, Morrissey, Rivera and Phan disclosed that they discussed the project with the applicant.

**LOCATION:** 409 and 509 East Fourth Street located in the Transit Zoning Code (Specific Development No. 84), Downtown subzone and Urban Neighborhood 2 subzone.

**REQUEST:** The applicant is requesting approval of the following land use entitlements: (1) a site plan review to allow a mixed-use development project over four stories in height, (2) a variance to deviate from allowable building size and massing and (3) an amendment application to rezone Site B from Urban Neighborhood 2 (UN-2) subzone to Urban Center (UC) subzone. In addition, the applicant is requesting approval and adoption of an addendum to the Environment Impact Report (EIR) for the Transit Zoning Code Project (SCH NO. 2006071100) and adoption of a mitigation monitoring and reporting program for the Site Plan Review, Variance, and Amendment Application.

Case Planner Gomez provided a staff presentation.

Commission discussion ensued regarding the housing opportunity ordinance, project renderings, outdoor dining options, the transit zoning code map and the addendum to the EIR,

Recording Secretary provided a summary report of written communication received.

Chair McLoughlin opened the public hearing. Representatives of the project spoke in support of the matter; requested Condition No. 6 be modified to amend the timeline for the completion of the art work; answered questions regarding outdoor space, architectural style of the parking garage and affordable housing.

The following individuals spoke on the matter:

- Dave Elliot, spoke in support
- Ryan Chase, spoke in support
- Richard Drury, spoke in opposition.
- Laura (no last name), spoke in opposition
- Andre Robinson, spoke in support.



There were no other speakers and the public hearing was closed.

Vice Chair Contreras-Leo motioned to approve the matter with the following amendment to Condition No. 6: Prior to the issuance of a *certificate of occupancy*, a Public Art Plan must be submitted to the Planning Division for review and approval, and shall include a timeline of the anticipated completion of the art work proposed which shall not be any longer than a year after completion of the project; the motion was seconded by Commissioner Phan. Commissioner Garcia introduced a friendly amendment to allow additional outdoor dining areas, including the sidewalk, with review and approval conducted administratively by staff. Assistant City Attorney Storck informed Commission that an application process is already in place for outdoor dining; no need for added condition. Further discussion ensued regarding screening the parking garage and the Housing Opportunity Ordinance requirements.

**MOTIONS as amended.**

- a) **Adopt Resolution No 2020-33.** A RESOLUTION OF THE PLANNING COMMISSION OF THE CITY OF SANTA ANA APPROVING AND ADOPTING AN ADDENDUM TO THE ENVIRONMENTAL IMPACT REPORT FOR THE TRANSIT ZONING CODE PROJECT (SCH NO. 2006071100) FOR SITE PLAN REVIEW NO. 2020-03 AND VARIANCE NO. 2020-06 AND ADOPTION OF A MITIGATION MONITORING AND REPORTING PROGRAM FOR THE 4TH AND MORTIMER MIXED-USE DEVELOPMENT PROJECT LOCATED AT 409 AND 509 EAST FOURTH STREET;
- b) **Adopt Resolution No 2020-34.** A RESOLUTION OF THE PLANNING COMMISSION OF THE CITY OF SANTA ANA APPROVING SITE PLAN REVIEW NO. 2020-03 AS CONDITIONED FOR A NEW MIXED-USE RESIDENTIAL AND COMMERCIAL DEVELOPMENT FOR THE PROPERTIES LOCATED AT 409 EAST FOURTH STREET (SITE A) AND 509 EAST FOURTH STREET (SITE B);
- c) **Adopt Resolution No 2020-35.** A RESOLUTION OF THE PLANNING COMMISSION OF THE CITY OF SANTA ANA APPROVING VARIANCE NO. 2020-06 AS CONDITIONED TO ALLOW AN INCREASE IN THE ALLOWABLE BUILDING SIZE AND MASSING ON SITE B AS PART OF A NEW MIXED-USE RESIDENTIAL AND COMMERCIAL DEVELOPMENT FOR THE PROPERTIES LOCATED AT 409 EAST FOURTH STREET (SITE A) AND 509 EAST FOURTH STREET (SITE B);
- d) **Recommend that the City Council adopt a Resolution:** A RESOLUTION OF THE CITY COUNCIL OF THE CITY OF SANTA ANA APPROVING AND ADOPTING AN ADDENDUM TO THE ENVIRONMENTAL IMPACT REPORT FOR THE TRANSIT ZONING CODE PROJECT (SCH NO. 2006071100) FOR AMENDMENT APPLICATION NO. 2020-04 AND ADOPTION OF A MITIGATION MONITORING AND REPORTING PROGRAM FOR THE 4TH AND MORTIMER MIXED-USE DEVELOPMENT PROJECT LOCATED AT 409 AND 509 EAST FOURTH STREET; and
- e) **Recommend that the City Council adopt an Ordinance:** AN ORDINANCE OF THE CITY COUNCIL APPROVING AMENDMENT APPLICATION NO. 2020-04 MODIFYING THE SUB-ZONING DESIGNATION OF THE PROPERTIES LOCATED AT 501, 507, 509, 515, AND 519 EAST FOURTH STREET AND THOSE AT 502, 506, 510, 514, 520

EAST FIFTH STREET FROM SPECIFIC DEVELOPMENT NO. 84, URBAN NEIGHBORHOOD 2 (UN-2) SUB-ZONE, TO THE URBAN CENTER (UC) SUB-ZONE

**MOTION:** Contreras-Leo      **SECOND:** Phan

**VOTE:**      **AYES:**      Contreras-Leo, Garcia, McLoughlin, Morrissey, Nguyen, Phan, Rivera (7)

**NOES:**      None (0)

**ABSTAIN:**      None (0)

**ABSENT:**      None(0)

**\*\*\*END OF BUSINESS CALENDAR\*\*\***

**WORK STUDY CALENDAR**

2. REVIEW AND DISCUSS THE PROPOSED PROJECT LOCATED AT 1801 EAST FOURTH STREET.

Commissioner Phan recused herself from discussion due to a conflict of interest; her employer, Ruttan & Tucker, represents the applicant.

Case Planner Kelaher provided a presentation which included information on the following:

- Project Location & Zoning
- Site Photos
- Project Details
- Development Standards
- Site Plan and Conceptual Landscape Plan
- Open Space
- Renderings
- Required Entitlements
- Next Steps

Commission discussion ensued regarding types of units, unit size, affordable housing, open space, landscape, and the parking structure. The applicant spoke in support of the project and answered questions regarding rental rate, interior/exterior materials, retail parking, energy efficiency, and LEED.

**\*\*END OF WORK STUDY CALENDAR\*\*\***

## **COMMENTS**

### 3. STAFF COMMENTS:

Executive Director Thai: Proposed a Special Meeting on November 2 to consider the General Plan Update; commission expressed concern with the proposed date. Staff will reach out to each commissioner to check availability.

### 4. COMMISSION MEMBER COMMENTS:

- Commissioner Morrissey: Would like City Council to adopt design guidelines for the downtown historic district; would like more information on the design review process; would like more time to review the staff reports.
- Commissioner Phan echoed Commissioner Morrissey's comments and encouraged everyone to complete the census survey.
- Chair McLoughlin echoed Commissioner Morrissey's comments; would like the Special Meeting to be held after November 2; thanked the applicants and staff.

**8:15 P.M.** – The next meeting will be on Monday, October 26, 2020 at 5:30 p.m.

Sarah Bernal  
Recording Secretary

# REQUEST FOR Planning Commission Action



**PLANNING COMMISSION MEETING DATE:**

**OCTOBER 26, 2020**

**TITLE:**

**PUBLIC HEARING – SITE PLAN REVIEW NO. 2020-04  
FOR THE CENTRAL POINTE MIXED-USE  
DEVELOPMENT AT 1801 EAST FOURTH STREET**

**PLANNING COMMISSION SECRETARY**

**APPROVED**

- As Recommended
- As Amended
- Set Public Hearing For \_\_\_\_\_

**DENIED**

- Applicant's Request
- Staff Recommendation

CONTINUED TO \_\_\_\_\_

Prepared by Selena Kelaher, AICP

Executive Director

Planning Manager

## RECOMMENDED ACTION

Adopt a resolution approving Site Plan Review No. 2020-04 as conditioned.

### Property Owner and Applicant Information

1. Owner: Park Center Santa Ana Associates, L.P.
2. Applicant: Waterford Property Company
3. Project Representative: Sean Rawson

### Executive Summary

Sean Rawson with Waterford Property Company, representing Park Center Santa Ana Associates, L.P, is requesting approval of a site plan review application to facilitate construction of Central Pointe, a mixed-use development project consisting of two buildings with a total of 644 multi-family residential units, 15,130 square feet of commercial space, and associated amenities and open space at 1801 East Fourth Street. Staff is recommending approval of the applicant's request due to the project's compliance with the intent of the Metro East Mixed-Use Overlay Zone by providing a highly amenitized, mid-rise, mixed-use development within an urban environment.

**Table 1: Project and Location Information**

Item	Information
Project Address	1801 East Fourth Street
Nearest Intersection	Fourth Street and Cabrillo Park Drive
General Plan Designation	District Center (DC)
Zoning Designation	Metro East Mixed-Use Overlay Zone (MEMU), Active Urban (AU) district

Item	Information	
Surrounding Land Uses (Exhibit 2)	Commercial (North)	
	Commercial (East)	
	Commercial (South)	
	Santa Ana (I-5) Freeway and Commercial (West)	
Site Size	8.03 net acres	
Existing Site Development	Vacant	
Use Permissions	Mixed-use projects permitted by MEMU Overlay Section 4.1 Land Uses, Table 3, Section 4.1.3	
Code Sections Affected	Development Standards	MEMU Overlay, Sections 4.1 through 4.8
	Site Plan Review	MEMU Overlay, Sections 8

**Project Description**

The proposed project contains two buildings with an outdoor lawn in the center of the development. Each building includes five stories of residential units and ground-floor commercial space wrapped around seven levels of parking (one subterranean level and six above-grade levels) with a rooftop amenity deck. The total height of the project is approximately 86 feet. The project has a density of 81 dwelling units per acre and a floor area ratio of approximately 2.2. The unit mix varies from studio units, one-bedroom units, two-bedroom units, and three-bedroom units, with 12 different floor plans proposed. Residential common open space includes the private balconies or patios, the great lawn, nine courtyards, fitness rooms, club rooms, and a rooftop amenity deck with a pool and spa. Commercial spaces will line Fourth Street and provide opportunities for new eating establishments, service uses, and/or retail businesses. Publicly accessible open space includes the linear park along the east side of the development, a plaza at the corner of Fourth Street and Cabrillo Park Drive, and internal paseos. The outdoor areas will be programmed with picnic tables, benches, umbrellas, lawn games, decorative hardscape, a recreation trail, and landscaping.

Vehicular access to the site is provided from both Parkcourt Place and Fourth Street. Onsite parking includes 18 surface level parking spaces off of Fourth Street and a multi-level parking structure for each building. A total of 1,318 parking spaces are proposed which is a ratio of 2.04 spaces per unit. Offsite improvements include a new signalized intersection and crosswalks at Cabrillo Park Drive and Parkcourt Place. The existing median on Parkcourt Place will be reconstructed to provide a 100-foot left turn pocket to allow for vehicles to turn into the site as well as a dedicated left turn lane from Parkcourt Place to northbound Cabrillo Park Drive. The project will construct an additional westbound right-turn lane at Fourth Street and the northbound I-5 ramp and a dedicated right-turn lane on Cabrillo Park Drive. In addition, the project will also pay its fair share in modifying the eastbound shared through/right-turn lane to construct a free-right turn lane at the Fourth Street and southbound SR-55 ramp.

The building has been designed with contemporary architectural elements comprised of high quality, long lasting materials such as metal siding, stone veneer, simulated wood siding, fiber cement lap siding, fiber cement panels, stucco, metal and glass railings and aluminum storefronts (Exhibits 3 through 9).

**Table 2: Project Summary**

	Building A	Building B
Units	325 units	319 units
Commercial Square Footage (SF)	9,568 SF	5,562 SF
Building SF	286,655 SF	274,145 SF
Unit Mix/Room	19 studios (6%) 162 one-bedrooms (50%) 121 two-bedrooms (37%) 23 three-bedrooms (7%)	20 studios (6%) 164 one-bedrooms (51%) 127 two-bedrooms (40%) 8 three-bedrooms (3%)
Unit SF	518 to 543 SF studios 683 to 778 SF one-bedrooms 1,066 to 1,148 SF two-bedrooms 1,274 to 1,339 SF three-bedrooms	518 to 543 SF studios 683 to 778 SF one-bedrooms 1,066 to 1,148 SF two-bedrooms 1,274 to 1,339 SF three-bedrooms
Height & Stories	8-stories, 85'5"	8-stories, 85'5"
Parking	650 spaces (2.00 spaces per unit)	650 spaces (2.03 space per unit)
Open Space/ Amenities	Ground Level Courtyards 12,650 SF Roof Deck 15,961 SF Fitness and Club Room	Ground Level Courtyards 10,271 SF Roof Deck 15,961 SF Fitness and Club Room

**Project and Site Background**

The MEMU Overlay Zone was adopted in 2007 to facilitate mixed-used development opportunities in a portion of the City between the Santa Ana (I-5) and Costa Mesa (SR-55) freeways centered on First and Fourth streets. In 2018, the City approved an expansion of the MEMU Overlay Zone primarily along First Street to Grand Avenue that resulted in an additional 33 acres of potential mixed-use development.

In 2006, Shea Homes proposed a mixed-use project at the site consisting of almost 600 residential units, and 7,750 square feet of commercial space within a 5-story, 8-story and 20-story buildings. However, the due to economic conditions, the application was withdrawn. Currently, the project site is vacant and undeveloped.

In 2019, the applicant submitted plans to the development review committee and planning staff for review. Planning staff requested that the applicant maximize the amount of commercial space at the project, enhance the corner of Fourth Street and Cabrillo Park Drive, enhance the building materials, and increase in the number of parking spaces. A market analysis was completed for the project and evidenced that no more than 21,000 square feet can be successfully supported. The

applicant revised their initial proposal to increase the commercial square footage from 9,100 to 15,130 square feet, reflecting a 40 percent increase from the original proposal.

On October 12, 2020, the Planning Commission held a work study session to overview the project. A summary of the Commission's comments and the applicant's response to the comments is included in the table below.

**Table 3: October 12, 2020 Work Study Session Summary**

Commission Comment	Central Pointe Project
Provide adequate public open space on site	The Active Urban District requires that 15% of the site be publically accessible open space (52,468 SF required). The project meets the requirement by providing a total of 54,568 SF of publically accessible open space. The publically accessible open space includes the 31,596 SF linear park, plaza at Fourth St. and Cabrillo Park Dr., 15,727 SF central park, and forecourts as shown in Exhibit 9.
Provide adequate private/common area open space	The Active Urban District requires a total of 76,148 SF of private/common open space. The project exceeds the requirement by providing 106,654 SF of private/common open space through balconies for each unit, courtyards, rooftop amenity decks and a dog run as shown on the unit floor plans and on Exhibit 9.
Inclusion of larger trees and landscape at installation	The conceptual landscape plan includes a variety of tree species and sizes that are a minimum of 48-inch box trees. Condition of Approval No. 11 requires a minimum of 48-inch box trees and a minimum of a 10-foot brown truck height for the palm trees.
The viability of the commercial uses and intended goals of the MEMU	The Market and Fiscal Impact analysis and peer review of the study concluded that the project could support between 10,000 to 21,000 SF of commercial space. Additionally, a subsequent analysis on the feasibility of a neighborhood market on-site was conducted. The analysis concluded that it would be infeasible to include a market on-site Exhibit 15.
Parking for the commercial use	The Active Urban District requires 2.0 parking spaces per unit inclusive of nonresidential uses and guest parking (1,288 space required). The project exceeds this requirement by providing 1,318 spaces. Therefore, there are 30 additional parking spaces for the project (18 surface level parking spaces off Fourth Street adjacent to the commercial space and 12 spaces within the parking structures). The 30 additional spaces is a ratio of one parking space per every 500 square feet of commercial space. Condition of Approval No. 12 requires submittal of a parking management plan which will include management of parking for commercial and leasing office purpose and requires active monitoring of parking by the property manager.
Inclusion of green building features	The project will comply with the requirements of the CALGreen Building Code, which includes constructing a cool roof, electric vehicle charging stations, water and energy efficient fixtures and appliances, and drought tolerant plants and permeable surfaces. Energy efficient building construction elements include low/no VOC paint, highly rated insulation, and carbon absorbing framing.

**Analysis of the Issues**

*Site Plan Review*

The SAMC and Section 8.2 of the MEMU Overlay Zone require that the Planning Commission review a site plan review application for any project proposed within an overlay zone. An analysis of the required MEMU Overlay Findings and the project’s compliance with the MEMU is provided in Table 4 on the following page.

**Table 4: MEMU Findings for Site Plan Approval**

Finding	Project Compliance
<p>That the proposed development plan is consistent with and will further the objectives outlined in Section 1.2 for the MEMU Overlay Zone.</p>	<p>The development will activate a vacant and underutilized 8-acre site in the MEMU Overlay Zone. The project will create a new mixed-use development within close proximity to office buildings, Cabrillo Park, Mabury Park, and less than two miles from Downtown Santa Ana providing opportunities to live, work, and recreate. Each building will be five-stories of residential units wrapped around a seven-level parking structure. The height of the buildings will blend in with the heights of the nearby office buildings which range from single-story, three-story and eight-story buildings and will create an interface with the Santa Ana (I-5) Freeway.</p> <p>The project will be built to California Building Code standards, which include energy and water conservation measures and will improve pedestrian mobility by providing new sidewalks and parkways along Fourth Street and Parkcourt Place. In addition, the publically accessible linear park will serve as a link to the meandering trail along Mabury Street and to Mabury Park to the north. Each building has a centrally located bike room, and there is a rideshare pick-up/drop-off in the middle of the project site. Additionally, the project is within walking distance of the OCTA Route 463 bus stop at Fourth Street and Cabrillo Park Drive.</p> <p>The commercial space has been designed with retail floor heights of 20 feet with storefronts that will be visible from Fourth Street. In addition, the commercial space links directly to an on-site public plaza at the corner of Fourth Street and Cabrillo Park Drive which will include outdoor dining opportunities, decorative hardscape, specimen trees and plantings, umbrellas, seating and lawn games. In addition, the ground floor residential units along Cabrillo Park Drive will have doors and patios with direct access to the street to help activate the street.</p>
<p>That the proposed development plan is consistent with the development standards specified in Section 4 of the MEMU Overlay Zone.</p>	<p>The project is consistent with the development standards specified in Section 4 of the MEMU Overlay Zone including land use, stories, minimum development site area, building frontages, publically accessible open space, private/common open space, building setbacks, and parking and access. The propose project is a mixed-use development that has been well designed to fit within the Active Urban District. Further, the access and egress for the project has been thoroughly review by the Public works Agency for compliance with all applicable development standards.</p>
<p>That the proposed development plan is designed</p>	<p>The project is consistent with the development standards specified in Section 5 of the MEMU Overlay Zone. The building is designed with a high quality design that includes</p>



Finding	Project Compliance
<p>to be compatible with adjacent development in terms of similarity of scale, height, and site configuration and otherwise achieves the objectives of the Design Principles specified in Section 5 of the MEMU Overlay Zone.</p>	<p>varied massing, changes in form, and is comprised of high quality material including metal siding, stone veneer, simulated wood siding, fiber cement lap siding, fiber cement panels, stucco, metal and glass railings, and aluminum storefronts. During the development review process, the architectural design was peer reviewed by John Kaliski Architects and City staff, which resulted in higher-quality building materials, an increase in the commercial square footage and a plaza at the corner of Fourth Street and Cabrillo Park Drive. The project massing is broken into distinct building elements, facades are broken up with the inclusion of private balconies, courtyards, and contrasting building materials. The commercial storefronts are enhanced with cornices and metal canopies and the primary access to the commercial uses will be from Fourth Street. The project promotes pedestrian activity with landscaping and publically accessible open space. Parking areas are screened from the street. Lastly, over 40 percent of the units are over 1,000 square feet.</p>
<p>That the land use uses, site design, and operational considerations in the proposed development plan have been planned in a manner that will result in a compatible and harmonious operation as specified in Section 7 of the MEMU Overlay Zone.</p>	<p>The project is consistent with the development standards specified in Section 7 of the MEMU Overlay Zone. The project has been designed to ensure compatibility between the residential and non-residential uses on site. The commercial uses have separate entrances from the residential uses, and the parking management plan will manage parking between the residential and nonresidential uses. Each building has a dedicated move-in and commercial loading area that will be screened with roll-up doors and controlled by the property management company. On site lighting will be consistent with Chapter 8 of the Santa Ana Municipal Code (Building Security Ordinance).</p>

**California Environmental Quality Act (CEQA)**

The 2007 Metro East Mixed-Use Overlay Zone Environmental Impact Report (EIR) (SCH No. 2006031041) and 2018 Subsequent EIR (SEIR) anticipated potential development of 5,551 residential units, 963,000 square feet of commercial development, and 690,000 of office development. The 2007 EIR and 2018 SEIR analyzed impacts related to aesthetics, agriculture/forestry, air quality, biology, cultural resources, geology/soils, greenhouse gas emissions, hazards and hazardous materials, hydrology and water quality, land use and planning, mineral resources, noise, population/housing, public services, transportation/traffic, tribal cultural resources and utilities. The EIR and SEIR concluded that there would be significant and unavoidable impacts associated with air quality, noise, and transportation/traffic.

A traffic impact analysis was prepared for this project by Linscott Law and Greenspan which analyzed the projects impacts on 25 intersections. Of the 25 intersections studied, the intersections of (1) Fourth Street and the I-5 northbound ramp and (2) Fourth Street and the SR-55 southbound ramp are expected to have a significant impact under 2025 cumulative plus project conditions and 2040 buildout plus project conditions. As such, the off-site improvements listed in the anticipated development potential description above apply to the project to reduce impacts below a level of significance. In addition, a health risk assessment (HRA) was prepared by Urban Crossroads to

identify any impacts from developing a residential community near a major freeway. The HRA concluded that a less than significant impact to project residents would occur due to the project's proximity to a major freeway (Exhibits 11 and 12).

The Central Pointe development is within the range of development analyzed as part of the MEMU Overlay zone EIR and SEIR. The Mitigation Monitoring and Reporting Program of the MEMU EIR and SEIR applies to the project and will mitigate impacts below the level of significance.

### **Economic Development**

The applicant's retained the services of two economic consultants, The Concord Group and RSG, to prepare a market and fiscal impact analysis for the project (Exhibit 13). To validate the findings of the analysis, the City retained AECOM to peer review the applicants study (Exhibit 14).

The MEMU does not identify an amount of commercial space required for projects, only that development be mixed-use. Further, one of the objectives of the MEMU is to "facilitate project designs that encourage adequate amounts of retail or commercial space to service residents and/or employees within the development and the larger Metro East Overlay Zone area." The project proposes 15,130 square feet of commercial space. The applicant's study noted that the proposed 15,130 square feet would be sufficient to serve the project and MEMU area. The City's peer review estimates that the project could support between 10,000 and 21,000 square feet of commercial space; therefore, the proposed 15,130 square feet is within this range. Additionally, the proportion of commercial space to the overall size of the development is similar to the proportions approved for nearby mixed-use projects. The project proposes 2.6 percent of the total building square footage as commercial space. The three mixed-use projects within a half-mile of the project site either under construction or in the pipeline (The Madison, AMG First Point, and Elan) provide a similar proportion of commercial spaces at 1.4 to 3.5 percent of the total building square footage, while the Nineteen01 project provided a lower ratio. Unlike projects such as The Bowery, where no commercial space exists in the immediate area, this site is approximately ½ mile from Seventeenth Street, a main commercial corridor. This corridor contains a mixture of commercial uses, such as restaurants, dry cleaners, service stations and supermarkets. Additionally, a retail center located south of the site on East Fourth Street, although partially vacant, also provides retail opportunities in the MEMU zone.

AECOM estimates the following fiscal outcome over a 25-year forecast period:

- Approximately \$24.6 million in revenue to the City's General Fund (construction period revenues, recurring property tax revenue, utility user tax, residential sales tax and business tax)
- Approximately \$14.3 million in expenditures from the City General Fund (public services)
- The net new General Fund revenue is projected to be approximately \$10.3 million from the development of the project.

**Table 5: Public Notification and Community Outreach**

Public Notification and Community Outreach each	
Required Measures	<p>A community meeting was held on August 15, 2019 at 6:00 p.m. at Creekside Plaza, 505 N. Tustin Ave., Suite 243 in accordance with the provisions of the City's Sunshine Ordinance. Invitations/notices were mailed to property owners and occupants/tenants in a 500-foot radius from the project site. Approximately 15 members of the public attended, as well as two City staff. The applicant provided all the required information to the City after the meeting. Details from the community meeting were posted to the project's webpage at <a href="https://www.santa-ana.org/pb/planning-division/major-planning-projects-and-monthly-development-project-reports/central-pointe">https://www.santa-ana.org/pb/planning-division/major-planning-projects-and-monthly-development-project-reports/central-pointe</a> (Exhibit 16)</p> <p>On October 16, 2020 notification by mail was mailed to all property owners, occupants, and other interested parties within 500 feet of the project site in accordance with SAMC requirements. Newspaper posting was published in the Orange County Reporter in accordance with SAMC requirements.</p>
Additional Measures	<p>On October 22, 2020, the applicant provided an email update on the project to the members of the public that attended the Sunshine meeting.</p>

**Conclusion**

Based on the analysis provided within this report, staff recommends that the Planning Commission approve Site Plan Review No. 2020-04 as conditioned.

  
 Selena Kelaher, AICP  
 Associate Planner

SK:sb

S:\Planning Commission\2020\10-26-20\SPR No. 2020-04 - 1801 E. Fourth Street Central Pointe\SPR Central Pointe.pc 102620 AP.docx

**Exhibits:**

1. Resolution (Site Plan Review)
2. Vicinity Zoning and Aerial Map
3. Site Photos
4. Site Plan
5. Residential Unit Floor Plans
6. Building A Elevations
7. Building B Elevations
8. Renderings

9. Open Space Plan
10. Conformance to Development Standards
11. Health Risk Assessment
12. Traffic Impact Analysis
13. Market and Fiscal Analysis (The Concord Group)
14. Peer review of the Market and Fiscal Analysis (AECOM)
15. Neighborhood Market Feasibility
16. Sunshine Meeting Minutes

# **EXHIBIT 1**

1 - 10

RESOLUTION NO. 2020-xx

A RESOLUTION OF THE PLANNING COMMISSION OF THE CITY OF SANTA ANA APPROVING SITE PLAN REVIEW NO. 2020-04 AS CONDITIONED FOR A NEW MIXED-USE RESIDENTIAL AND COMMERCIAL DEVELOPMENT FOR THE PROPERTY LOCATED AT 1801 EAST FOURTH STREET

BE IT RESOLVED BY THE PLANNING COMMISSION OF THE CITY OF SANTA ANA AS FOLLOWS:

Section 1. The Planning Commission of the City of Santa Ana hereby finds, determines and declares as follows:

- A. Sean Rawson with Waterford Property Company, representing Park Center Santa Ana Associates, L.P (“Applicant”), is requesting approval of Site Plan Review No. 2020-04, as conditioned, to allow the construction of a new mixed-use development consisting of 644 multi-family residential units and 15,130 square feet of commercial space at 1801 East Fourth Street.
- B. The subject site has a General Plan land use designation of District Center (DC). The site is located within the Professional zoning district and has an overlay zone designation of Metro East Mixed-Use (MEMU) Overlay Zone (OZ-1), Active Urban district, which permits medium- to high-intensity mixed-use residential, commercial, office, and hotel developments subject to approval of a site plan review (SPR) application by the Planning Commission.
- C. The MEMU Overlay Zone was adopted in 2007 as a result of interest in developing mixed-use residential and commercial projects in the project area. In 2018, the City of Santa Ana expanded the MEMU designation along First Street between Grand Avenue and the Santa Ana (I-5) Freeway. The regulating plan, which establishes land uses and development standards, allows a variety of housing and commercial projects, including mixed-use residential communities, live/work units, hotels, and offices.
- D. On October 26, 2020, the Planning Commission of the City of Santa Ana held a duly noticed public hearing and at that time considered all testimony, written and oral for the project.
- E. Section 41-595.5 of the Santa Ana Municipal Code (SAMC) requires a review by the Planning Commission of all plans within a zoning district classification combined with an OZ suffix where the applicant wants to

apply the overlay zone, to ensure the project is in conformity with the overlay zone plan.

- F. The zoning designation for the subject property is proposed to be Metro East Mixed-Use (MEMU) Overlay Zone (OZ-1) in the Active Urban land use district.
  
- G. The Planning Commission determines that the following findings, which must be established in order to grant this Site Plan Review pursuant to SAMC Section 41-595.5, have been established for Site Plan Review No. 2020-04 to allow construction of the proposed project.
  - 1. That the proposed development plan is consistent with and will further the objectives outlined in Section 1.2 for the MEMU overlay district.

The development will activate a vacant and underutilized 8-acre site in the MEMU Overlay Zone. The project will create a new mixed-use development within close proximity to office buildings, Cabrillo Park, Mabury Park, and less than two miles from Downtown Santa Ana providing opportunities to live, work, and recreate. Each building will be five-stories of residential units wrapped around a seven-level parking structure. The height of the buildings will blend in with the heights of the nearby office buildings which range from single-story, three-story and eight-story buildings and will create an interface with the Santa Ana (I-5) Freeway.

The project will be built to California Building Code standards, which include energy and water conservation measures and will improve pedestrian mobility by providing new sidewalks, and parkways along Fourth Street and Parkcourt Place. In addition, the publically accessible linear park will serve as a link to the meandering trail along Mabury Street and to Mabury Park to the north. Each building has a centrally located bike room, and there is a rideshare pick-up/drop-off in the middle of the project site. Additionally, the project is within walking distance of the OCTA route 463 bus stop at Fourth Street and Cabrillo Park Drive.

The commercial space has been designed with retail floor heights of 20 feet with storefronts that will be visible from Fourth Street. In addition, the commercial space links directly to an on-site public plaza at the corner of Fourth Street and Cabrillo Park Drive which will include outdoor dining opportunities, decorative hardscape, specimen trees and plantings, umbrellas, seating and lawn games. In addition, the ground floor residential units along Cabrillo Park Drive will have doors and patios with direct access to the street to help activate the street.

2. That the proposed development plan is consistent with the development standards specified in Section 4 of the MEMU overlay district.

The project is consistent with the development standards specified in Section 4 of the MEMU Overlay Zone including land use, stories, development site area, building frontages, publically accessible open space, private/common open space, building setbacks, and parking.

3. That the proposed development plan is designed to be compatible with adjacent development in terms of similarity of scale, height, and site configuration and otherwise achieves the objectives of the Design Principles specified in Section 5 of the MEMU overlay district.

The project is consistent with the development standards specified in Section 5 of the MEMU Overlay Zone. The building is designed with a high quality design that includes varied massing, changes in form, and is comprised of high quality material including metal siding, stone veneer, simulated wood siding, fiber cement lap siding, fiber cement panels, stucco, metal and glass railings, and aluminum storefronts. During the development review process, the architectural design was peer reviewed by John Kaliski Architects and City staff, which resulted in higher-quality building materials, an increase in the commercial square footage and a plaza at the corner of Fourth Street and Cabrillo Park Drive. The project massing is broken into discrete building elements, facades are broken up with the inclusion of private balconies, courtyards, and contrasting building materials. The commercial storefronts are enhanced with cornices and metal canopies and the primary access to the commercial uses will be from Fourth Street. The project promotes pedestrian activity with landscaping and publically accessible open space. Parking areas are screened from the street. Lastly, over 40 percent of the units are over 1,000 square feet.

4. That the land use uses, site design, and operational considerations in the proposed development plan have been planned in a manner that will result in a compatible and harmonious operation as specified in Section 7 of the MEMU overlay district.

The project is consistent with the development standards specified in Section 7 of the MEMU Overlay Zone. The project has been designed to ensure compatibility between the residential and non-residential uses on site. The commercial uses have separate



entrances from the residential uses, and the parking management plan will manage parking between the residential and nonresidential uses. Each building has a dedicated move-in and commercial loading area that will be screened with roll-up doors and controlled by the property management company. On site lighting will be consistent with Santa Ana Municipal Code Chapter 8 (Security Ordinance).

Section 2. The Applicant shall indemnify, protect, defend and hold the City and/or any of its officials, officers, employees, agents, departments, agencies, authorized volunteers, and instrumentalities thereof, harmless from any and all claims, demands, lawsuits, writs of mandamus, and other and proceedings (whether legal, equitable, declaratory, administrative or adjudicatory in nature), and alternative dispute resolution procedures (including, but not limited to arbitrations, mediations, and such other procedures), judgments, orders, and decisions (collectively “Actions”), brought against the City and/or any of its officials, officers, employees, agents, departments, agencies, and instrumentalities thereof, that challenge, attack, or seek to modify, set aside, void, or annul, any action of, or any permit or approval issued by the City and/or any of its officials, officers, employees, agents, departments, agencies, and instrumentalities thereof (including actions approved by the voters of the City) for or concerning the project, whether such Actions are brought under the Ralph M. Brown Act, California Environmental Quality Act, the Planning and Zoning Law, the Subdivision Map Act, Code of Civil Procedure sections 1085 or 1094.5, or any other federal, state or local constitution, statute, law, ordinance, charter, rule, regulation, or any decision of a court of competent jurisdiction. It is expressly agreed that the City shall have the right to approve, which approval will not be unreasonably withheld, the legal counsel providing the City’s defense, and that Applicant shall reimburse the City for any costs and expenses directly and necessarily incurred by the City in the course of the defense. City shall promptly notify the Applicant of any Action brought and City shall cooperate with Applicant in the defense of the Action.

Section 3. In accordance with the California Environmental Quality Act (CEQA), the project has been determined to be adequately evaluated in the previously certified Environmental Impact Report (EIR) No. 2006-01 (SCH No. 2006031041) and Subsequent EIR SEIR No. 2018-15 as per Sections 15162 and 15168 of the CEQA guidelines. All mitigation measures in EIR No. 2006-01 and SEIR No. 2018-15 and associated Mitigation Monitoring and Reporting Program (MMRP) will be enforced and apply to the proposed project. In addition, a traffic impact analysis dated July 30, 2020 was also prepared by Linscott Law and Greenspan which analyzed the projects impacts on 25 intersections. The off-site improvements listed the Traffic Impact Analysis shall be implemented. A health risk assessment (HRA) was prepared to identify any impacts from developing a residential community near a major freeway. The HRA finds that a less than significant impact to project residents would occur due to the project’s proximity to a major freeway.

Section 4. The Planning Commission of the City of Santa Ana, after conducting the public hearing, hereby approves Site Plan Review No. 2020-04 as conditioned in

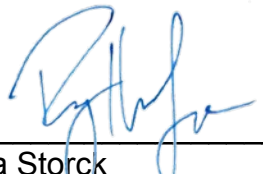
Exhibit A attached hereto and incorporated as though fully set forth herein. This decision is based upon the evidence submitted at the above said hearing, which includes, but is not limited to: the Request for Planning Commission Action dated October 26, 2020, and exhibits attached thereto; and the public testimony, written and oral, all of which are incorporated herein by this reference.

ADOPTED this 26<sup>th</sup> day of October, 2020 by the following vote:

AYES: Commissioners:  
NOES: Commissioners:  
ABSENT: Commissioners:  
ABSTENTIONS: Commissioners:

\_\_\_\_\_  
Mark McLoughlin  
Chairman

APPROVED AS TO FORM:  
Sonia R. Carvalho, City Attorney

By:  for \_\_\_\_\_  
Lisa Storck  
Assistant City Attorney

CERTIFICATE OF ATTESTATION AND ORIGINALITY

I, SARAH BERNAL Recording Secretary, do hereby attest to and certify the attached Resolution No. 2020-XXXX to be the original resolution adopted by the Planning Commission of the City of Santa Ana on October 26, 2020.

Date: \_\_\_\_\_

\_\_\_\_\_  
Recording Secretary  
City of Santa Ana

## **Conditions for Approval for Site Plan Review No. 2020-04**

Site Plan Review No. 2020-04 is approved subject to compliance, to the reasonable satisfaction of the Planning Manager, with applicable sections of the Santa Ana Municipal Code, the California Administrative Code, the California Building Standards Code, and all other applicable regulations. In addition, it shall meet the following conditions of approval:

The Applicant must comply with each and every condition listed below prior to exercising the rights conferred by this site plan review.

The Applicant must remain in compliance with all conditions listed below throughout the life of the development project. Failure to comply with each and every condition may result in the revocation of the site plan review.

### **A. Planning Division**

1. All proposed site improvements must conform to the Development Project Review approval of DP No. 2019-26, and the staff report exhibits incorporated herein by reference.
2. Developer shall agree to all recommendations contained within the required technical studies and reports prepared for the project including the Traffic Impact Analysis dated July 30, 2020. All studies and reports shall be finalized by the Developer and approved by the City of Santa Ana prior to issuance of building permits.
3. Any amendment to this site plan review, including modifications to approved materials, finishes, architecture, site plan, landscaping, unit count, mix, and square footages must be submitted to the Planning Division for review. At that time, staff will determine if administrative relief is available or if the site plan review must be amended.
4. The full volume (first and second levels) of the commercial square footage within both buildings along Fourth Street shall be maintained for commercial purposes only and may not be converted or used for residential purposes.
5. The publicly accessible open space areas as shown on the open space plan shall remain accessible to the public and include a combination of landscape and hardscape as specified in Section 4.5 of the Metro East Mixed-Use Overlay Zone requirements.
6. A residential property manager shall be available at all times that the Project is occupied and Developer and onsite management shall at all times maintain a 24-hour emergency contact and contact information on file with the City that is also posted at the entrance to the leasing office for public view.

7. All Project mechanical equipment shall be screened from view from public and courtyard areas.
8. After Project occupancy, landscaping and hardscape materials must be maintained as shown on the approved landscape plans.
9. Prior to the issuance of any building permits the subject site must meet the requirements of the Subdivision Map Act (i.e. a Lot Merger or Parcel Map must be recorded for the subject property).
10. Prior to issuance of any building permits, a final detailed amenity plan must be reviewed and approved by Developer and the Planning Division. The plan shall include details on the hardscape design, lighting concepts and outdoor furniture for amenity, plaza, or courtyard areas, as well as an installation plan.
11. Prior to issuance of building permits, the Developer shall submit a construction schedule and staging plan to the Planning Division for review and approval. The plan shall include construction hours, staging areas, parking and site security/screening during Project construction.
12. Prior to installation of landscaping, the Developer shall submit photos and specifications of all trees to be installed on the Project site for review and approval by the Planning Division. Specifications shall include, at a minimum, the species, box size (48 inches minimum), brown trunk height (10-foot minimum), and name and location of the supplier.
13. Developer shall provide onsite parking for residents and visitors of the Project and actively monitor the parking demand of the Project site. Developer shall take continually monitor and take appropriate measures to manage the parking demand of the Project site to mitigate the use of offsite parking spaces on private or public properties and/or right-of-way. Prior to issuance of the certificate of occupancy and/or building permit finals, Developer shall submit and obtain approval from the Planning and Building Agency a Parking Management Plan (the "PMP") meeting the requirements of this condition. The approved PMP shall be adhered to and be enforced by the Project at all times.
14. Prior to Certificate of Occupancy issuance, public art shall be installed on the Project site at a value of one-half of one percent (0.5%) of the total valuation of both buildings. The selection, design, and installation of the art shall be subject to review and approval by the Planning and Building Agency, the Community Development Agency, and the Applicant.
15. Prior to Certificate of Occupancy issuance, a Property Maintenance Agreement must be recorded against the property. The agreement will be subject to review and applicability by the Planning and Building Agency, the Community Development Agency, the Public Works Agency, and the City Attorney to ensure

that the property and all improvements located thereupon are properly maintained, Developer (and the owner of the property upon which the authorized use and/or authorized improvements are located if different from the Applicant) shall execute a Maintenance Agreement with the City of Santa Ana which shall be recorded against the property and which shall be in a form reasonably satisfactory to the City Attorney. The Maintenance Agreement shall contain covenants, conditions and restrictions relating to the following:

(a) Compliance with operational conditions applicable during any period(s) of construction or major repair (e.g., proper screening and securing of the construction site; implementation of proper erosion control, dust control and noise mitigation measure; adherence to approved project phasing etc.);

(b) Compliance with ongoing operational conditions, requirements and restrictions, as applicable (including but not limited to hours of operation, security requirements, the proper storage and disposal of trash and debris, enforcement of the parking management plan, and/or restrictions on certain uses,

(c) Ongoing compliance with approved design and construction parameters, signage parameters and restrictions as well as landscape designs, as applicable;

(d) Ongoing maintenance, repair and upkeep of the property and all improvements located thereupon (including but not limited to controls on the proliferation of trash and debris about the property; the proper and timely removal of graffiti; the timely maintenance, repair and upkeep of damaged, vandalized and/or weathered buildings, structures and/or improvements; the timely maintenance, repair and upkeep of exterior paint, parking striping, lighting and irrigation fixtures, walls and fencing, publicly accessible bathrooms and bathroom fixtures, landscaping and related landscape improvements and the like, as applicable);

(e) If Developer and the owner of the property are different (e.g., if the Applicant is a tenant or licensee of the property or any portion thereof), both the Applicant and the owner of the property shall be signatories to the Maintenance Agreement and both shall be jointly and severally liable for compliance with its terms.

(f) The Maintenance Agreement shall further provide that any party responsible for complying with its terms shall not assign its ownership interest in the property or any interest in any lease, sublease, license or sublicense, unless the prospective assignee agrees in writing to assume all of the duties, obligations and responsibilities set forth under the Maintenance Agreement.

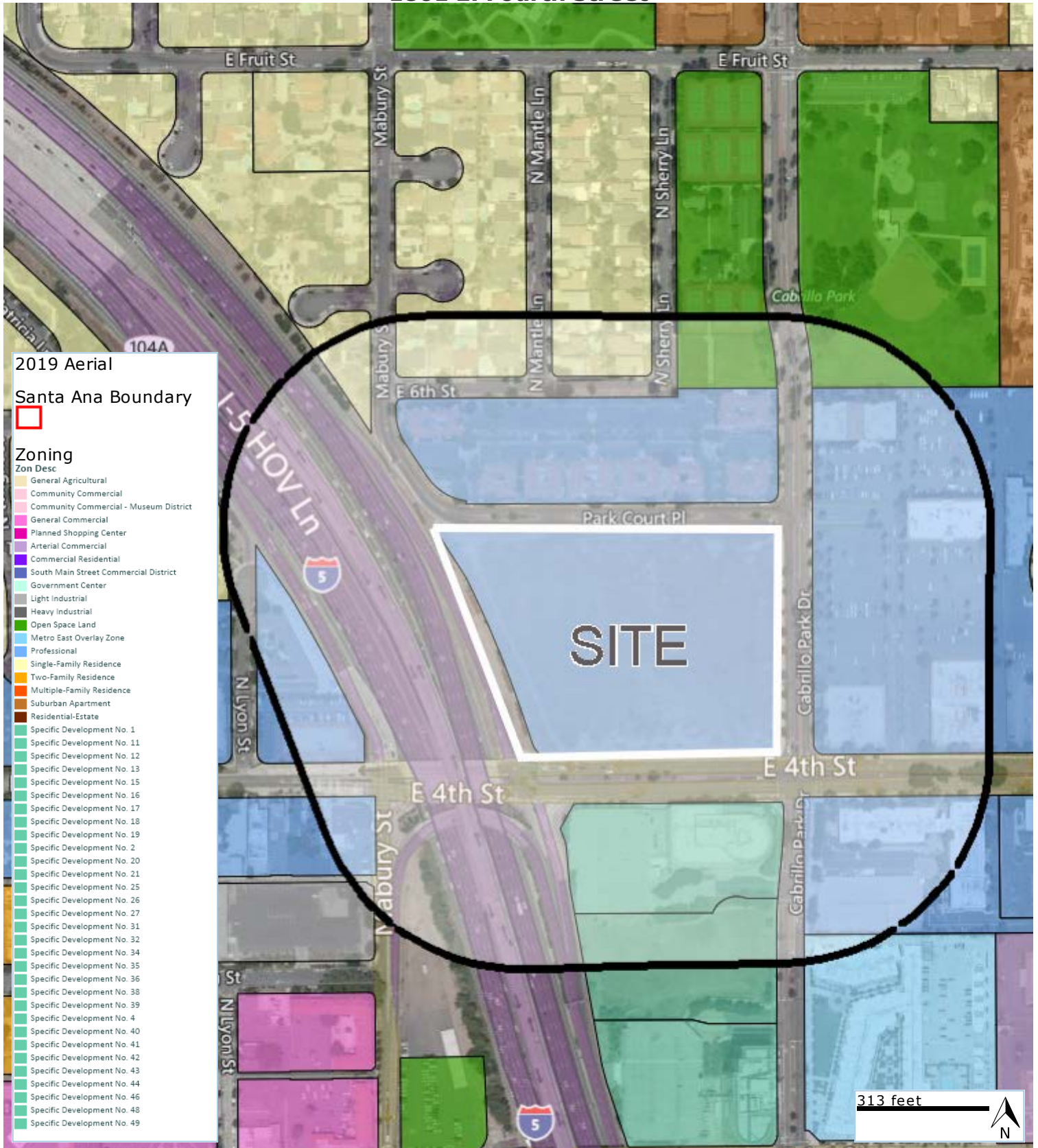
(g) The Maintenance Agreement shall contain provisions relating to the enforcement of its conditions by the City and shall also contain provisions authorizing the City to recover costs and expenses which the City may incur arising out of any enforcement and/or remediation efforts which the City may

undertake in order to cure any deficiency in maintenance, repair or upkeep or to enforce any restrictions or conditions upon the use of the property. The maintenance agreement shall further provide that any unreimbursed costs and/or expenses incurred by the City to cure a deficiency in maintenance or to enforce use restrictions shall become a lien upon the property in an amount equivalent to the actual costs and/or expense incurred by the City.

(h) The execution and recordation of the Maintenance Agreement shall be a condition precedent to the issuance of final approval for any construction permit related to this entitlement.

# **EXHIBIT 2**

**Central Pointe Mixed-Use Project SPR No. 2020-04  
1801 E. Fourth Street**



**Exhibit 2 – Vicinity Zoning and Aerial View**





# **EXHIBIT 3**

1 - 22



SPR No. 2020-04  
1801 East Fourth Street  
Central Pointe Mixed-Use Development  
**Exhibit 3 – Site Photos**

# **EXHIBIT 4**

1 - 24



# **EXHIBIT 5**

1 - 26



SPR No. 2020-04  
 1801 East Fourth Street  
 Central Pointe Mixed-Use Development  
**Exhibit 5 – Residential Unit Floor Plans**



Plan 1-5  
1 Bedroom / 1 Bathroom  
831 SQ. FT.



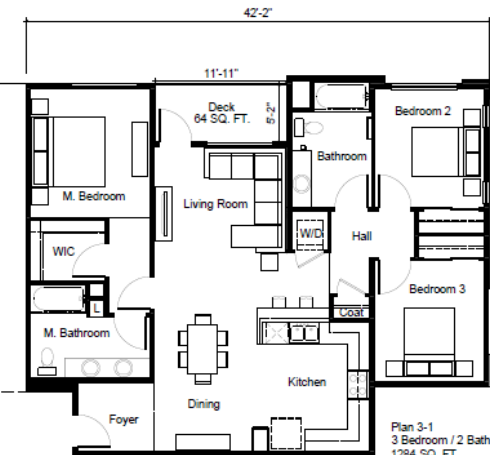
Plan 2-1  
2 Bedroom / 2 Bathroom  
1,088 SQ. FT.



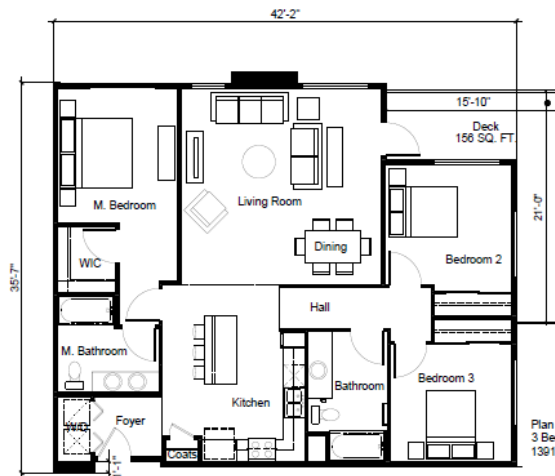
Plan 2-2  
2 Bedroom / 2 Bathroom  
1,148 SQ. FT.



Plan 2-3  
2 Bedroom / 2 Bathroom  
1,071 SQ. FT.



Plan 3-1  
3 Bedroom / 2 Bathroom  
1,284 SQ. FT.



Plan 3-2  
3 Bedroom / 2 Bathroom  
1,381 SQ. FT.

SPR No. 2020-04  
1801 East Fourth Street  
Central Pointe Mixed-Use Development  
**Exhibit 5 – Residential Unit Floor Plans**

# **EXHIBIT 6**

1 - 29





1. 4th Street Elevation (South)



Note: Refer to Material Boards for color and material information.

2. Cabrillo Park Drive Elevation (East)



3. Parkcourt Place Elevation (North)



Note: Refer to Material Boards for color and material information.

4. Site Interior Elevation (West)

SPR No. 2020-04  
 1801 East Fourth Street  
 Central Pointe Mixed-Use Development  
**Exhibit 6 – Building A Elevations**

# **EXHIBIT 7**

1 - 31



1. 4th Street Elevation (South)



2. Freeway Frontage Elevation (West)



3. Parkcourt Place Elevation (North)



Note: Refer to Material Boards for color and material information.

4. Site Interior Elevation (West)

SPR No. 2020-04  
 1801 East Fourth Street  
 Central Pointe Mixed-Use Development  
**Exhibit 7 – Building B Elevations**

# **EXHIBIT 8**

1 - 33



SPR No. 2020-04  
1801 East Fourth Street  
Central Pointe Mixed-Use Development  
**Exhibit 8 – Renderings**

# **EXHIBIT 9**

1 - 35

**Publicly Accessible Open Space:**

Gross Site Area 8.35 Acres  
 Net Site Area 8.03 Acres

Requirement: 50,468 sf required  
 15% of net site area

Proposed: (Area shown hatched)

PAOS	Area (sf)
Forecourt A1	4,703
Forecourt A2	1,306
Forecourt A3	1,216
Linear Park	11,577
<b>Total PAOS</b>	<b>184,568 sf proposed</b>

Note: 13,880 sf of Structure and "Paved" Paved" not counted toward required PAOS

**Private/Common Open Space:**

Requirement #1: 67,960 sf

Requirement #2: 18,158 sf

Total Req'd: 76,118 sf

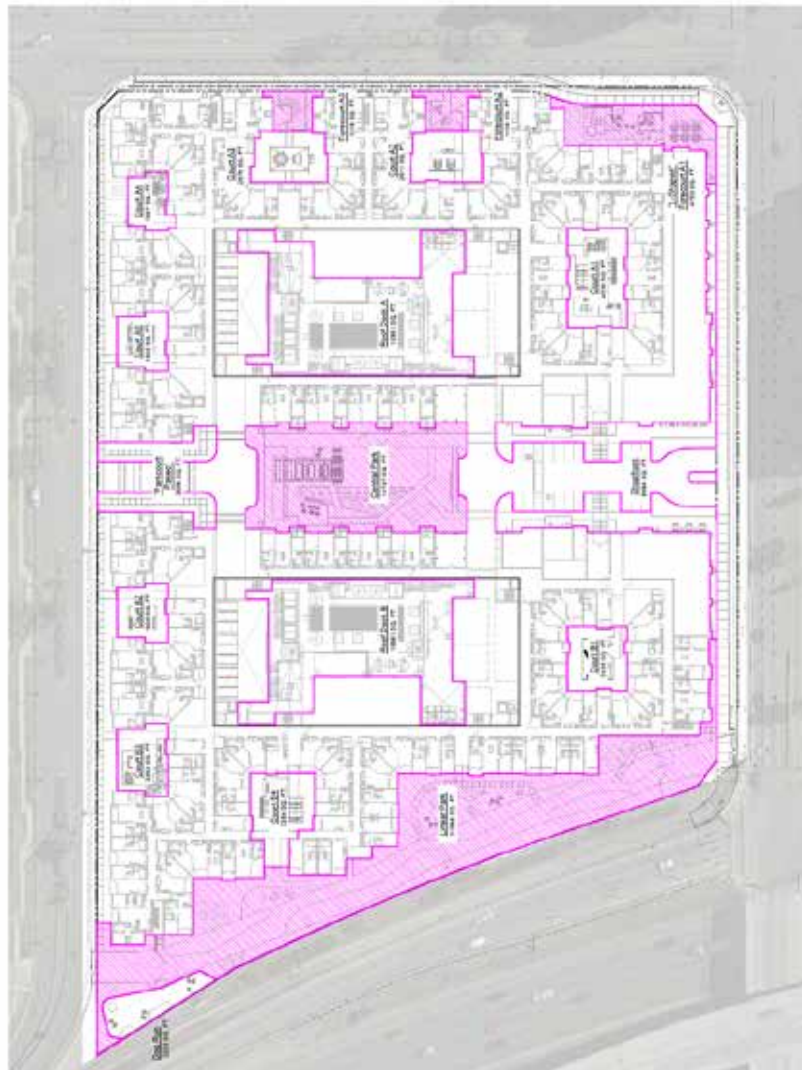
Proposed:

Open Space	Area (sf)	Total Proposed
Priv. Open Space	40,388	216,654
Courtyard A1	2,511	
Courtyard A2	2,579	
Courtyard A3	1,995	
Courtyard A4	2,636	
Courtyard B1	1,900	
Courtyard B2	2,362	
Courtyard B3	3,354	
Courtyard B4	2,223	
Dog Run	15,361	
Roof Deck A	15,361	
Roof Deck B	15,361	
<b>Total Proposed</b>	<b>216,654</b>	

**Legend**



Publicly Accessible Open Space



SPR No. 2020-04  
 1801 East Fourth Street  
 Central Pointe Mixed-Use Development  
**Exhibit 9 – Open Space Plan**

# EXHIBIT 10

1 - 37



## Development Standards

<b>Standard</b>	<b>Required by MEMU Active Urban</b>	<b>Provided</b>
Land Uses	Mixed-Use Development	644 multi-family residential units and 15,130 SF of commercial space
Maximum Stories	3 minimum No maximum	Complies; 5 stories residential 7 level parking structure and amenity deck
Minimum Development Size	1 acre	Complies; 8.03 acres net
Street Level Building Frontages	Forecourt, Shopfront, Gallery or Arcade	Forecourt and Shopfront
Publicly Accessible Open Space	15% of lot area (52,468 sq. ft.)	Complies; 15% (52,521 SF)
Private and Common Open Space	90 SF per unit and 5% of site area for non-residential uses (58,716 SF)	Complies; 106,654 SF
Building to Street	10 feet maximum	Complies; 10 feet maximum
Building to Property Line	5 feet adjacent to any other use	N/A – no immediately adjacent uses
Building to Building	15 feet minimum between buildings	Complies; 95 feet between buildings
Parking	2.0 per unit inclusive of guest and non-residential SF (1,288 spaces)	Complies; 2.04 spaces/unit (1,318 spaces)

SPR No. 2020-04  
 1801 East Fourth Street  
 Central Pointe Mixed-Use Development  
**Exhibit 10 – Development Standards**

# EXHIBIT 11

1 - 39



---

# Central Pointe Mixed-Use Development

**DIESEL PARTICULATE MATTER (DPM) HEALTH RISK ASSESSMENT  
CITY OF SANTA ANA**

PREPARED BY:

Haseeb Qureshi  
hqureshi@urbanxroads.com  
(949) 336-5987

JUNE 5, 2020

---

13400-03 Freeway HRA Report

SPR No. 2020-04  
1801 East Fourth Street  
Central Pointe Mixed-Use Development  
Exhibit 11 - Health Risk Assessment



## **TABLE OF CONTENTS**

<b>TABLE OF CONTENTS</b> .....	<b>I</b>
<b>APPENDICES</b> .....	<b>II</b>
<b>LIST OF EXHIBITS</b> .....	<b>III</b>
<b>LIST OF TABLES</b> .....	<b>III</b>
<b>LIST OF ABBREVIATED TERMS</b> .....	<b>IV</b>
<b>EXECUTIVE SUMMARY</b> .....	<b>5</b>
<b>1 INTRODUCTION</b> .....	<b>7</b>
1.1 Site Location.....	7
1.2 Project Description.....	7
<b>2 SOURCE IDENTIFICATION</b> .....	<b>10</b>
<b>3 SOURCE CHARACTERIZATION</b> .....	<b>12</b>
<b>4 EXPOSURE QUANTIFICATION</b> .....	<b>15</b>
<b>5 RISK CHARACTERIZATION</b> .....	<b>17</b>
5.1 Carcinogenic Chemical Risk.....	17
5.2 Non-Carcinogenic Exposures .....	18
5.3 Potential Cancer and Non-Cancer Risks.....	19
<b>6 REFERENCES</b> .....	<b>21</b>
<b>7 CERTIFICATION</b> .....	<b>23</b>

## **APPENDICES**

**APPENDIX 3.1: EMISSION RATE CALCULATION WORKSHEETS**

**APPENDIX 3.2: RISK CALCULATION WORKSHEETS**

**APPENDIX 4.1: AERMOD MODEL OUTPUT SUMMARY FILE**

**APPENDIX 4.2: AERMOD MODEL INPUT/OUTPUT FILES  
(ELECTRONIC FORMAT, AVAILABLE ON REQUEST)**

**LIST OF EXHIBITS**

EXHIBIT 1-A: LOCATION MAP .....8  
EXHIBIT 4-A: SOURCE RECEPTOR GRID NETWORK .....16

**LIST OF TABLES**

TABLE 2-1 FREEWAY TRAFFIC VOLUMES .....10  
TABLE 3-1: VEHICLE FLEET MIX PROFILE .....13

## **LIST OF ABBREVIATED TERMS**

(1)	Reference
AADT	Annual Average Daily Traffic Volumes
ARB	Air Resources Board
CAAQS	California Ambient Air Quality Standards
Caltrans	California Department of Transportation
CEQA	California Environmental Quality Act
CO	Carbon Monoxide
CPF	Cancer Potency Factor
EPA	Environmental Protection Agency
HRA	Health Risk Assessment
LDA	Light Duty Auto
LDT	Light Duty Truck
LHD	Light Heavy Duty
MCY	Motorcycle
MDV	Medium Duty Vehicle
NO <sub>2</sub>	Nitrogen Dioxide
OBUS	Other Bus
OLM	Ozone Limiting
PM <sub>10</sub>	Particulate Matter 10 microns in diameter or less
PM <sub>2.5</sub>	Particulate Matter 2.5 microns in diameter or less
PPM	Parts per Million
Project	Central Pointe Mixed-Use Development
PVMRM	Plume Volume Molar Ratio Methods
REL	Reference Exposure Level
RME	Reasonable Maximum Exposure
SBUS	School Bus
SCAQMD	South Coast Air Quality management District
TACs	Toxic Air Contaminants
UBUS	Urban Bus
URF	Unit Risk Factor
UTM	Universal Traverse Mercator



## EXECUTIVE SUMMARY

In 2005, the California Air Resources Board (ARB) promulgated an advisory recommendation to avoid setting sensitive land uses within 500 feet of a freeway, urban roads with 100,000 vehicles per day, or rural roads with 50,000 vehicles per day. The ARB indicates that due to traffic-generated pollutants, there is an estimated increased cancer risk incidence of 300 to 1,700 per million in within this domain. At some point however, the increased cancer risk incidence due the effects of freeway/roadway corridor pollutants become indistinguishable from the ambient air quality condition. In this regard, the effects of freeway/roadway-source pollutants that may impact the Project site are already acknowledged and accounted for within the ambient air quality discussions presented within this Section. More specifically, the MATES-IV Study data for the Project site comprehensively reflects increased TAC-source cancer risks affecting the City and Project site, inclusive of increased cancer risks due to freeway sources.

The 2005 ARB guidance noted previously, information made available through the MATES-IV Study, and configuration and design of the Project would suggest that further assessment of freeway-source pollutant impacts is not warranted. Notwithstanding, this Off-Site Freeway-Source Air Toxic Health Risk Assessment has been prepared for the Project and is intended to:

- Comply with and support CEQA Section 15003 (i) policies addressing adequacy, completeness, and a good-faith effort at full disclosure;
- Disaggregate potential freeway-source air pollutant health effects from other background conditions identified in the MATES IV Study; and
- Identify means to reduce the specific effects of freeway-source pollutants at the Project site.

Findings and conclusions of this Assessment are summarized below.

### SUMMARY OF FINDINGS

For carcinogenic exposures resulting from exposure to toxics from the freeway, the summation of risk for the maximum exposed residential receptor totaled 3.58 in one million and will not exceed the SCAQMD significance threshold of 10 in one million.

For chronic noncarcinogenic effects, the hazard index identified for each toxicological endpoint totaled less than one. For acute exposures, the hazard indices for the identified averaging times did not exceed unity. Therefore, noncarcinogenic hazards are calculated to be within acceptable limits and a less than significant impact would occur.

*This page intentionally left blank*

## 1 INTRODUCTION

In 2005, the California Air Resources Board (ARB) promulgated an advisory recommendation to avoid setting sensitive land uses within 500 feet of a freeway, urban roads with 100,000 vehicles per day or rural roads with 50,000 vehicles per day. According to the ARB, the increased cancer risk is 300 to 1,700 per million within this domain. The strongest association of traffic related emissions with adverse health outcomes was seen within 300 feet of roadways with high truck densities. Notwithstanding, the ARB notes that a site-specific analysis would be required to determine the actual risk near a particular land use and should consider factors such as prevailing wind direction, local topography and climate.

In consideration of the above referenced requirement, the assessment and dispersion modeling methodologies used in the preparation of this report were composed of all relevant and appropriate procedures presented by the U.S. Environmental Protection Agency, California Environmental Protection Agency and South Coast Air Quality Management District (SCAQMD). The methodologies and assumptions offered under this regulatory guidance were used to ensure that the assessment effectively quantified residential exposures associated with the generation of contaminant emissions from adjacent mobile source activity.

This report summarizes the protocol used to evaluate contaminant exposures and presents the results of the health risk assessment (HRA) prepared by Urban Crossroads, Inc., for the proposed Central Pointe Mixed-Use Development (referred to as "Project").

### 1.1 SITE LOCATION

The proposed Project is located at 1801 E Fourth Street at the northwest corner of 4<sup>th</sup> Street and Cabrillo Park Drive in the City of Santa Ana within the Metro East Mixed-Use (MEMU) Overlay District, as shown on Exhibit 1-A.

### 1.2 PROJECT DESCRIPTION

The Project is proposed to consist of up to 650 multi-family residential units and 8,800 square feet of commercial space on an approximately 8-acre site.

As part of the project design, the Project applicant has agreed to installing and maintaining air filtration systems with efficiencies equal to or exceeding a Minimum Efficiency Reporting Value (MERV) 13 as defined by the American Society of Heating, Refrigerating and Air Conditioning Engineers (ASHRAE) Standard 52.2. (1)<sup>1</sup> in the proposed multi-family residential dwelling units.

---

1 The use of MERV filtration systems to reduce DPM and particulates has been successfully implemented by several lead agencies, including, but not limited to: City of Los Angeles, City of Claremont, City of Irvine, City of Glendale, City of Berkeley, City of Oakland, and the Los Angeles Unified School District (LAUSD). The average particle size efficiency (PSE) removal based on ASHRAE Standard 52.2 for MERV 13 is approximately 75% for 0.3 to 1.0  $\mu\text{g}/\text{m}^3$ (DPM) (2).

EXHIBIT 1-A: LOCATION MAP



*This page intentionally left blank*

## 2 SOURCE IDENTIFICATION

The California Department of Transportation (Caltrans), Traffic and Vehicle Data Systems Unit collects and maintains traffic volume counts for vehicles traversing the California state highway system. Table 2-1 presents the annual average daily traffic volumes (AADT) for the freeway segment considered in the assessment.

**TABLE 2-1 FREEWAY TRAFFIC VOLUMES**

Roadway Segment	AADT	Vehicles Per Hour (ALL)	Vehicles Per Hour (gas)	Vehicles Per Hour (diesel)
I-5 Freeway	329,500	13,729	13,189	540

*This page intentionally left blank*

### 3 SOURCE CHARACTERIZATION

In urban communities, vehicle emissions contribute significantly to localized concentrations of air contaminants. Typically, emissions generated from these sources are characterized by vehicle mix, the rate pollutants are generated during the course of travel and the number of vehicles traversing the roadway network.

Currently, emission factors are generated from a series of computer based programs to produce a composite emission rate for vehicles traveling at various speeds within a defined geographical area or along a discrete roadway segment. To account for the emission standards imposed on the California fleet, the ARB has developed the EMFAC2017 emission factor model. EMFAC2017 was utilized to identify pollutant emission rates for total organic gases (TOG), diesel particulates, particulates (PM10 and PM2.5), carbon monoxide (CO) and nitrogen oxide (NOx) compounds (2). To produce a representative vehicle fleet distribution, the assessment utilized ARB's Orange County population estimates for the 2020 calendar year. This approach provides an estimate of vehicle mix associated with operational profiles at the link or intersection level. Table 3-1 lists the identified fleet mix considered in the assessment.

Based upon the freeway traffic volumes and population profiles noted above, discrete traffic counts were identified for each roadway segment. Diesel vehicles account for 3.94 percent of the total on-road mobile fleet. For chronic (long term) exposures, AADT values were averaged to produce representative hourly traffic volumes.

An average observed route speed of 65 miles per hour was assumed for vehicles traversing the main highway link (I-5).

The focus of this HRA is on DPM associated with vehicular activity traversing I-5. Appendix 3.1 presents the on-road emission rate calculation worksheets for the freeway segment considered in the assessment.



**TABLE 3-1: VEHICLE FLEET MIX PROFILE**

Vehicle class	Orange County		
	Fuel	Population	Percent
LDA	Diesel	11,165	0.43
LDA	Gas	1,247,860	51.75
LDT1	Diesel	56	0.00
LDT1	Gas	134,019	5.46
LDT2	Diesel	2,427	0.07
LDT2	Gas	447,358	16.58
LHD1	Diesel	21,630	1.54
LHD1	Gas	36,819	1.59
LHD2	Diesel	8,344	0.58
LHD2	Gas	6,427	0.22
MCY	Gas	55,869	2.69
MDV	Diesel	6,029	0.25
MDV	Gas	312,580	15.17
MH	Diesel	2,902	0.20
MH	Gas	7,043	0.55
T6	Diesel	27,487	1.17
T6	Gas	7,555	0.12
T7	Diesel	10,494	1.42
T7	Gas	10	0.00
OBUS	Diesel	618	0.02
OBUS	Gas	996	0.04
SBUS	Diesel	1,330	0.08
SBUS	Gas	478	0.04
UBUS	Diesel	0	0.00
UBUS	Gas	210	0.02

Note: Vehicle category descriptions can be found on the California Air Resources Board website at <http://www.arb.ca.gov/msei/modeling.htm>.

*This page intentionally left blank*

## 4 EXPOSURE QUANTIFICATION

In order to assess the impact of emitted compounds on individuals who reside at the proposed apartment complex, air quality modeling utilizing the AMS/EPA Regulatory Model AERMOD was performed to assess the downwind extent of mobile source emissions. AERMOD's air dispersion algorithms are based upon a planetary boundary layer turbulence structure and scaling concepts, including the treatment of surface and elevated sources in simple and complex terrain.

The model offers additional flexibility by allowing the user to assign initial vertical and lateral dispersion parameters for sources representative of a localized mobile fleet. For this assessment, the volume source algorithm was utilized to model the emissions generated from on-road mobile source activity.

Air dispersion models require additional input parameters including pollutant emission data and local meteorology. Due to their sensitivity to individual meteorological parameters such as wind speed and direction, the U.S. Environmental Protection Agency recommends that meteorological data used as input into dispersion models be selected on the basis of relative spatial and temporal conditions that exist in the area of concern. In response to this recommendation, the nearest meteorological data available from the SCAQMD John Wayne Airport Meteorological Data Station (Source Receptor Area 18), was used to represent local weather conditions and prevailing winds. Five years (2012-2016) of available AERMOD meteorological data was utilized in the modeling.

The modeling analysis also considered the spatial distribution of mobile source activity traversing the freeway in relation to the proposed site. To accommodate a Cartesian grid format, direction dependent calculations were obtained by identifying the universal transverse mercator (UTM) coordinates for each volume source location. On-site receptors were placed to provide coverage across the identified residential portion of the site. A ground level receptor height was assumed as a conservative measure. A graphical representation of the source-receptor grid network is presented in Exhibit 4-A.

A dispersion model input summary table is provided in Appendix 4.1. A complete listing of model input/output files are provided in electronic format in Appendix 4.2.



## 5 RISK CHARACTERIZATION

### 5.1 CARCINOGENIC CHEMICAL RISK

The SCAQMD CEQA Air Quality Handbook (1993) states that emissions of toxic air contaminants (TACs) are considered significant if a HRA shows an increased risk of greater than ten in one million. Based on guidance from the SCAQMD in the document Health Risk Assessment Guidance for Analyzing Cancer Risks from Mobile Source Diesel Idling Emissions for CEQA Air Quality Analysis (3), for purposes of this analysis, ten (10) in one million is used as the cancer risk threshold for the proposed Project.

Excess cancer risks are estimated as the upper-bound incremental probability that an individual will develop cancer over a lifetime as a direct result of exposure to potential carcinogens over a specified exposure duration. The estimated risk is expressed as a unitless probability. The cancer risk attributed to a chemical is calculated by multiplying the chemical intake or dose at the human exchange boundaries (e.g., lungs) by the chemical-specific cancer potency factor (CPF). A risk level of 1 in a million implies a likelihood that up to one person, out of one million equally exposed people would contract cancer if exposed continuously (24 hours per day) to the levels of toxic air contaminants over a specified duration of time. This risk would be an excess cancer risk that is in addition to any cancer risk borne by a person not exposed to these air toxics.

Health risks associated with exposure to carcinogenic compounds can be defined in terms of the probability of developing cancer as a result of exposure to a chemical at a given concentration. Under a deterministic approach (i.e., point estimate methodology), the cancer risk probability is determined by multiplying the chemical's annual concentration by its unit risk factor (URF). The URF is a measure of the carcinogenic potential of a chemical when a dose is received through the inhalation pathway. It represents an upper bound estimate of the probability of contracting cancer as a result of continuous exposure to an ambient concentration of one microgram per cubic meter ( $\mu\text{g}/\text{m}^3$ ) over a 70 year lifetime. The URFs utilized in the assessment and corresponding cancer potency factors were obtained from the *Consolidated Table of OEHHA/ARB Approved Risk Assessment Health Values*.

Notwithstanding, it is the intent of the HRA to provide risk estimates from near-field on-road sources that are reflective of anticipated exposures experienced at a given residential occupancy. As such, a review of relevant guidance was conducted to determine applicability of the use of early life exposure adjustments to identified carcinogens. For risk assessments conducted under the auspices of The Air Toxics "Hot Spots" Information and Assessment Act (AB 2588, Connelly, Statutes of 1987; Health and Safety Code Section 44300 et seq.) a weighting factor is applied to all carcinogens regardless of purported mechanism of action. However, for this assessment, the HRA relied upon U.S. Environmental Protection Agency guidance relating to the use of early life exposure adjustment factors (Supplemental Guidance for Assessing Susceptibility from Early-Life Exposure to Carcinogens, EPA/630/R-003F) whereby adjustment factors are only considered when carcinogens act "through the mutagenic mode of action." The U.S. Environmental Protection Agency has identified 19 compounds that elicit a mutagenic mode of action for

carcinogenesis. None of the gaseous compounds considered in the HRA elicit a mutagenic mode of action and, therefore, early life exposure adjustments were not considered. For diesel particulates, polycyclic aromatic hydrocarbons (PAHs) and their derivatives, which are known to exhibit a mutagenic mode of action, comprise < 1% of the exhaust particulate mass. To date, the U.S. Environmental Agency reports that whole diesel engine exhaust has not been shown to elicit a mutagenic mode of action.

To effectively quantify dose, the procedure requires the incorporation of several discrete exposure variates. Once determined, contaminant dose is multiplied by the cancer potency factor (CPF) in units of inverse dose expressed in milligrams per kilogram per day (mg/kg/day)<sup>-1</sup> to derive the cancer risk estimate. Therefore, to assess exposures associated with the proposed residential population, the following dose algorithm was utilized.

$$CDI = (C_{air} \times EF \times ED \times IR) / (BW \times AT)$$

Where:

- CDI = chronic daily intake (mg/kg/day)
- C<sub>air</sub> = concentration of contaminant in air (mg/m<sup>3</sup>)
- EF = exposure frequency (days/year)
- ED = exposure duration (years)
- IR = inhalation rate (m<sup>3</sup>/day)
- BW = body weight (kg)
- AT = averaging time (days)

To represent residential exposures, the assessment employed the U.S. Environmental Protection Agency's guidance to develop viable dose estimates based on reasonable maximum exposures (RME). Specifically, activity patterns for population mobility recommended by the U.S. Environmental Protection Agency and presented in the *Exposure Factors Handbook* were utilized. As a result, lifetime risk values for residents were adjusted to account for an exposure duration of 350 days per year for 30 years (i.e., 95<sup>th</sup> percentile). These values are consistent with the California Environmental Quality Act which considers the evaluation of environmental effects of proposed projects in a manner that reflects both reasonable and feasible assumptions.

## 5.2 NON-CARCINOGENIC EXPOSURES

An evaluation of the potential noncancerous effects of contaminant exposures was also conducted. Under the point estimate approach, adverse health effects are evaluated by comparing the concentration of each compound with the appropriate Reference Exposure Level (REL). Available REL's presented in the *Consolidated Table of OEHHA/ARB Approved Risk Assessment Health Values* were considered in the assessment.

To quantify noncarcinogenic impacts, the hazard index approach was used. The hazard index assumes that subthreshold exposures adversely affect a specific organ or organ system (i.e., toxicological endpoint). For each discrete pollutant exposure, target organs presented in regulatory guidance were utilized.

To calculate the hazard index, the pollutant concentration or dose is divided by the appropriate toxicity value. For compounds affecting the same toxicological endpoint, this ratio is summed. Where the total equals or exceeds one (i.e., unity), a health hazard is presumed to exist. For chronic exposures, REL's were converted to units expressed in mg/kg/day to accommodate the above referenced intake algorithm. To assess acute noncancer impacts, the maximum pollutant concentration is divided by the REL for the corresponding averaging time (e.g., 1-hour). No exposure adjustments are considered for short duration exposures.

Appendix 3.2, summarizes the REL's and corresponding reference dose values used in the evaluation of chronic noncarcinogenic and acute exposures. The noncancer hazard quotient for identified compounds generated from each source and a summation for each toxicological endpoint are presented on this table.

For chronic noncarcinogenic effects, the hazard index identified for each toxicological endpoint totaled less than the threshold of 1.0 for all exposure scenarios. For acute exposures, the hazard indices for the identified averaging times did not exceed the threshold of 1.0. Therefore, acute and chronic non-carcinogenic hazards were predicted to be within acceptable limits and are less than significant.

### **5.3 POTENTIAL CANCER AND NON-CANCER RISKS<sup>2</sup>**

For carcinogenic exposures resulting from exposure to toxics from the freeway, the summation of risk for the maximum exposed residential receptor totaled 3.58 in one million and will not exceed the SCAQMD significance threshold of 10 in one million.

---

2 SCAQMD guidance does not require assessment of the potential health risk to on-site workers. Excerpts from the document OEHHA Air Toxics Hot Spots Program Risk Assessment Guidelines—The Air Toxics Hot Spots Program Guidance Manual for Preparation of Health Risk Assessments (OEHHA 2003), also indicate that it is not necessary to examine the health effects to on-site workers unless required by RCRA (Resource Conservation and Recovery Act) / CERCLA (Comprehensive Environmental Response, Compensation, and Liability Act) or the worker resides on-site.

*This page intentionally left blank*



## 6 REFERENCES

1. **American Society of Heating, Refrigerating and Air-Conditioning Engineers, Inc.** *Method of Testing General Ventilation Air Cleaning Devices for Removal by Particle Size*. 2017. ANSI/ASHRAE Standard 52.2.2017.
2. **California Department of Transportation.** EMFAC Software. [Online]  
<http://www.dot.ca.gov/hq/env/air/pages/emfac.htm>.
3. **South Coast Air Quality Management District.** Mobile Source Toxics Analysis. [Online] 2003.  
[http://www.aqmd.gov/ceqa/handbook/mobile\\_toxic/mobile\\_toxic.html](http://www.aqmd.gov/ceqa/handbook/mobile_toxic/mobile_toxic.html).

*This page intentionally left blank*

## 7 CERTIFICATION

The contents of this HRA represent an accurate depiction of the potential impacts to the proposed Central Pointe Mixed-Use Development Project. The information contained in this HRA is based on the best available data at the time of preparation. If you have any questions, please contact me directly at (949) 336-5987.

Haseeb Qureshi  
Associate Principal  
URBAN CROSSROADS, INC.  
260 E Baker St.  
Costa Mesa, CA 92626  
(949) 336-5987  
[hqureshi@urbanxroads.com](mailto:hqureshi@urbanxroads.com)

### EDUCATION

Master of Science in Environmental Studies  
California State University, Fullerton • May 2010

Bachelor of Arts in Environmental Analysis and Design  
University of California, Irvine • June 2006

### PROFESSIONAL AFFILIATIONS

AEP – Association of Environmental Planners  
AWMA – Air and Waste Management Association  
ASTM – American Society for Testing and Materials

### PROFESSIONAL CERTIFICATIONS

Environmental Site Assessment – American Society for Testing and Materials • June 2013  
Planned Communities and Urban Infill – Urban Land Institute • June 2011  
Indoor Air Quality and Industrial Hygiene – EMSL Analytical • April 2008  
Principles of Ambient Air Monitoring – California Air Resources Board • August 2007  
AB2588 Regulatory Standards – Trinity Consultants • November 2006  
Air Dispersion Modeling – Lakes Environmental • June 2006

*This page intentionally left blank*

**APPENDIX 3.1:**  
**EMISSION RATE CALCULATION WORKSHEETS**

*This page intentionally left blank*

EMFAC2017  
Worksheet  
(65 mph)

EMFAC2017 Emission Rates  
Region Type: County  
Region: ORANGE  
Calendar Year: 2020  
Season: Annual  
Vehicle Classification: EMFAC2007 Categories  
Pollutant Classification: Criteria

Region	CalYr	Season	Veh_Class	Fuel	MdlYr	Speed (miles/hr)	Population (vehicles)	Wt Frac	CO_RUNEX (gms/mile)	CO_RUNEX AVE (gms/mile)	NOX_RUNEX (gms/mile)	NOx_RUNEX AVE (gms/mile)	PM10_RUNEX (gms/mile)	PM10_RUNEX AVE (gms/mile)	PM10_PMTW (gms/mile)	PM10_PMTW_AVE (gms/mile)	PM10_PMBW (gms/mile)	PM10_PMBW_AVE (gms/mile)
ORANGE	2020	Annual	LDA	DSL	Aggregated	65	11164.903	0.0048	0.1576780	0.00074923	0.0868281	0.00041257	0.0082320	0.00003912	0.0080	0.00003801	0.03675	0.000174622
ORANGE	2020	Annual	LDA	GAS	Aggregated	65	1247860.077	0.5311	0.5131502	0.27251912	0.0438778	0.02330222	0.0014267	0.00075769	0.0080	0.00424857	0.03675	0.019516854
ORANGE	2020	Annual	LDT1	DSL	Aggregated	65	55.819	0.0000	1.8674899	0.00004436	1.3902125	0.00003303	0.1898617	0.00000451	0.0080	0.00000019	0.03675	0.000000873
ORANGE	2020	Annual	LDT1	GAS	Aggregated	65	134019.271	0.0570	1.0208223	0.05822426	0.1234590	0.00704169	0.0020130	0.00011482	0.0080	0.00045629	0.03675	0.002096096
ORANGE	2020	Annual	LDT2	DSL	Aggregated	65	2427.176	0.0010	0.0729230	0.00007533	0.0357127	0.00003689	0.0045846	0.00000474	0.0080	0.00000826	0.03675	0.000037962
ORANGE	2020	Annual	LDT2	GAS	Aggregated	65	447357.582	0.1904	0.6886944	0.13111970	0.0859344	0.01636095	0.0013986	0.00026629	0.0080	0.00152311	0.03675	0.006996788
ORANGE	2020	Annual	LHDT1	DSL	Aggregated	65	21629.925	0.0092	0.5292682	0.00487211	2.2226139	0.02046000	0.0169925	0.00015642	0.0120	0.00011046	0.07644	0.000703659
ORANGE	2020	Annual	LHDT1	GAS	Aggregated	65	36819.260	0.0157	0.8630355	0.01352354	0.2146306	0.00336320	0.0010699	0.00001676	0.0080	0.00012536	0.07644	0.001197794
ORANGE	2020	Annual	LHDT2	DSL	Aggregated	65	8343.637	0.0036	0.4462804	0.00158471	1.8266933	0.00648646	0.0162931	0.00005786	0.0120	0.00004261	0.08918	0.000316672
ORANGE	2020	Annual	LHDT2	GAS	Aggregated	65	6427.420	0.0027	0.5119900	0.00140051	0.2149770	0.00058805	0.00009178	0.00000251	0.0080	0.00002188	0.08918	0.000243944
ORANGE	2020	Annual	MCY	GAS	Aggregated	65	55868.871	0.0238	23.7251412	0.56411192	1.2028594	0.02860035	0.0018872	0.00004487	0.0040	0.00009511	0.01176	0.000279617
ORANGE	2020	Annual	MDV	DSL	Aggregated	65	6028.952	0.0026	0.1265906	0.00032481	0.0591852	0.00015186	0.0048780	0.00001252	0.0080	0.00002053	0.03675	0.000094294
ORANGE	2020	Annual	MDV	GAS	Aggregated	65	312579.715	0.1330	0.9627388	0.12807249	0.1229682	0.01635837	0.0014811	0.00019704	0.0080	0.00106423	0.03675	0.004888827
ORANGE	2020	Annual	MH	DSL	Aggregated	65	2901.594	0.0012	0.2650886	0.00032735	3.6428042	0.00449841	0.1460253	0.00018032	0.0160	0.00001976	0.13034	0.000160954
ORANGE	2020	Annual	MH	GAS	Aggregated	65	7043.392	0.0030	2.2246649	0.00666857	0.4283714	0.00128407	0.0012950	0.00000388	0.0120	0.00003597	0.13034	0.000390702
ORANGE	2020	Annual	MHDT	DSL	Aggregated	65	27487.170	0.0117	0.3870657	0.00452795	2.5404975	0.0071908	0.0975440	0.00114108	0.0120	0.00014038	0.13034	0.001524735
ORANGE	2020	Annual	MHDT	GAS	Aggregated	65	7554.979	0.0032	0.9441306	0.00303565	0.3448827	0.00110890	0.00007712	0.00000248	0.0120	0.00003858	0.13034	0.000419081
ORANGE	2020	Annual	HHDT	DSL	Aggregated	65	10494.469	0.0045	0.3731136	0.00166643	4.0257130	0.01798001	0.0808631	0.00036116	0.0360	0.00016079	0.06174	0.000275749
ORANGE	2020	Annual	HHDT	GAS	Aggregated	65	10.178	0.0000	24.2851878	0.00010520	5.5044337	0.00002384	0.0012867	0.00000001	0.0200	0.00000009	0.06174	0.000000267
ORANGE	2020	Annual	OBUS	DSL	Aggregated	65	617.692	0.0003	0.5133360	0.00013495	3.8917273	0.000102306	0.1074946	0.00002826	0.0120	0.00000315	0.13034	0.000034264
ORANGE	2020	Annual	OBUS	GAS	Aggregated	65	995.682	0.0004	1.4501108	0.00061448	0.5132142	0.00021747	0.0007231	0.00000031	0.0120	0.00000508	0.13034	0.000055231
ORANGE	2020	Annual	SBUS	DSL	Aggregated	65	1330.412	0.0006	0.0000000	0.00000000	0.0000000	0.00000000	0.0000000	0.00000000	0.0120	0.00000679	0.74480	0.000421708
ORANGE	2020	Annual	SBUS	GAS	Aggregated	65	477.537	0.0002	0.0000000	0.00000000	0.0000000	0.00000000	0.0000000	0.00000000	0.0080	0.00000163	0.74480	0.000151368
ORANGE	2020	Annual	UBUS	DSL	Aggregated	65	0.000	0.0000	0.0000000	0.00000000	0.0000000	0.00000000	0.0000000	0.00000000	0.0000	0.00000000	0.0000	0.000000000
ORANGE	2020	Annual	UBUS	GAS	Aggregated	65	209.765	0.0001	0.2433834	0.00002173	0.3161702	0.00002823	0.0002009	0.00000002	0.0120	0.00000107	0.13035	0.000011637
							2349705	1.0		1.194	0.179	0.0034	0.008	0.040				

EMFAC2017 Emission Rates  
Region Type: County  
Region: ORANGE  
Calendar Year: 2020  
Season: Annual  
Vehicle Classification: EMFAC2007 Categories  
Pollutant Classification: TOG GAS

Region	CalYr	Season	Veh_Class	Fuel	MdlYr	Speed (miles/hr)	Population (vehicles)	Wt Frac	TOG_RUNEX (gms/mile)	TOG_RUNEX AVE (gms/mile)
ORANGE	2020	Annual	LDA	GAS	Aggregated	65	1247860.077	0.5528	0.0145697	0.0081
ORANGE	2020	Annual	LDT1	GAS	Aggregated	65	134019.271	0.0594	0.0364124	0.0022
ORANGE	2020	Annual	LDT2	GAS	Aggregated	65	447357.582	0.1982	0.0215635	0.0043
ORANGE	2020	Annual	LHDT1	GAS	Aggregated	65	36819.260	0.0163	0.0447649	0.0007
ORANGE	2020	Annual	LHDT2	GAS	Aggregated	65	6427.420	0.0028	0.0296607	0.0001
ORANGE	2020	Annual	MCY	GAS	Aggregated	65	55868.871	0.0248	2.7688096	0.0685
ORANGE	2020	Annual	MDV	GAS	Aggregated	65	312579.715	0.1385	0.0341850	0.0047
ORANGE	2020	Annual	MH	GAS	Aggregated	65	7043.392	0.0031	0.0913197	0.0003
ORANGE	2020	Annual	MHDT	GAS	Aggregated	65	7554.979	0.0033	0.0611843	0.0002
ORANGE	2020	Annual	HHDT	GAS	Aggregated	65	10.178	0.0000	0.9835975	0.0000
ORANGE	2020	Annual	OBUS	GAS	Aggregated	65	995.682	0.0004	0.0883973	0.0000
ORANGE	2020	Annual	SBUS	GAS	Aggregated	65	477.537	0.0002	0.0000000	0.0000
ORANGE	2020	Annual	UBUS	GAS	Aggregated	65	209.765	0.0001	0.0141811	0.0000
							2257224	1.0	0.089	

EMFAC2017  
Worksheet  
(65 mph)

PM2_5_RUNEX (gms/mile)	PM2_5_RUNEX_AVE (gms/mile)	PM2_5_PMTW (gms/mile)	PM2_5_PMTW_AVE (gms/mile)	PM2_5_PMBW (gms/mile)	PM2_5_PMBW_AVE (gms/mile)
0.0078759	0.000037423	0.0020	0.000009503	0.01575	0.000074838
0.0013119	0.000696685	0.0020	0.001062142	0.01575	0.008364366
0.1816483	0.000004315	0.0020	0.000000048	0.01575	0.000000374
0.0018511	0.000105579	0.0020	0.000114073	0.01575	0.000898327
0.0043863	0.000004531	0.0020	0.000002066	0.01575	0.000016269
0.0012861	0.000244850	0.0020	0.000380778	0.01575	0.002998623
0.0162574	0.000149655	0.0030	0.000027616	0.03276	0.000301568
0.0009842	0.000015422	0.0020	0.000031339	0.03276	0.000513340
0.0155883	0.000055353	0.0030	0.000010653	0.03822	0.000135716
0.0008438	0.000002308	0.0020	0.000005471	0.03822	0.000104548
0.0017678	0.000042032	0.0010	0.000023777	0.00504	0.000119836
0.0046670	0.000011975	0.0020	0.000005132	0.01575	0.000040412
0.0013630	0.000181322	0.0020	0.000266059	0.01575	0.002095212
0.1397083	0.000172522	0.0040	0.000004940	0.05586	0.000068980
0.0011917	0.000003572	0.0030	0.000008993	0.05586	0.000167444
0.0933243	0.001091720	0.0030	0.000035094	0.05586	0.000653458
0.0007091	0.000002280	0.0030	0.000009646	0.05586	0.000179606
0.0773650	0.000345535	0.0090	0.000040197	0.02646	0.000118178
0.0011830	0.000000005	0.0050	0.000000022	0.02646	0.000000115
0.1028444	0.000027036	0.0030	0.000000789	0.05586	0.000014684
0.0006651	0.000000282	0.0030	0.000001271	0.05586	0.000023671
0.0000000	0.000000000	0.0030	0.000001699	0.3192	0.000180732
0.0000000	0.000000000	0.0020	0.000000406	0.31920	0.000064872
0.0000000	0.000000000	0.0000	0.000000000	0.0000	0.000000000
0.0001847	0.000000016	0.0030	0.000000268	0.05587	0.000004987
0.0032		0.002		0.017	



EMFAC2017  
Worksheet  
(65 mph)

EMFAC2017 Emission Rates  
Region Type: County  
Region: Orange (SC)  
Calendar Year: 2020  
Season: Annual  
Vehicle Classification: EMFAC2007 Categories  
Pollutant Classification: TOG DSL

Region	CalYr	Season	Veh_Class	Fuel	MdlYr	Speed (miles/hr)	Population (vehicles)	Wt Frac	TOG_RUNEX (gms/mile)	TOG_RUNEX AVE (gms/mile)
ORANGE	2020	Annual	LDA	DSL	Aggregated	65	11164.903	0.1207	0.0140263	0.0017
ORANGE	2020	Annual	LDT1	DSL	Aggregated	65	55.819	0.0006	0.2697117	0.0002
ORANGE	2020	Annual	LDT2	DSL	Aggregated	65	2427.176	0.0262	0.0099900	0.0003
ORANGE	2020	Annual	LHDT1	DSL	Aggregated	65	21629.925	0.2339	0.0791822	0.0185
ORANGE	2020	Annual	LHDT2	DSL	Aggregated	65	8343.637	0.0902	0.0686702	0.0062
ORANGE	2020	Annual	MDV	DSL	Aggregated	65	6028.952	0.0652	0.0091178	0.0006
ORANGE	2020	Annual	MH	DSL	Aggregated	65	2901.594	0.0314	0.0638991	0.0020
ORANGE	2020	Annual	MHDT	DSL	Aggregated	65	27487.170	0.2972	0.1043012	0.0310
ORANGE	2020	Annual	HHDT	DSL	Aggregated	65	10494.469	0.1135	0.1028850	0.0117
ORANGE	2020	Annual	OBUS	DSL	Aggregated	65	617.692	0.0067	0.1618479	0.0011
ORANGE	2020	Annual	SBUS	DSL	Aggregated	65	1330.412	0.0144	0.0000000	0.0000
ORANGE	2020	Annual	UBUS	DSL	Aggregated	65	0.000	0.0000	0.0000000	0.0000
							92482	1.0		0.073

EMFAC2017 Emission Rates  
Region Type: County  
Region: Orange (SC)  
Calendar Year: 2020  
Season: Annual  
Vehicle Classification: EMFAC2007 Categories  
Pollutant Classification: DSL Particulate

Region	CalYr	Season	Veh_Class	Fuel	MdlYr	Speed (miles/hr)	Population (vehicles)	Wt Frac	PM10_RUNEX (gms/mile)	PM10_RUNEX AVE (gms/mile)
ORANGE	2020	Annual	LDA	DSL	Aggregated	65	11164.903	0.1207	0.0082320	0.0010
ORANGE	2020	Annual	LDT1	DSL	Aggregated	65	55.819	0.0006	0.1898617	0.0001
ORANGE	2020	Annual	LDT2	DSL	Aggregated	65	2427.176	0.0262	0.0045846	0.0001
ORANGE	2020	Annual	LHDT1	DSL	Aggregated	65	21629.925	0.2339	0.0169925	0.0040
ORANGE	2020	Annual	LHDT2	DSL	Aggregated	65	8343.637	0.0902	0.0162931	0.0015
ORANGE	2020	Annual	MDV	DSL	Aggregated	65	6028.952	0.0652	0.0048780	0.0003
ORANGE	2020	Annual	MH	DSL	Aggregated	65	2901.594	0.0314	0.1460253	0.0046
ORANGE	2020	Annual	MHDT	DSL	Aggregated	65	27487.170	0.2972	0.0975440	0.0290
ORANGE	2020	Annual	HHDT	DSL	Aggregated	65	10494.469	0.1135	0.0808631	0.0092
ORANGE	2020	Annual	OBUS	DSL	Aggregated	65	617.692	0.0067	0.1074946	0.0007
ORANGE	2020	Annual	SBUS	DSL	Aggregated	65	1330.412	0.0144	0.0000000	0.0000
ORANGE	2020	Annual	UBUS	DSL	Aggregated	65	0.000	0.0000	0.0000000	0.0000
							92482	1.0		0.050

On-Road Mobile Sources  
Emission Rate Computation

**Interstate 5 Mainline**

**DSL Particulate Emissions**

Number of Sources	9
Link Length (meters)	520
Volume/Baseline (VPH)	540
Pollutant Mass Emission Rate (gr/mi)	0.050

$$Emission\ Rate\ (gr/sec) = ((Mass\ Emission\ Rate\ x\ Volume/Baseline)/(1609.3\ m/mile) \times (3600\ sec/hr)) \times L$$

Pollutant Emission Rate (gr/sec)	0.00242	
Pollutant Emission Rate (gr/sec/source)	<table border="1"><tr><td>2.69E-04</td></tr></table>	2.69E-04
2.69E-04		

All	2349705
DSL	92482

Diesel Fleet Mix (weight fraction)

0.0394

Link Counts		AADT	VPH all	VPH gas	VPH diesel
1	Interstate 5 Mainline	329500	13729	13189	540
6	I-5 SB On-Ramp at 1st St.	14900	621	596	24

**APPENDIX 3.2:**  
**RISK CALCULATION WORKSHEETS**

*This page intentionally left blank*

**Table A1**  
**Quantification of Carcinogenic Risks and Noncarcinogenic Hazards**  
**30 Year Exposure Scenario / Maximum Residential Receptor**

Source (a)	Concentration		Weight Fraction (d)	Contaminant (e)	Carcinogenic Risk			Noncarcinogenic Hazards / Toxicological Endpoints*									
	(ug/m3) (b)	(mg/m3) (c)			URF (ug/m3) (f)	CPF (mg/kg/day) (g)	RISK (h)	REL (ug/m3) (i)	RfD (mg/kg/day) (j)	RESP (k)	CNS/PNS (l)	CV/BL (m)	IMMUN (n)	KIDN (o)	GI/LV (p)	REPRO (q)	EYES (r)
	Freeway	0.02900			2.9E-05	1.00E+00	Diesel Particulates	3.0E-04	1.1E+00	3.6E-06	5.0E+00	1.4E-03	5.6E-03				
<b>Total</b>					3.58E-06			5.6E-03    0.0E+00    0.0E+00    0.0E+00    0.0E+00    0.0E+00    0.0E+00    0.0E+00    0.0E+00									

\* Key to Toxicological Endpoints

RESP            Respiratory System  
CNS/PNS        Central/Peripheral Nervous System  
CV/BL           Cardiovascular/Blood System  
IMMUN          Immune System  
KIDN            Kidney  
GI/LV            Gastrointestinal System/Liver  
REPRO          Reproductive System (e.g., teratogenic and developmental effects)  
EYES            Eye irritation and/or other effects

Note:            Exposure factors used to calculate contaminant intake

exposure frequency (days/year)	350
exposure duration (years)	30
inhalation rate (m3/day)	20
average body weight (kg)	70
averaging time <sub>(cancer)</sub> (days)	25550
averaging time <sub>(noncancer)</sub> (days)	10950

**APPENDIX 4.1:**  
**AERMOD MODEL OUTPUT SUMMARY FILE**

*This page intentionally left blank*



▲ \*\*\* AERMOD - VERSION 19191 \*\*\* \*\*\* C:\LAKES\AERMOD VIEW\1660 E FIRST ST\1660  
E FIRST ST.ISC \*\*\* 06/05/20  
\*\*\* AERMET - VERSION 16216 \*\*\* \*\*\*  
\*\*\* 02:17:27

PAGE 1  
\*\*\* MODELOPTs: RegDEFAULT CONC ELEV FLGPOL URBAN ADJ\_U\*

\*\*\* MODEL SETUP OPTIONS SUMMARY

\*\*\*

-----  
-----

\*\*Model Is Setup For Calculation of Average CONCentration Values.

-- DEPOSITION LOGIC --

\*\*NO GAS DEPOSITION Data Provided.

\*\*NO PARTICLE DEPOSITION Data Provided.

\*\*Model Uses NO DRY DEPLETION. DRYDPLT = F

\*\*Model Uses NO WET DEPLETION. WETDPLT = F

\*\*Model Uses URBAN Dispersion Algorithm for the SBL for 9 Source(s),  
for Total of 1 Urban Area(s):

Urban Population = 3010232.0 ; Urban Roughness Length = 1.000 m

\*\*Model Uses Regulatory DEFAULT Options:

1. Stack-tip Downwash.
2. Model Accounts for ELEVated Terrain Effects.
3. Use Calms Processing Routine.
4. Use Missing Data Processing Routine.
5. No Exponential Decay.
6. Urban Roughness Length of 1.0 Meter Assumed.

\*\*Other Options Specified:

ADJ\_U\* - Use ADJ\_U\* option for SBL in AERMET

CCVR\_Sub - Meteorological data includes CCVR substitutions

TEMP\_Sub - Meteorological data includes TEMP substitutions

\*\*Model Accepts FLAGPOLE Receptor Heights.

\*\*The User Specified a Pollutant Type of: DPM

\*\*Model Calculates ANNUAL Averages Only

\*\*This Run Includes: 9 Source(s); 1 Source Group(s); and 348  
Receptor(s)

with: 0 POINT(s), including  
0 POINTCAP(s) and 0 POINTHOR(s)

and: 9 VOLUME source(s)

and: 0 AREA type source(s)  
and: 0 LINE source(s)  
and: 0 RLINE/RLINEXT source(s)  
and: 0 OPENPIT source(s)  
and: 0 BUOYANT LINE source(s) with 0 line(s)

\*\*Model Set To Continue RUNNING After the Setup Testing.

\*\*The AERMET Input Meteorological Data Version Date: 16216

\*\*Output Options Selected:

Model Outputs Tables of ANNUAL Averages by Receptor  
Model Outputs External File(s) of High Values for Plotting (PLOTFILE

Keyword)

Model Outputs Separate Summary File of High Ranked Values (SUMMFILE

Keyword)

\*\*NOTE: The Following Flags May Appear Following CONC Values: c for Calm Hours  
m for Missing

Hours

b for Both Calm

and Missing Hours

\*\*Misc. Inputs: Base Elev. for Pot. Temp. Profile (m MSL) = 17.00 ; Decay  
Coef. = 0.000 ; Rot. Angle = 0.0  
Emission Units = GRAMS/SEC ;  
Emission Rate Unit Factor = 0.10000E+07  
Output Units = MICROGRAMS/M\*\*3

\*\*Approximate Storage Requirements of Model = 3.5 MB of RAM.

\*\*Input Runstream File: aermod.inp

\*\*Output Print File: aermod.out

\*\*Detailed Error/Message File: 13400 FREEWAY HRA.ERR

\*\*File for Summary of Results: 13400 FREEWAY HRA.SUM

▲ \*\*\* AERMOD - VERSION 19191 \*\*\* \*\*\* C:\LAKES\AERMOD VIEW\1660 E FIRST ST\1660  
E FIRST ST.ISC \*\*\* 06/05/20  
\*\*\* AERMET - VERSION 16216 \*\*\* \*\*\*  
\*\*\* 02:17:27

PAGE 2

\*\*\* MODELOPTs: RegDEFAULT CONC ELEV FLGPOL URBAN ADJ\_U\*

\*\*\* METEOROLOGICAL DAYS SELECTED FOR



Name: UNKNOWN

Name: UNKNOWN

Year: 2012

Year: 2012

First 24 hours of scalar data

YR	MO	DY	JDY	HR	H0	U*	W*	DT/DZ	ZICNV	ZIMCH	M-O	LEN	Z0	BOWEN
ALBEDO	REF	WS	WD	HT	REF	TA	HT							

12	01	01	1	01	-4.5	0.082	-9.000	-9.000	-999.	56.	11.0	0.12	2.65
1.00	0.87	62.			5.8	283.8	2.0						
12	01	01	1	02	-3.5	0.073	-9.000	-9.000	-999.	47.	9.9	0.12	2.65
1.00	0.77	27.			5.8	283.1	2.0						
12	01	01	1	03	-3.5	0.073	-9.000	-9.000	-999.	47.	9.9	0.12	2.65
1.00	0.77	336.			5.8	283.1	2.0						
12	01	01	1	04	-3.3	0.070	-9.000	-9.000	-999.	45.	9.7	0.12	2.65
1.00	0.74	34.			5.8	283.1	2.0						
12	01	01	1	05	-3.0	0.068	-9.000	-9.000	-999.	42.	9.4	0.12	2.65
1.00	0.70	154.			5.8	282.5	2.0						
12	01	01	1	06	-999.0	-9.000	-9.000	-9.000	-999.	-999.	-99999.0	0.12	2.65
1.00	0.00	0.			5.8	282.0	2.0						
12	01	01	1	07	-2.0	0.059	-9.000	-9.000	-999.	34.	9.0	0.12	2.65
1.00	0.55	343.			5.8	281.4	2.0						
12	01	01	1	08	-2.6	0.066	-9.000	-9.000	-999.	40.	9.7	0.12	2.65
0.53	0.69	25.			5.8	281.4	2.0						
12	01	01	1	09	21.6	0.133	0.252	0.010	27.	116.	-9.9	0.12	2.65
0.31	1.03	344.			5.8	282.5	2.0						
12	01	01	1	10	115.6	0.162	0.713	0.008	114.	156.	-3.3	0.12	2.65
0.24	1.06	233.			5.8	286.4	2.0						
12	01	01	1	11	160.9	0.126	1.129	0.005	325.	108.	-1.1	0.12	2.65
0.21	0.67	261.			5.8	291.4	2.0						
12	01	01	1	12	187.0	0.138	1.467	0.005	614.	123.	-1.3	0.12	2.65
0.20	0.75	252.			5.8	294.9	2.0						
12	01	01	1	13	186.9	0.189	1.755	0.005	1051.	197.	-3.3	0.12	2.65
0.20	1.23	280.			5.8	297.5	2.0						
12	01	01	1	14	168.3	0.247	1.857	0.005	1383.	295.	-8.1	0.12	2.65
0.21	1.86	268.			5.8	299.2	2.0						
12	01	01	1	15	115.3	0.275	1.688	0.005	1517.	346.	-16.3	0.12	2.65
0.24	2.25	248.			5.8	298.1	2.0						
12	01	01	1	16	41.5	0.262	1.211	0.005	1552.	322.	-39.2	0.12	2.65
0.33	2.32	227.			5.8	295.9	2.0						
12	01	01	1	17	-17.9	0.217	-9.000	-9.000	-999.	244.	52.0	0.12	2.65
0.60	2.18	227.			5.8	292.5	2.0						
12	01	01	1	18	-24.7	0.250	-9.000	-9.000	-999.	300.	68.7	0.12	2.65
1.00	2.50	219.			5.8	288.8	2.0						
12	01	01	1	19	-5.2	0.088	-9.000	-9.000	-999.	91.	12.0	0.12	2.65
1.00	0.94	201.			5.8	287.5	2.0						
12	01	01	1	20	-3.5	0.073	-9.000	-9.000	-999.	47.	10.0	0.12	2.65
1.00	0.77	259.			5.8	287.0	2.0						
12	01	01	1	21	-2.6	0.064	-9.000	-9.000	-999.	39.	9.1	0.12	2.65

```

1.00  0.65  264.  5.8  286.4  2.0
  12 01 01  1 22  -4.4  0.081 -9.000 -9.000 -999.  55.  10.9  0.12  2.65
1.00  0.86  211.  5.8  285.9  2.0
  12 01 01  1 23  -4.2  0.079 -9.000 -9.000 -999.  53.  10.7  0.12  2.65
1.00  0.84  247.  5.8  284.9  2.0
  12 01 01  1 24  -7.1  0.103 -9.000 -9.000 -999.  80.  14.1  0.12  2.65
1.00  1.09  236.  5.8  283.8  2.0

```

First hour of profile data

```

YR MO DY HR HEIGHT F  WDIR      WSPD AMB_TMP sigmaA  sigmaW  sigmaV
12 01 01 01    5.8 1   62.    0.87  283.8  99.0  -99.00 -99.00

```

F indicates top of profile (=1) or below (=0)

```

^ *** AERMOD - VERSION 19191 ***      *** C:\LAKES\AERMOD VIEW\1660 E FIRST ST\1660
E FIRST ST.ISC          ***          06/05/20
*** AERMET - VERSION 16216 ***      ***
***                                02:17:27

```

PAGE 4

```

*** MODELOPTs:   RegDFault  CONC  ELEV  FLGPOL  URBAN  ADJ_U*

```

\*\*\* THE SUMMARY OF MAXIMUM ANNUAL RESULTS

AVERAGED OVER 5 YEARS \*\*\*

\*\* CONC OF DPM IN MICROGRAMS/M\*\*3

\*\*

```

NETWORK
GROUP ID          AVERAGE CONC          RECEPTOR (XR, YR,
ZELEV, ZHILL, ZFLAG) OF TYPE GRID-ID

```

```

-----
ALL      1ST HIGHEST VALUE IS      0.11599 AT ( 421925.73, 3734653.54,
36.00,   36.00,   7.00) DC
          2ND HIGHEST VALUE IS      0.11329 AT ( 421937.11, 3734627.53,
36.00,   36.00,   7.00) DC
          3RD HIGHEST VALUE IS      0.11286 AT ( 421925.73, 3734662.21,
36.00,   36.00,   7.00) DC
          4TH HIGHEST VALUE IS      0.11236 AT ( 421902.97, 3734705.56,
36.45,   36.45,   7.00) DC
          5TH HIGHEST VALUE IS      0.11117 AT ( 421914.35, 3734688.22,
36.26,   36.26,   7.00) DC
          6TH HIGHEST VALUE IS      0.11073 AT ( 421937.11, 3734636.20,
36.00,   36.00,   7.00) DC
          7TH HIGHEST VALUE IS      0.10963 AT ( 421948.49, 3734601.52,
36.00,   36.00,   7.00) DC

```

36.08, 8TH HIGHEST VALUE IS 0.10923 AT ( 421925.73, 3734670.88,  
 36.08, 36.08, 7.00) DC  
 36.00, 9TH HIGHEST VALUE IS 0.10818 AT ( 421937.11, 3734644.87,  
 36.00, 36.00, 7.00) DC  
 36.54, 10TH HIGHEST VALUE IS 0.10817 AT ( 421902.97, 3734714.23,  
 36.54, 36.54, 7.00) DC

\*\*\* RECEPTOR TYPES: GC = GRIDCART  
 GP = GRIDPOLR  
 DC = DISCCART  
 DP = DISCPOLR

^ \*\*\* AERMOD - VERSION 19191 \*\*\* \*\*\* C:\LAKES\AERMOD VIEW\1660 E FIRST ST\1660  
 E FIRST ST.ISC \*\*\* 06/05/20  
 \*\*\* AERMET - VERSION 16216 \*\*\* \*\*\*  
 \*\*\* 02:17:27

PAGE 5

\*\*\* MODELOPTs: RegDFault CONC ELEV FLGPOL URBAN ADJ\_U\*

\*\*\* Message Summary : AERMOD Model Execution \*\*\*

----- Summary of Total Messages -----

A Total of 0 Fatal Error Message(s)  
 A Total of 2 Warning Message(s)  
 A Total of 1864 Informational Message(s)  
  
 A Total of 43848 Hours Were Processed  
  
 A Total of 1500 Calm Hours Identified  
  
 A Total of 364 Missing Hours Identified ( 0.83 Percent)

\*\*\*\*\* FATAL ERROR MESSAGES \*\*\*\*\*  
 \*\*\* NONE \*\*\*

\*\*\*\*\* WARNING MESSAGES \*\*\*\*\*  
 ME W186 99 MEOPEN: THRESH\_1MIN 1-min ASOS wind speed threshold used  
 0.50  
 ME W187 99 MEOPEN: ADJ\_U\* Option for Stable Low Winds used in AERMET

**APPENDIX 4.2:**

**AERMOD MODEL INPUT/OUTPUT FILES  
(ELECTRONIC FORMAT, AVAILABLE ON REQUEST)**

```

** Lakes Environmental AERMOD MPI
**
*****
**
** AERMOD INPUT PRODUCED BY:
** AERMOD VIEW VER. 9.9.0
** LAKES ENVIRONMENTAL SOFTWARE INC.
** DATE: 6/5/2020
** FILE: C:\LAKES\AERMOD VIEW\13400 FREEWAY HRA\13400 FREEWAY HRA.ADI
**

```

```

*****
**
**
*****

```

```

** AERMOD CONTROL PATHWAY
*****
**
**

```

```

CO STARTING
  TITLEONE C:\LAKES\AERMOD VIEW\1660 E FIRST ST\1660 E FIRST ST.ISC
  MODELOPT DFAULT CONC
  AVERTIME ANNUAL
  URBANOPT 3010232
  POLLUTID DPM
  FLAGPOLE 0.00
  RUNORNOT RUN
  ERRORFIL "13400 FREEWAY HRA.ERR"

```

```

CO FINISHED
**
*****

```

```

** AERMOD SOURCE PATHWAY
*****
**
**

```

```

SO STARTING
** SOURCE LOCATION **
** SOURCE ID - TYPE - X COORD. - Y COORD. **
** -----

```

```

** LINE SOURCE REPRESENTED BY ADJACENT VOLUME SOURCES
** LINE VOLUME SOURCE ID = SLINE1
** DESCRSRC I-5 MAINLINE
** PREFIX
** LENGTH OF SIDE = 57.91
** CONFIGURATION = ADJACENT
** EMISSION RATE = 0.00242
** VERTICAL DIMENSION = 7.59
** SZINIT = 3.53
** NODES = 4
** 421732.353, 3734852.628, 37.00, 0.00, 26.93
** 421856.672, 3734643.962, 36.00, 0.00, 26.93

```



```

** 421905.810, 3734500.098, 35.00, 0.00, 26.93
** 421939.898, 3734380.185, 34.94, 0.00, 26.93
** -----
LOCATION L0000001      VOLUME  421747.173 3734827.753 37.00
LOCATION L0000002      VOLUME  421776.813 3734778.004 37.00
LOCATION L0000003      VOLUME  421806.453 3734728.254 36.69
LOCATION L0000004      VOLUME  421836.093 3734678.504 36.15
LOCATION L0000005      VOLUME  421862.394 3734627.210 36.00
LOCATION L0000006      VOLUME  421881.112 3734572.408 36.00
LOCATION L0000007      VOLUME  421899.829 3734517.607 35.42
LOCATION L0000008      VOLUME  421916.585 3734462.192 35.00
LOCATION L0000009      VOLUME  421932.421 3734406.489 35.00

```

\*\* END OF LINE VOLUME SOURCE ID = SLINE1

\*\* SOURCE PARAMETERS \*\*

\*\* LINE VOLUME SOURCE ID = SLINE1

SRCPARAM L0000001	0.0002688889	0.00	26.93	3.53
SRCPARAM L0000002	0.0002688889	0.00	26.93	3.53
SRCPARAM L0000003	0.0002688889	0.00	26.93	3.53
SRCPARAM L0000004	0.0002688889	0.00	26.93	3.53
SRCPARAM L0000005	0.0002688889	0.00	26.93	3.53
SRCPARAM L0000006	0.0002688889	0.00	26.93	3.53
SRCPARAM L0000007	0.0002688889	0.00	26.93	3.53
SRCPARAM L0000008	0.0002688889	0.00	26.93	3.53
SRCPARAM L0000009	0.0002688889	0.00	26.93	3.53

```

** -----
URBANSRC ALL
SRCGROUP ALL

```

SO FINISHED

\*\*

\*\*\*\*\*

\*\* AERMOD RECEPTOR PATHWAY

\*\*\*\*\*

\*\*

\*\*

RE STARTING

INCLUDED "13400 FREEWAY HRA.ROU"

RE FINISHED

\*\*

\*\*\*\*\*

\*\* AERMOD METEOROLOGY PATHWAY

\*\*\*\*\*

\*\*

\*\*

ME STARTING

SURFFILE KSNA\_V9\_ADJU\KSNA\_V9.SFC

PROFFILE KSNA\_V9\_ADJU\KSNA\_V9.PFL

SURFDATA 93184 2012

UAIRDATA 3190 2012

PROFBASE 17.0 METERS

ME FINISHED

```

**
*****
** AERMOD OUTPUT PATHWAY
*****
**
**
OU STARTING
** AUTO-GENERATED PLOTFILES
  PLOTFILE ANNUAL ALL "13400 FREEWAY HRA.AD\AN00GALL.PLT" 31
  SUMMFILE "13400 FREEWAY HRA.SUM"
OU FINISHED

```

\*\*\* Message Summary For AERMOD Model Setup \*\*\*

----- Summary of Total Messages -----

```

A Total of          0 Fatal Error Message(s)
A Total of          2 Warning Message(s)
A Total of          0 Informational Message(s)

```

```

***** FATAL ERROR MESSAGES *****
      *** NONE ***

```

```

***** WARNING MESSAGES *****
ME W186      99      MEOPEN: THRESH_1MIN 1-min ASOS wind speed threshold used
      0.50
ME W187      99      MEOPEN: ADJ_U* Option for Stable Low Winds used in AERMET

```

```

*****
*** SETUP Finishes Successfully ***
*****

```

```

^ *** AERMOD - VERSION 19191 ***      *** C:\LAKES\AERMOD VIEW\1660 E FIRST ST\1660
E FIRST ST.ISC          ***          06/05/20
*** AERMET - VERSION 16216 ***      ***
      ***          02:17:27

```

```

                                PAGE 1
*** MODELOPTs:   RegDFault  CONC  ELEV  FLGPOL  URBAN  ADJ_U*

```

\*\*\* MODEL SETUP OPTIONS SUMMARY

\*\*\*

-----  
 -----  
 \*\*Model Is Setup For Calculation of Average CONCentration Values.

```

-- DEPOSITION LOGIC --
**NO GAS DEPOSITION Data Provided.
**NO PARTICLE DEPOSITION Data Provided.
**Model Uses NO DRY DEPLETION.  DRYDPLT = F
**Model Uses NO WET DEPLETION.  WETDPLT = F

**Model Uses URBAN Dispersion Algorithm for the SBL for      9 Source(s),
  for Total of      1 Urban Area(s):
  Urban Population =  3010232.0 ; Urban Roughness Length =  1.000 m

**Model Uses Regulatory DEFAULT Options:
  1. Stack-tip Downwash.
  2. Model Accounts for ELEVated Terrain Effects.
  3. Use Calms Processing Routine.
  4. Use Missing Data Processing Routine.
  5. No Exponential Decay.
  6. Urban Roughness Length of 1.0 Meter Assumed.

**Other Options Specified:
  ADJ_U*   - Use ADJ_U* option for SBL in AERMET
  CCVR_Sub - Meteorological data includes CCVR substitutions
  TEMP_Sub - Meteorological data includes TEMP substitutions

**Model Accepts FLAGPOLE Receptor Heights.

**The User Specified a Pollutant Type of:  DPM

**Model Calculates ANNUAL Averages Only

**This Run Includes:      9 Source(s);      1 Source Group(s); and      348
Receptor(s)

      with:      0 POINT(s), including
                  0 POINTCAP(s) and      0 POINTHOR(s)
      and:      9 VOLUME source(s)
      and:      0 AREA type source(s)
      and:      0 LINE source(s)
      and:      0 RLINE/RLINEXT source(s)
      and:      0 OPENPIT source(s)
      and:      0 BUOYANT LINE source(s) with      0 line(s)

**Model Set To Continue RUNNING After the Setup Testing.

**The AERMET Input Meteorological Data Version Date:  16216

**Output Options Selected:
  Model Outputs Tables of ANNUAL Averages by Receptor
  Model Outputs External File(s) of High Values for Plotting (PLOTFILE

```

Keyword)

Model Outputs Separate Summary File of High Ranked Values (SUMMFILE

Keyword)

\*\*NOTE: The Following Flags May Appear Following CONC Values: c for Calm Hours  
m for Missing

Hours

b for Both Calm

and Missing Hours

\*\*Misc. Inputs: Base Elev. for Pot. Temp. Profile (m MSL) = 17.00 ; Decay  
Coef. = 0.000 ; Rot. Angle = 0.0  
Emission Units = GRAMS/SEC ;  
Emission Rate Unit Factor = 0.10000E+07  
Output Units = MICROGRAMS/M\*\*3

\*\*Approximate Storage Requirements of Model = 3.5 MB of RAM.

\*\*Input Runstream File: aermod.inp

\*\*Output Print File: aermod.out

\*\*Detailed Error/Message File: 13400 FREEWAY HRA.ERR

\*\*File for Summary of Results: 13400 FREEWAY HRA.SUM

▲ \*\*\* AERMOD - VERSION 19191 \*\*\* \*\*\* C:\LAKES\AERMOD VIEW\1660 E FIRST ST\1660  
E FIRST ST.ISC \*\*\* 06/05/20  
\*\*\* AERMET - VERSION 16216 \*\*\* \*\*\*  
\*\*\* 02:17:27

PAGE 2

\*\*\* MODELOPTs: RegDFault CONC ELEV FLGPOL URBAN ADJ\_U\*

\*\*\* VOLUME SOURCE DATA \*\*\*

INIT.	URBAN	NUMBER	EMISSION	RATE		BASE	RELEASE	INIT.	
SOURCE		EMISSION	RATE		X	Y	ELEV.	HEIGHT	SY
SZ	SOURCE	SCALAR	VARY		(METERS)	(METERS)	(METERS)	(METERS)	(METERS)
ID		CATS.		BY					

L0000001		0	0.26889E-03		421747.2	3734827.8	37.0	0.00	26.93
3.53	YES								
L0000002		0	0.26889E-03		421776.8	3734778.0	37.0	0.00	26.93



3010232. L0000001 , L0000002 , L0000003 , L0000004 ,  
L0000005 , L0000006 , L0000007 ,  
L0000008 ,

L0000009 ,  
▲ \*\*\* AERMOD - VERSION 19191 \*\*\* \*\*\* C:\LAKES\AERMOD VIEW\1660 E FIRST ST\1660  
E FIRST ST.ISC \*\*\* 06/05/20  
\*\*\* AERMET - VERSION 16216 \*\*\* \*\*\*  
\*\*\* 02:17:27

PAGE 5

\*\*\* MODELOPTs: RegDEFAULT CONC ELEV FLGPOL URBAN ADJ\_U\*

\*\*\* DISCRETE CARTESIAN RECEPTORS \*\*\*  
(X-COORD, Y-COORD, ZELEV, ZHILL, ZFLAG)  
(METERS)

( 421959.9, 3734566.8, 35.9, 35.9, 7.0);	( 421971.2, 3734566.8, 36.0, 36.0, 7.0);
( 421982.6, 3734566.8, 36.0, 36.0, 7.0);	( 421994.0, 3734566.8, 36.0, 36.0, 7.0);
( 422005.4, 3734566.8, 36.0, 36.0, 7.0);	( 422016.8, 3734566.8, 36.0, 36.0, 7.0);
( 422028.1, 3734566.8, 36.0, 36.0, 7.0);	( 422039.5, 3734566.8, 36.0, 36.0, 7.0);
( 422050.9, 3734566.8, 36.0, 36.0, 7.0);	( 422062.3, 3734566.8, 36.0, 36.0, 7.0);
( 422073.7, 3734566.8, 36.0, 36.0, 7.0);	( 422085.0, 3734566.8, 36.0, 36.0, 7.0);
( 422096.4, 3734566.8, 36.0, 36.0, 7.0);	( 422107.8, 3734566.8, 36.0, 36.0, 7.0);
( 422119.2, 3734566.8, 36.0, 36.0, 7.0);	( 422130.6, 3734566.8, 36.0, 36.0, 7.0);
( 421959.9, 3734575.5, 36.0, 36.0, 7.0);	( 421971.2, 3734575.5, 36.0, 36.0, 7.0);
( 421982.6, 3734575.5, 36.0, 36.0, 7.0);	( 421994.0, 3734575.5, 36.0, 36.0, 7.0);
( 422005.4, 3734575.5, 36.0, 36.0, 7.0);	( 422016.8, 3734575.5, 36.0, 36.0, 7.0);
( 422028.1, 3734575.5, 36.0, 36.0, 7.0);	( 422039.5, 3734575.5, 36.0, 36.0, 7.0);
( 422050.9, 3734575.5, 36.0, 36.0, 7.0);	( 422062.3, 3734575.5, 36.0, 36.0, 7.0);
( 422073.7, 3734575.5, 36.0, 36.0, 7.0);	( 422085.0, 3734575.5, 36.0, 36.0, 7.0);
( 422096.4, 3734575.5, 36.0, 36.0, 7.0);	( 422107.8, 3734575.5, 36.0, 36.0, 7.0);
( 422119.2, 3734575.5, 36.0, 36.0, 7.0);	( 422130.6, 3734575.5, 36.0, 36.0, 7.0);

( 421959.9, 3734584.2, 36.0, 36.0, 7.0); ( 421971.2,  
 3734584.2, 36.0, 36.0, 7.0);  
 ( 421982.6, 3734584.2, 36.0, 36.0, 7.0); ( 421994.0,  
 3734584.2, 36.0, 36.0, 7.0);  
 ( 422005.4, 3734584.2, 36.0, 36.0, 7.0); ( 422016.8,  
 3734584.2, 36.0, 36.0, 7.0);  
 ( 422028.1, 3734584.2, 36.0, 36.0, 7.0); ( 422039.5,  
 3734584.2, 36.0, 36.0, 7.0);  
 ( 422050.9, 3734584.2, 36.0, 36.0, 7.0); ( 422062.3,  
 3734584.2, 36.0, 36.0, 7.0);  
 ( 422073.7, 3734584.2, 36.0, 36.0, 7.0); ( 422085.0,  
 3734584.2, 36.0, 36.0, 7.0);  
 ( 422096.4, 3734584.2, 36.0, 36.0, 7.0); ( 422107.8,  
 3734584.2, 36.0, 36.0, 7.0);  
 ( 422119.2, 3734584.2, 36.0, 36.0, 7.0); ( 422130.6,  
 3734584.2, 36.0, 36.0, 7.0);  
 ( 421959.9, 3734592.8, 36.0, 36.0, 7.0); ( 421971.2,  
 3734592.8, 36.0, 36.0, 7.0);  
 ( 421982.6, 3734592.8, 36.0, 36.0, 7.0); ( 421994.0,  
 3734592.8, 36.0, 36.0, 7.0);  
 ( 422005.4, 3734592.8, 36.0, 36.0, 7.0); ( 422016.8,  
 3734592.8, 36.0, 36.0, 7.0);  
 ( 422028.1, 3734592.8, 36.0, 36.0, 7.0); ( 422039.5,  
 3734592.8, 36.0, 36.0, 7.0);  
 ( 422050.9, 3734592.8, 36.0, 36.0, 7.0); ( 422062.3,  
 3734592.8, 36.0, 36.0, 7.0);  
 ( 422073.7, 3734592.8, 36.0, 36.0, 7.0); ( 422085.0,  
 3734592.8, 36.0, 36.0, 7.0);  
 ( 422096.4, 3734592.8, 36.0, 36.0, 7.0); ( 422107.8,  
 3734592.8, 36.0, 36.0, 7.0);  
 ( 422119.2, 3734592.8, 36.0, 36.0, 7.0); ( 422130.6,  
 3734592.8, 36.0, 36.0, 7.0);  
 ( 421948.5, 3734601.5, 36.0, 36.0, 7.0); ( 421959.9,  
 3734601.5, 36.0, 36.0, 7.0);  
 ( 421971.2, 3734601.5, 36.0, 36.0, 7.0); ( 421982.6,  
 3734601.5, 36.0, 36.0, 7.0);  
 ( 421994.0, 3734601.5, 36.0, 36.0, 7.0); ( 422005.4,  
 3734601.5, 36.0, 36.0, 7.0);  
 ( 422016.8, 3734601.5, 36.0, 36.0, 7.0); ( 422028.1,  
 3734601.5, 36.0, 36.0, 7.0);  
 ( 422039.5, 3734601.5, 36.0, 36.0, 7.0); ( 422050.9,  
 3734601.5, 36.0, 36.0, 7.0);  
 ( 422062.3, 3734601.5, 36.0, 36.0, 7.0); ( 422073.7,  
 3734601.5, 36.0, 36.0, 7.0);  
 ( 422085.0, 3734601.5, 36.0, 36.0, 7.0); ( 422096.4,  
 3734601.5, 36.0, 36.0, 7.0);  
 ( 422107.8, 3734601.5, 36.0, 36.0, 7.0); ( 422119.2,  
 3734601.5, 36.0, 36.0, 7.0);  
 ( 422130.6, 3734601.5, 36.0, 36.0, 7.0); ( 421948.5,  
 3734610.2, 36.0, 36.0, 7.0);

```

( 421959.9, 3734610.2, 36.0, 36.0, 7.0); ( 421971.2,
3734610.2, 36.0, 36.0, 7.0);
( 421982.6, 3734610.2, 36.0, 36.0, 7.0); ( 421994.0,
3734610.2, 36.0, 36.0, 7.0);
( 422005.4, 3734610.2, 36.0, 36.0, 7.0); ( 422016.8,
3734610.2, 36.0, 36.0, 7.0);
( 422028.1, 3734610.2, 36.0, 36.0, 7.0); ( 422039.5,
3734610.2, 36.0, 36.0, 7.0);
^ *** AERMOD - VERSION 19191 *** *** C:\LAKES\AERMOD VIEW\1660 E FIRST ST\1660
E FIRST ST.ISC *** 06/05/20
*** AERMET - VERSION 16216 *** ***
*** 02:17:27

```

PAGE 6

\*\*\* MODELOPTs: RegDFault CONC ELEV FLGPOL URBAN ADJ\_U\*

\*\*\* DISCRETE CARTESIAN RECEPTORS \*\*\*  
(X-COORD, Y-COORD, ZELEV, ZHILL, ZFLAG)  
(METERS)

```

( 422050.9, 3734610.2, 36.0, 36.0, 7.0); ( 422062.3,
3734610.2, 36.0, 36.0, 7.0);
( 422073.7, 3734610.2, 36.0, 36.0, 7.0); ( 422085.0,
3734610.2, 36.0, 36.0, 7.0);
( 422096.4, 3734610.2, 36.0, 36.0, 7.0); ( 422107.8,
3734610.2, 36.0, 36.0, 7.0);
( 422119.2, 3734610.2, 36.0, 36.0, 7.0); ( 422130.6,
3734610.2, 36.0, 36.0, 7.0);
( 421948.5, 3734618.9, 36.0, 36.0, 7.0); ( 421959.9,
3734618.9, 36.0, 36.0, 7.0);
( 421971.2, 3734618.9, 36.0, 36.0, 7.0); ( 421982.6,
3734618.9, 36.0, 36.0, 7.0);
( 421994.0, 3734618.9, 36.0, 36.0, 7.0); ( 422005.4,
3734618.9, 36.0, 36.0, 7.0);
( 422016.8, 3734618.9, 36.0, 36.0, 7.0); ( 422028.1,
3734618.9, 36.0, 36.0, 7.0);
( 422039.5, 3734618.9, 36.0, 36.0, 7.0); ( 422050.9,
3734618.9, 36.0, 36.0, 7.0);
( 422062.3, 3734618.9, 36.0, 36.0, 7.0); ( 422073.7,
3734618.9, 36.0, 36.0, 7.0);
( 422085.0, 3734618.9, 36.0, 36.0, 7.0); ( 422096.4,
3734618.9, 36.0, 36.0, 7.0);
( 422107.8, 3734618.9, 36.0, 36.0, 7.0); ( 422119.2,
3734618.9, 36.0, 36.0, 7.0);
( 422130.6, 3734618.9, 36.0, 36.0, 7.0); ( 421937.1,
3734627.5, 36.0, 36.0, 7.0);
( 421948.5, 3734627.5, 36.0, 36.0, 7.0); ( 421959.9,
3734627.5, 36.0, 36.0, 7.0);
( 421971.2, 3734627.5, 36.0, 36.0, 7.0); ( 421982.6,
3734627.5, 36.0, 36.0, 7.0);

```



( 421994.0, 3734627.5, 36.0, 36.0, 7.0); ( 422005.4,  
 3734627.5, 36.0, 36.0, 7.0);  
 ( 422016.8, 3734627.5, 36.0, 36.0, 7.0); ( 422028.1,  
 3734627.5, 36.0, 36.0, 7.0);  
 ( 422039.5, 3734627.5, 36.0, 36.0, 7.0); ( 422050.9,  
 3734627.5, 36.0, 36.0, 7.0);  
 ( 422062.3, 3734627.5, 36.0, 36.0, 7.0); ( 422073.7,  
 3734627.5, 36.0, 36.0, 7.0);  
 ( 422085.0, 3734627.5, 36.0, 36.0, 7.0); ( 422096.4,  
 3734627.5, 36.0, 36.0, 7.0);  
 ( 422107.8, 3734627.5, 36.0, 36.0, 7.0); ( 422119.2,  
 3734627.5, 36.0, 36.0, 7.0);  
 ( 422130.6, 3734627.5, 36.0, 36.0, 7.0); ( 421937.1,  
 3734636.2, 36.0, 36.0, 7.0);  
 ( 421948.5, 3734636.2, 36.0, 36.0, 7.0); ( 421959.9,  
 3734636.2, 36.0, 36.0, 7.0);  
 ( 421971.2, 3734636.2, 36.0, 36.0, 7.0); ( 421982.6,  
 3734636.2, 36.0, 36.0, 7.0);  
 ( 421994.0, 3734636.2, 36.0, 36.0, 7.0); ( 422005.4,  
 3734636.2, 36.0, 36.0, 7.0);  
 ( 422016.8, 3734636.2, 36.0, 36.0, 7.0); ( 422028.1,  
 3734636.2, 36.0, 36.0, 7.0);  
 ( 422039.5, 3734636.2, 36.0, 36.0, 7.0); ( 422050.9,  
 3734636.2, 36.0, 36.0, 7.0);  
 ( 422062.3, 3734636.2, 36.0, 36.0, 7.0); ( 422073.7,  
 3734636.2, 36.0, 36.0, 7.0);  
 ( 422085.0, 3734636.2, 36.0, 36.0, 7.0); ( 422096.4,  
 3734636.2, 36.0, 36.0, 7.0);  
 ( 422107.8, 3734636.2, 36.0, 36.0, 7.0); ( 422119.2,  
 3734636.2, 36.0, 36.0, 7.0);  
 ( 422130.6, 3734636.2, 36.0, 36.0, 7.0); ( 421937.1,  
 3734644.9, 36.0, 36.0, 7.0);  
 ( 421948.5, 3734644.9, 36.0, 36.0, 7.0); ( 421959.9,  
 3734644.9, 36.0, 36.0, 7.0);  
 ( 421971.2, 3734644.9, 36.0, 36.0, 7.0); ( 421982.6,  
 3734644.9, 36.0, 36.0, 7.0);  
 ( 421994.0, 3734644.9, 36.0, 36.0, 7.0); ( 422005.4,  
 3734644.9, 36.0, 36.0, 7.0);  
 ( 422016.8, 3734644.9, 36.0, 36.0, 7.0); ( 422028.1,  
 3734644.9, 36.0, 36.0, 7.0);  
 ( 422039.5, 3734644.9, 36.0, 36.0, 7.0); ( 422050.9,  
 3734644.9, 36.0, 36.0, 7.0);  
 ( 422062.3, 3734644.9, 36.0, 36.0, 7.0); ( 422073.7,  
 3734644.9, 36.0, 36.0, 7.0);  
 ( 422085.0, 3734644.9, 36.0, 36.0, 7.0); ( 422096.4,  
 3734644.9, 36.0, 36.0, 7.0);  
 ( 422107.8, 3734644.9, 36.0, 36.0, 7.0); ( 422119.2,  
 3734644.9, 36.0, 36.0, 7.0);  
 ( 422130.6, 3734644.9, 36.0, 36.0, 7.0); ( 421925.7,  
 3734653.5, 36.0, 36.0, 7.0);

```

( 421937.1, 3734653.5, 36.0, 36.0, 7.0); ( 421948.5,
3734653.5, 36.0, 36.0, 7.0);
( 421959.9, 3734653.5, 36.0, 36.0, 7.0); ( 421971.2,
3734653.5, 36.0, 36.0, 7.0);
( 421982.6, 3734653.5, 36.0, 36.0, 7.0); ( 421994.0,
3734653.5, 36.0, 36.0, 7.0);
( 422005.4, 3734653.5, 36.0, 36.0, 7.0); ( 422016.8,
3734653.5, 36.0, 36.0, 7.0);
( 422028.1, 3734653.5, 36.0, 36.0, 7.0); ( 422039.5,
3734653.5, 36.0, 36.0, 7.0);
^ *** AERMOD - VERSION 19191 *** *** C:\LAKES\AERMOD VIEW\1660 E FIRST ST\1660
E FIRST ST.ISC *** 06/05/20
*** AERMET - VERSION 16216 *** ***
*** 02:17:27

```

PAGE 7

\*\*\* MODELOPTs: RegDEFAULT CONC ELEV FLGPOL URBAN ADJ\_U\*

\*\*\* DISCRETE CARTESIAN RECEPTORS \*\*\*  
(X-COORD, Y-COORD, ZELEV, ZHILL, ZFLAG)  
(METERS)

```

( 422050.9, 3734653.5, 36.0, 36.0, 7.0); ( 422062.3,
3734653.5, 36.0, 36.0, 7.0);
( 422073.7, 3734653.5, 36.0, 36.0, 7.0); ( 422085.0,
3734653.5, 36.0, 36.0, 7.0);
( 422096.4, 3734653.5, 36.0, 36.0, 7.0); ( 422107.8,
3734653.5, 36.0, 36.0, 7.0);
( 422119.2, 3734653.5, 36.0, 36.0, 7.0); ( 422130.6,
3734653.5, 36.0, 36.0, 7.0);
( 421925.7, 3734662.2, 36.0, 36.0, 7.0); ( 421937.1,
3734662.2, 36.0, 36.0, 7.0);
( 421948.5, 3734662.2, 36.0, 36.0, 7.0); ( 421959.9,
3734662.2, 36.0, 36.0, 7.0);
( 421971.2, 3734662.2, 36.0, 36.0, 7.0); ( 421982.6,
3734662.2, 36.0, 36.0, 7.0);
( 421994.0, 3734662.2, 36.0, 36.0, 7.0); ( 422005.4,
3734662.2, 36.0, 36.0, 7.0);
( 422016.8, 3734662.2, 36.0, 36.0, 7.0); ( 422028.1,
3734662.2, 36.0, 36.0, 7.0);
( 422039.5, 3734662.2, 36.0, 36.0, 7.0); ( 422050.9,
3734662.2, 36.0, 36.0, 7.0);
( 422062.3, 3734662.2, 36.0, 36.0, 7.0); ( 422073.7,
3734662.2, 36.0, 36.0, 7.0);
( 422085.0, 3734662.2, 36.0, 36.0, 7.0); ( 422096.4,
3734662.2, 36.0, 36.0, 7.0);
( 422107.8, 3734662.2, 36.0, 36.0, 7.0); ( 422119.2,
3734662.2, 36.0, 36.0, 7.0);
( 422130.6, 3734662.2, 36.0, 36.0, 7.0); ( 421925.7,
3734670.9, 36.1, 36.1, 7.0);

```

( 421937.1, 3734670.9, 36.1, 36.1, 7.0); ( 421948.5,  
 3734670.9, 36.1, 36.1, 7.0);  
 ( 421959.9, 3734670.9, 36.1, 36.1, 7.0); ( 421971.2,  
 3734670.9, 36.1, 36.1, 7.0);  
 ( 421982.6, 3734670.9, 36.1, 36.1, 7.0); ( 421994.0,  
 3734670.9, 36.1, 36.1, 7.0);  
 ( 422005.4, 3734670.9, 36.1, 36.1, 7.0); ( 422016.8,  
 3734670.9, 36.1, 36.1, 7.0);  
 ( 422028.1, 3734670.9, 36.1, 36.1, 7.0); ( 422039.5,  
 3734670.9, 36.1, 36.1, 7.0);  
 ( 422050.9, 3734670.9, 36.1, 36.1, 7.0); ( 422062.3,  
 3734670.9, 36.1, 36.1, 7.0);  
 ( 422073.7, 3734670.9, 36.1, 36.1, 7.0); ( 422085.0,  
 3734670.9, 36.1, 36.1, 7.0);  
 ( 422096.4, 3734670.9, 36.1, 36.1, 7.0); ( 422107.8,  
 3734670.9, 36.1, 36.1, 7.0);  
 ( 422119.2, 3734670.9, 36.1, 36.1, 7.0); ( 422130.6,  
 3734670.9, 36.1, 36.1, 7.0);  
 ( 421925.7, 3734679.5, 36.2, 36.2, 7.0); ( 421937.1,  
 3734679.5, 36.2, 36.2, 7.0);  
 ( 421948.5, 3734679.5, 36.2, 36.2, 7.0); ( 421959.9,  
 3734679.5, 36.2, 36.2, 7.0);  
 ( 421971.2, 3734679.5, 36.2, 36.2, 7.0); ( 421982.6,  
 3734679.5, 36.2, 36.2, 7.0);  
 ( 421994.0, 3734679.5, 36.2, 36.2, 7.0); ( 422005.4,  
 3734679.5, 36.2, 36.2, 7.0);  
 ( 422016.8, 3734679.5, 36.2, 36.2, 7.0); ( 422028.1,  
 3734679.5, 36.2, 36.2, 7.0);  
 ( 422039.5, 3734679.5, 36.2, 36.2, 7.0); ( 422050.9,  
 3734679.5, 36.2, 36.2, 7.0);  
 ( 422062.3, 3734679.5, 36.2, 36.2, 7.0); ( 422073.7,  
 3734679.5, 36.2, 36.2, 7.0);  
 ( 422085.0, 3734679.5, 36.2, 36.2, 7.0); ( 422096.4,  
 3734679.5, 36.2, 36.2, 7.0);  
 ( 422107.8, 3734679.5, 36.2, 36.2, 7.0); ( 422119.2,  
 3734679.5, 36.2, 36.2, 7.0);  
 ( 422130.6, 3734679.5, 36.2, 36.2, 7.0); ( 421914.3,  
 3734688.2, 36.3, 36.3, 7.0);  
 ( 421925.7, 3734688.2, 36.3, 36.3, 7.0); ( 421937.1,  
 3734688.2, 36.3, 36.3, 7.0);  
 ( 421948.5, 3734688.2, 36.3, 36.3, 7.0); ( 421959.9,  
 3734688.2, 36.3, 36.3, 7.0);  
 ( 421971.2, 3734688.2, 36.3, 36.3, 7.0); ( 421982.6,  
 3734688.2, 36.3, 36.3, 7.0);  
 ( 421994.0, 3734688.2, 36.3, 36.3, 7.0); ( 422005.4,  
 3734688.2, 36.3, 36.3, 7.0);  
 ( 422016.8, 3734688.2, 36.3, 36.3, 7.0); ( 422028.1,  
 3734688.2, 36.3, 36.3, 7.0);  
 ( 422039.5, 3734688.2, 36.3, 36.3, 7.0); ( 422050.9,  
 3734688.2, 36.3, 36.3, 7.0);

```

( 422062.3, 3734688.2, 36.3, 36.3, 7.0); ( 422073.7,
3734688.2, 36.3, 36.3, 7.0);
( 422085.0, 3734688.2, 36.3, 36.3, 7.0); ( 422096.4,
3734688.2, 36.3, 36.3, 7.0);
( 422107.8, 3734688.2, 36.3, 36.3, 7.0); ( 422119.2,
3734688.2, 36.3, 36.3, 7.0);
( 422130.6, 3734688.2, 36.3, 36.3, 7.0); ( 421914.3,
3734696.9, 36.4, 36.4, 7.0);
( 421925.7, 3734696.9, 36.4, 36.4, 7.0); ( 421937.1,
3734696.9, 36.4, 36.4, 7.0);
( 421948.5, 3734696.9, 36.4, 36.4, 7.0); ( 421959.9,
3734696.9, 36.4, 36.4, 7.0);
^ *** AERMOD - VERSION 19191 *** *** C:\LAKES\AERMOD VIEW\1660 E FIRST ST\1660
E FIRST ST.ISC *** 06/05/20
*** AERMET - VERSION 16216 *** ***
*** 02:17:27

```

PAGE 8

\*\*\* MODELOPTs: RegDFault CONC ELEV FLGPOL URBAN ADJ\_U\*

\*\*\* DISCRETE CARTESIAN RECEPTORS \*\*\*  
(X-COORD, Y-COORD, ZELEV, ZHILL, ZFLAG)  
(METERS)

```

( 421971.2, 3734696.9, 36.4, 36.4, 7.0); ( 421982.6,
3734696.9, 36.4, 36.4, 7.0);
( 421994.0, 3734696.9, 36.4, 36.4, 7.0); ( 422005.4,
3734696.9, 36.4, 36.4, 7.0);
( 422016.8, 3734696.9, 36.4, 36.4, 7.0); ( 422028.1,
3734696.9, 36.4, 36.4, 7.0);
( 422039.5, 3734696.9, 36.4, 36.4, 7.0); ( 422050.9,
3734696.9, 36.4, 36.4, 7.0);
( 422062.3, 3734696.9, 36.4, 36.4, 7.0); ( 422073.7,
3734696.9, 36.4, 36.4, 7.0);
( 422085.0, 3734696.9, 36.4, 36.4, 7.0); ( 422096.4,
3734696.9, 36.4, 36.4, 7.0);
( 422107.8, 3734696.9, 36.4, 36.4, 7.0); ( 422119.2,
3734696.9, 36.4, 36.4, 7.0);
( 422130.6, 3734696.9, 36.4, 36.4, 7.0); ( 421903.0,
3734705.6, 36.4, 36.4, 7.0);
( 421914.3, 3734705.6, 36.4, 36.4, 7.0); ( 421925.7,
3734705.6, 36.4, 36.4, 7.0);
( 421937.1, 3734705.6, 36.4, 36.4, 7.0); ( 421948.5,
3734705.6, 36.4, 36.4, 7.0);
( 421959.9, 3734705.6, 36.5, 36.5, 7.0); ( 421971.2,
3734705.6, 36.5, 36.5, 7.0);
( 421982.6, 3734705.6, 36.5, 36.5, 7.0); ( 421994.0,
3734705.6, 36.5, 36.5, 7.0);
( 422005.4, 3734705.6, 36.5, 36.5, 7.0); ( 422016.8,
3734705.6, 36.5, 36.5, 7.0);

```

( 422028.1, 3734705.6, 36.5, 36.5, 7.0); ( 422039.5,  
 3734705.6, 36.5, 36.5, 7.0);  
 ( 422050.9, 3734705.6, 36.5, 36.5, 7.0); ( 422062.3,  
 3734705.6, 36.5, 36.5, 7.0);  
 ( 422073.7, 3734705.6, 36.5, 36.5, 7.0); ( 422085.0,  
 3734705.6, 36.5, 36.5, 7.0);  
 ( 422096.4, 3734705.6, 36.5, 36.5, 7.0); ( 422107.8,  
 3734705.6, 36.5, 36.5, 7.0);  
 ( 422119.2, 3734705.6, 36.5, 36.5, 7.0); ( 422130.6,  
 3734705.6, 36.5, 36.5, 7.0);  
 ( 421903.0, 3734714.2, 36.5, 36.5, 7.0); ( 421914.3,  
 3734714.2, 36.5, 36.5, 7.0);  
 ( 421925.7, 3734714.2, 36.5, 36.5, 7.0); ( 421937.1,  
 3734714.2, 36.5, 36.5, 7.0);  
 ( 421948.5, 3734714.2, 36.5, 36.5, 7.0); ( 421959.9,  
 3734714.2, 36.5, 36.5, 7.0);  
 ( 421971.2, 3734714.2, 36.5, 36.5, 7.0); ( 421982.6,  
 3734714.2, 36.5, 36.5, 7.0);  
 ( 421994.0, 3734714.2, 36.5, 36.5, 7.0); ( 422005.4,  
 3734714.2, 36.5, 36.5, 7.0);  
 ( 422016.8, 3734714.2, 36.5, 36.5, 7.0); ( 422028.1,  
 3734714.2, 36.6, 36.6, 7.0);  
 ( 422039.5, 3734714.2, 36.6, 36.6, 7.0); ( 422050.9,  
 3734714.2, 36.6, 36.6, 7.0);  
 ( 422062.3, 3734714.2, 36.6, 36.6, 7.0); ( 422073.7,  
 3734714.2, 36.6, 36.6, 7.0);  
 ( 422085.0, 3734714.2, 36.6, 36.6, 7.0); ( 422096.4,  
 3734714.2, 36.6, 36.6, 7.0);  
 ( 422107.8, 3734714.2, 36.6, 36.6, 7.0); ( 422119.2,  
 3734714.2, 36.6, 36.6, 7.0);  
 ( 422130.6, 3734714.2, 36.6, 36.6, 7.0); ( 421903.0,  
 3734722.9, 36.6, 36.6, 7.0);  
 ( 421914.3, 3734722.9, 36.6, 36.6, 7.0); ( 421925.7,  
 3734722.9, 36.6, 36.6, 7.0);  
 ( 421937.1, 3734722.9, 36.6, 36.6, 7.0); ( 421948.5,  
 3734722.9, 36.6, 36.6, 7.0);  
 ( 421959.9, 3734722.9, 36.6, 36.6, 7.0); ( 421971.2,  
 3734722.9, 36.6, 36.6, 7.0);  
 ( 421982.6, 3734722.9, 36.6, 36.6, 7.0); ( 421994.0,  
 3734722.9, 36.6, 36.6, 7.0);  
 ( 422005.4, 3734722.9, 36.6, 36.6, 7.0); ( 422016.8,  
 3734722.9, 36.6, 36.6, 7.0);  
 ( 422028.1, 3734722.9, 36.6, 36.6, 7.0); ( 422039.5,  
 3734722.9, 36.6, 36.6, 7.0);  
 ( 422050.9, 3734722.9, 36.6, 36.6, 7.0); ( 422062.3,  
 3734722.9, 36.6, 36.6, 7.0);  
 ( 422073.7, 3734722.9, 36.6, 36.6, 7.0); ( 422085.0,  
 3734722.9, 36.6, 36.6, 7.0);  
 ( 422096.4, 3734722.9, 36.7, 36.7, 7.0); ( 422107.8,  
 3734722.9, 36.7, 36.7, 7.0);



DATA \*\*\*

Surface file: KSNA\_V9\_ADJU\KSNA\_V9.SFC  
Met Version: 16216  
Profile file: KSNA\_V9\_ADJU\KSNA\_V9.PFL

Surface format: FREE

Profile format: FREE

Surface station no.: 93184  
Name: UNKNOWN

Upper air station no.: 3190  
Name: UNKNOWN

Year: 2012

Year: 2012

First 24 hours of scalar data

YR	MO	DY	JDY	HR	H0	U*	W*	DT/DZ	ZICNV	ZIMCH	M-O	LEN	Z0	BOWEN
ALBEDO	REF	WS	WD	HT	REF	TA	HT							
12	01	01	1	01	-4.5	0.082	-9.000	-9.000	-999.	56.	11.0	0.12	2.65	
1.00	0.87	62.		5.8	283.8	2.0								
12	01	01	1	02	-3.5	0.073	-9.000	-9.000	-999.	47.	9.9	0.12	2.65	
1.00	0.77	27.		5.8	283.1	2.0								
12	01	01	1	03	-3.5	0.073	-9.000	-9.000	-999.	47.	9.9	0.12	2.65	
1.00	0.77	336.		5.8	283.1	2.0								
12	01	01	1	04	-3.3	0.070	-9.000	-9.000	-999.	45.	9.7	0.12	2.65	
1.00	0.74	34.		5.8	283.1	2.0								
12	01	01	1	05	-3.0	0.068	-9.000	-9.000	-999.	42.	9.4	0.12	2.65	
1.00	0.70	154.		5.8	282.5	2.0								
12	01	01	1	06	-999.0	-9.000	-9.000	-9.000	-999.	-999.	-99999.0	0.12	2.65	
1.00	0.00	0.		5.8	282.0	2.0								
12	01	01	1	07	-2.0	0.059	-9.000	-9.000	-999.	34.	9.0	0.12	2.65	
1.00	0.55	343.		5.8	281.4	2.0								
12	01	01	1	08	-2.6	0.066	-9.000	-9.000	-999.	40.	9.7	0.12	2.65	
0.53	0.69	25.		5.8	281.4	2.0								
12	01	01	1	09	21.6	0.133	0.252	0.010	27.	116.	-9.9	0.12	2.65	
0.31	1.03	344.		5.8	282.5	2.0								
12	01	01	1	10	115.6	0.162	0.713	0.008	114.	156.	-3.3	0.12	2.65	
0.24	1.06	233.		5.8	286.4	2.0								
12	01	01	1	11	160.9	0.126	1.129	0.005	325.	108.	-1.1	0.12	2.65	
0.21	0.67	261.		5.8	291.4	2.0								
12	01	01	1	12	187.0	0.138	1.467	0.005	614.	123.	-1.3	0.12	2.65	
0.20	0.75	252.		5.8	294.9	2.0								
12	01	01	1	13	186.9	0.189	1.755	0.005	1051.	197.	-3.3	0.12	2.65	
0.20	1.23	280.		5.8	297.5	2.0								
12	01	01	1	14	168.3	0.247	1.857	0.005	1383.	295.	-8.1	0.12	2.65	
0.21	1.86	268.		5.8	299.2	2.0								
12	01	01	1	15	115.3	0.275	1.688	0.005	1517.	346.	-16.3	0.12	2.65	
0.24	2.25	248.		5.8	298.1	2.0								





3734566.84	0.09644		
421982.63	3734566.84	0.08740	421994.01
3734566.84	0.07937		
422005.39	3734566.84	0.07220	422016.77
3734566.84	0.06580		
422028.15	3734566.84	0.06006	422039.53
3734566.84	0.05491		
422050.91	3734566.84	0.05028	422062.29
3734566.84	0.04614		
422073.67	3734566.84	0.04242	422085.05
3734566.84	0.03907		
422096.43	3734566.84	0.03608	422107.81
3734566.84	0.03340		
422119.19	3734566.84	0.03098	422130.57
3734566.84	0.02881		
421959.87	3734575.51	0.10469	421971.25
3734575.51	0.09489		
421982.63	3734575.51	0.08620	421994.01
3734575.51	0.07846		
422005.39	3734575.51	0.07156	422016.77
3734575.51	0.06537		
422028.15	3734575.51	0.05981	422039.53
3734575.51	0.05481		
422050.91	3734575.51	0.05031	422062.29
3734575.51	0.04625		
422073.67	3734575.51	0.04260	422085.05
3734575.51	0.03932		
422096.43	3734575.51	0.03636	422107.81
3734575.51	0.03370		
422119.19	3734575.51	0.03129	422130.57
3734575.51	0.02913		
421959.87	3734584.18	0.10300	421971.25
3734584.18	0.09351		
421982.63	3734584.18	0.08510	421994.01
3734584.18	0.07763		
422005.39	3734584.18	0.07095	422016.77
3734584.18	0.06496		
422028.15	3734584.18	0.05957	422039.53
3734584.18	0.05471		
422050.91	3734584.18	0.05032	422062.29
3734584.18	0.04635		
422073.67	3734584.18	0.04276	422085.05
3734584.18	0.03953		
422096.43	3734584.18	0.03661	422107.81
3734584.18	0.03397		
422119.19	3734584.18	0.03158	422130.57
3734584.18	0.02942		
421959.87	3734592.85	0.10129	421971.25
3734592.85	0.09209		
421982.63	3734592.85	0.08396	421994.01



Y-COORD (M)	CONC		
422130.57	3734601.52	0.02991	421948.49
3734610.19	0.10746		
421959.87	3734610.19	0.09772	421971.25
3734610.19	0.08915		
421982.63	3734610.19	0.08158	421994.01
3734610.19	0.07485		
422005.39	3734610.19	0.06883	422016.77
3734610.19	0.06340		
422028.15	3734610.19	0.05849	422039.53
3734610.19	0.05403		
422050.91	3734610.19	0.04998	422062.29
3734610.19	0.04629		
422073.67	3734610.19	0.04292	422085.05
3734610.19	0.03986		
422096.43	3734610.19	0.03707	422107.81
3734610.19	0.03453		
422119.19	3734610.19	0.03221	422130.57
3734610.19	0.03010		
421948.49	3734618.86	0.10525	421959.87
3734618.86	0.09588		
421971.25	3734618.86	0.08764	421982.63
3734618.86	0.08034		
421994.01	3734618.86	0.07385	422005.39
3734618.86	0.06804		
422016.77	3734618.86	0.06279	422028.15
3734618.86	0.05803		
422039.53	3734618.86	0.05371	422050.91
3734618.86	0.04976		
422062.29	3734618.86	0.04617	422073.67
3734618.86	0.04288		
422085.05	3734618.86	0.03988	422096.43
3734618.86	0.03714		
422107.81	3734618.86	0.03463	422119.19
3734618.86	0.03235		
422130.57	3734618.86	0.03026	421937.11
3734627.53	0.11329		
421948.49	3734627.53	0.10305	421959.87
3734627.53	0.09404		
421971.25	3734627.53	0.08611	421982.63
3734627.53	0.07909		
421994.01	3734627.53	0.07283	422005.39
3734627.53	0.06721		
422016.77	3734627.53	0.06214	422028.15
3734627.53	0.05753		
422039.53	3734627.53	0.05334	422050.91
3734627.53	0.04950		
422062.29	3734627.53	0.04600	422073.67



\*\* CONC OF DPM IN MICROGRAMS/M\*\*3

\*\*

Y-COORD (M)	X-COORD (M)	Y-COORD (M)	CONC	X-COORD (M)
3734644.87	422039.53	3734644.87	0.05248	422050.91
3734644.87	422062.29	3734644.87	0.04555	422073.67
3734644.87	422085.05	3734644.87	0.03970	422096.43
3734644.87	422107.81	3734644.87	0.03475	422119.19
3734653.54	422130.57	3734644.87	0.03055	421925.73
3734653.54	421937.11	3734653.54	0.10560	421948.49
3734653.54	421959.87	3734653.54	0.08851	421971.25
3734653.54	421982.63	3734653.54	0.07522	421994.01
3734653.54	422005.39	3734653.54	0.06457	422016.77
3734653.54	422028.15	3734653.54	0.05583	422039.53
3734653.54	422050.91	3734653.54	0.04850	422062.29
3734653.54	422073.67	3734653.54	0.04231	422085.05
3734653.54	422096.43	3734653.54	0.03705	422107.81
3734653.54	422119.19	3734653.54	0.03258	422130.57
3734662.21	421925.73	3734662.21	0.11286	421937.11
3734662.21	421948.49	3734662.21	0.09429	421959.87
3734662.21	421971.25	3734662.21	0.07991	421982.63
3734662.21	421994.01	3734662.21	0.06851	422005.39
3734662.21	422016.77	3734662.21	0.05923	422028.15
3734662.21	422039.53	3734662.21	0.05150	422050.91
3734662.21	422062.29	3734662.21	0.04497	422073.67
3734662.21	422085.05	3734662.21	0.03941	422096.43

3734662.21	0.03694			
422107.81	3734662.21	0.03467		422119.19
3734662.21	0.03256			
422130.57	3734662.21	0.03062		421925.73
3734670.88	0.10923			
421937.11	3734670.88	0.09997		421948.49
3734670.88	0.09179			
421959.87	3734670.88	0.08456		421971.25
3734670.88	0.07814			
421982.63	3734670.88	0.07241		421994.01
3734670.88	0.06726			
422005.39	3734670.88	0.06260		422016.77
3734670.88	0.05835			
422028.15	3734670.88	0.05447		422039.53
3734670.88	0.05090			
422050.91	3734670.88	0.04762		422062.29
3734670.88	0.04459			
422073.67	3734670.88	0.04178		422085.05
3734670.88	0.03919			
422096.43	3734670.88	0.03679		422107.81
3734670.88	0.03456			
422119.19	3734670.88	0.03250		422130.57
3734670.88	0.03059			
421925.73	3734679.55	0.10561		421937.11
3734679.55	0.09697			
421948.49	3734679.55	0.08928		421959.87
3734679.55	0.08246			
421971.25	3734679.55	0.07635		421982.63
3734679.55	0.07090			
421994.01	3734679.55	0.06598		422005.39
3734679.55	0.06152			
422016.77	3734679.55	0.05745		422028.15
3734679.55	0.05372			
422039.53	3734679.55	0.05029		422050.91
3734679.55	0.04712			
422062.29	3734679.55	0.04418		422073.67
3734679.55	0.04147			

▲ \*\*\* AERMOD - VERSION 19191 \*\*\*      \*\*\* C:\LAKES\AERMOD VIEW\1660 E FIRST ST\1660  
 E FIRST ST.ISC                            \*\*\*                            06/05/20  
 \*\*\* AERMET - VERSION 16216 \*\*\*      \*\*\*  
    \*\*\*                            02:17:27

PAGE 14

\*\*\* MODELOPTs:    RegDFault    CONC    ELEV    FLGPOL    URBAN    ADJ\_U\*

\*\*\* THE ANNUAL AVERAGE CONCENTRATION      VALUES AVERAGED OVER    5  
 YEARS FOR SOURCE GROUP: ALL                    \*\*\*

INCLUDING SOURCE(S):    L0000001    ,    L0000002  
 ,    L0000003    ,    L0000004    ,    L0000005    ,  
    L0000006    ,    L0000007    ,    L0000008    ,    L0000009    ,

\*\*\* DISCRETE CARTESIAN RECEPTOR POINTS

\*\*\*

		** CONC OF DPM	IN MICROGRAMS/M**3
		**	
X-COORD (M)	Y-COORD (M)	CONC	X-COORD (M)
Y-COORD (M)	CONC		
422085.05	3734679.55	0.03894	422096.43
3734679.55	0.03660		
422107.81	3734679.55	0.03443	422119.19
3734679.55	0.03242		
422130.57	3734679.55	0.03055	421914.35
3734688.22	0.11117		
421925.73	3734688.22	0.10207	421937.11
3734688.22	0.09399		
421948.49	3734688.22	0.08679	421959.87
3734688.22	0.08036		
421971.25	3734688.22	0.07460	421982.63
3734688.22	0.06941		
421994.01	3734688.22	0.06472	422005.39
3734688.22	0.06045		
422016.77	3734688.22	0.05655	422028.15
3734688.22	0.05296		
422039.53	3734688.22	0.04965	422050.91
3734688.22	0.04659		
422062.29	3734688.22	0.04375	422073.67
3734688.22	0.04112		
422085.05	3734688.22	0.03867	422096.43
3734688.22	0.03640		
422107.81	3734688.22	0.03428	422119.19
3734688.22	0.03231		
422130.57	3734688.22	0.03048	421914.35
3734696.89	0.10719		
421925.73	3734696.89	0.09871	421937.11
3734696.89	0.09114		
421948.49	3734696.89	0.08438	421959.87
3734696.89	0.07831		
421971.25	3734696.89	0.07286	421982.63
3734696.89	0.06793		
421994.01	3734696.89	0.06346	422005.39
3734696.89	0.05937		
422016.77	3734696.89	0.05563	422028.15
3734696.89	0.05219		
422039.53	3734696.89	0.04900	422050.91
3734696.89	0.04605		
422062.29	3734696.89	0.04331	422073.67

3734696.89	0.04076			
422085.05	3734696.89	0.03839		422096.43
3734696.89	0.03618			
422107.81	3734696.89	0.03412		422119.19
3734696.89	0.03219			
422130.57	3734696.89	0.03040		421902.97
3734705.56	0.11236			
421914.35	3734705.56	0.10343		421925.73
3734705.56	0.09548			
421937.11	3734705.56	0.08838		421948.49
3734705.56	0.08202			
421959.87	3734705.56	0.07628		421971.25
3734705.56	0.07113			
421982.63	3734705.56	0.06645		421994.01
3734705.56	0.06219			
422005.39	3734705.56	0.05829		422016.77
3734705.56	0.05471			
422028.15	3734705.56	0.05141		422039.53
3734705.56	0.04835			
422050.91	3734705.56	0.04550		422062.29
3734705.56	0.04286			
422073.67	3734705.56	0.04038		422085.05
3734705.56	0.03808			
422096.43	3734705.56	0.03593		422107.81
3734705.56	0.03393			
422119.19	3734705.56	0.03205		422130.57
3734705.56	0.03030			
421902.97	3734714.23	0.10817		421914.35
3734714.23	0.09976			
421925.73	3734714.23	0.09232		421937.11
3734714.23	0.08567			
421948.49	3734714.23	0.07970		421959.87
3734714.23	0.07432			
421971.25	3734714.23	0.06944		421982.63
3734714.23	0.06500			
421994.01	3734714.23	0.06094		422005.39
3734714.23	0.05722			
422016.77	3734714.23	0.05379		422028.15
3734714.23	0.05061			
422039.53	3734714.23	0.04767		422050.91
3734714.23	0.04493			

```

^ *** AERMOD - VERSION 19191 *** *** C:\LAKES\AERMOD VIEW\1660 E FIRST ST\1660
E FIRST ST.ISC *** 06/05/20
*** AERMET - VERSION 16216 *** ***
***
02:17:27

```

PAGE 15

\*\*\* MODELOPTs: RegDEFAULT CONC ELEV FLGPOL URBAN ADJ\_U\*

\*\*\* THE ANNUAL AVERAGE CONCENTRATION VALUES AVERAGED OVER 5



YEARS FOR SOURCE GROUP: ALL

\*\*\*

INCLUDING SOURCE(S): L0000001 , L0000002  
, L0000003 , L0000004 , L0000005 ,  
L0000006 , L0000007 , L0000008 , L0000009 ,

\*\*\* DISCRETE CARTESIAN RECEPTOR POINTS

\*\*\*

\*\* CONC OF DPM IN MICROGRAMS/M\*\*3

\*\*

X-COORD (M)	Y-COORD (M)	CONC	X-COORD (M)
Y-COORD (M)	CONC		
422062.29	3734714.23	0.04238	422073.67
3734714.23	0.03999		
422085.05	3734714.23	0.03776	422096.43
3734714.23	0.03568		
422107.81	3734714.23	0.03372	422119.19
3734714.23	0.03190		
422130.57	3734714.23	0.03019	421902.97
3734722.90	0.10408		
421914.35	3734722.90	0.09628	421925.73
3734722.90	0.08932		
421937.11	3734722.90	0.08308	421948.49
3734722.90	0.07747		
421959.87	3734722.90	0.07239	421971.25
3734722.90	0.06778		
421982.63	3734722.90	0.06355	421994.01
3734722.90	0.05969		
422005.39	3734722.90	0.05614	422016.77
3734722.90	0.05286		
422028.15	3734722.90	0.04982	422039.53
3734722.90	0.04699		
422050.91	3734722.90	0.04436	422062.29
3734722.90	0.04189		
422073.67	3734722.90	0.03959	422085.05
3734722.90	0.03743		
422096.43	3734722.90	0.03540	422107.81
3734722.90	0.03350		
422119.19	3734722.90	0.03172	422130.57
3734722.90	0.03005		

▲ \*\*\* AERMOD - VERSION 19191 \*\*\*  
E FIRST ST.ISC \*\*\*

\*\*\* C:\LAKES\AERMOD VIEW\1660 E FIRST ST\1660  
06/05/20

\*\*\* AERMET - VERSION 16216 \*\*\*  
\*\*\*

\*\*\*  
02:17:27

PAGE 16

\*\*\* MODELOPTs: RegDEFAULT CONC ELEV FLGPOL URBAN ADJ\_U\*

\*\*\* THE SUMMARY OF MAXIMUM ANNUAL RESULTS

AVERAGED OVER 5 YEARS \*\*\*

\*\* CONC OF DPM IN MICROGRAMS/M\*\*3

\*\*

GROUP ID	NETWORK	AVERAGE CONC	RECEPTOR (XR, YR,
ZELEV, ZHILL, ZFLAG)	OF TYPE	GRID-ID	
ALL	1ST HIGHEST VALUE IS	0.11599 AT (	421925.73, 3734653.54,
36.00,	36.00, 7.00) DC		
	2ND HIGHEST VALUE IS	0.11329 AT (	421937.11, 3734627.53,
36.00,	36.00, 7.00) DC		
	3RD HIGHEST VALUE IS	0.11286 AT (	421925.73, 3734662.21,
36.00,	36.00, 7.00) DC		
	4TH HIGHEST VALUE IS	0.11236 AT (	421902.97, 3734705.56,
36.45,	36.45, 7.00) DC		
	5TH HIGHEST VALUE IS	0.11117 AT (	421914.35, 3734688.22,
36.26,	36.26, 7.00) DC		
	6TH HIGHEST VALUE IS	0.11073 AT (	421937.11, 3734636.20,
36.00,	36.00, 7.00) DC		
	7TH HIGHEST VALUE IS	0.10963 AT (	421948.49, 3734601.52,
36.00,	36.00, 7.00) DC		
	8TH HIGHEST VALUE IS	0.10923 AT (	421925.73, 3734670.88,
36.08,	36.08, 7.00) DC		
	9TH HIGHEST VALUE IS	0.10818 AT (	421937.11, 3734644.87,
36.00,	36.00, 7.00) DC		
	10TH HIGHEST VALUE IS	0.10817 AT (	421902.97, 3734714.23,
36.54,	36.54, 7.00) DC		

\*\*\* RECEPTOR TYPES: GC = GRIDCART  
 GP = GRIDPOLR  
 DC = DISCCART  
 DP = DISCPOLR

▲ \*\*\* AERMOD - VERSION 19191 \*\*\* \*\*\* C:\LAKES\AERMOD VIEW\1660 E FIRST ST\1660  
 E FIRST ST.ISC \*\*\* 06/05/20  
 \*\*\* AERMET - VERSION 16216 \*\*\* \*\*\*  
 \*\*\* 02:17:27

PAGE 17

\*\*\* MODELOPTs: RegDEFAULT CONC ELEV FLGPOL URBAN ADJ\_U\*

\*\*\* Message Summary : AERMOD Model Execution \*\*\*

----- Summary of Total Messages -----

A Total of                    0 Fatal Error Message(s)  
A Total of                    2 Warning Message(s)  
A Total of                    1864 Informational Message(s)  
  
A Total of                    43848 Hours Were Processed  
  
A Total of                    1500 Calm Hours Identified  
  
A Total of                    364 Missing Hours Identified ( 0.83 Percent)

\*\*\*\*\* FATAL ERROR MESSAGES \*\*\*\*\*  
\*\*\* NONE \*\*\*

\*\*\*\*\* WARNING MESSAGES \*\*\*\*\*  
ME W186            99            MEOPEN: THRESH\_1MIN 1-min ASOS wind speed threshold used  
                  0.50  
ME W187            99            MEOPEN: ADJ\_U\* Option for Stable Low Winds used in AERMET

\*\*\*\*\*  
\*\*\* AERMOD Finishes Successfully \*\*\*  
\*\*\*\*\*

# EXHIBIT 12

1 - 113

REVISED TRAFFIC IMPACT ANALYSIS REPORT  
4<sup>TH</sup> AND CABRILLO MIXED-USE PROJECT  
CENTRAL POINTE  
Santa Ana, California  
July 30, 2020 (Original dated August 27, 2019)

Prepared for:  
ARNEL & AFFILIATES  
949 South Coast Drive, 6<sup>th</sup> Floor  
Costa Mesa, CA 92626



Prepared by:  
Shane S. Green, P.E.  
Transportation Engineer III  
&  
Megan Lam  
Transportation Engineer II

LLG Ref. 2-19-4141-1



Under the Supervision of:  
Richard E. Barretto, P.E.  
Principal

SPR No. 2020-04  
1801 East Fourth Street  
Central Pointe Mixed Use Development  
Exhibit 12 – Traffic Impact Analysis

Linscott, Law &  
Greenspan, Engineers  
2 Executive Circle  
Suite 250  
Irvine, CA 92614  
949.825.6175 T  
949.825.6173 F  
www.llgengineers.com

# TABLE OF CONTENTS

SECTION	PAGE
<b>1.0 Introduction</b> .....	<b>1</b>
1.1 Scope of Work .....	1
1.2 Study Area .....	2
<b>2.0 Project Description</b> .....	<b>4</b>
2.1 Site Access .....	4
2.2 Pedestrian Circulation .....	4
<b>3.0 Existing Conditions</b> .....	<b>6</b>
3.1 Existing Street System .....	6
3.1.1 Public Transit .....	7
3.2 Bicycle Master Plan .....	7
3.3 Existing Traffic Volumes.....	8
3.4 Existing Intersection Conditions.....	8
3.4.1 Intersection Capacity Utilization (ICU) Method of Analysis .....	8
3.4.2 Highway Capacity Manual 6 (HCM 6) Method of Analysis (Unsignalized Intersections).....	9
3.4.3 Level of Service Criteria .....	12
3.5 Existing Level of Service Results .....	12
<b>4.0 Traffic Forecasting Methodology</b> .....	<b>15</b>
<b>5.0 Project Traffic Characteristics</b> .....	<b>16</b>
5.1 Project Traffic Generation .....	16
5.2 Project Traffic Distribution and Assignment.....	16
5.3 Existing Plus Project Traffic Conditions .....	17
<b>6.0 Future Traffic Conditions</b> .....	<b>20</b>
6.1 Ambient Traffic Growth .....	20
6.2 Related Projects Traffic Characteristics.....	20
6.3 Year 2040 Traffic Conditions .....	25
6.4 Year 2025 and Year 2040 Traffic Volumes.....	25
6.4.1 Year 2025 Traffic Volumes .....	25
6.4.2 Year 2040 Traffic Volumes .....	25
<b>7.0 Traffic Impact Analysis Methodology</b> .....	<b>26</b>
7.1 Impact Criteria and Thresholds.....	26
7.2 Traffic Impact Analysis Scenarios.....	27
<b>8.0 Peak Hour Intersection Capacity Analysis</b> .....	<b>28</b>
8.1 Existing Plus Project Analysis .....	28
8.1.1 Existing Plus Project Traffic Conditions .....	28
8.2 Year 2025 Traffic Conditions .....	32

## TABLE OF CONTENTS (CONTINUED)

SECTION	PAGE
8.2.1 Year 2025 Cumulative Traffic Conditions .....	32
8.2.2 Year 2025 Cumulative Plus Project Conditions .....	32
8.3 Year 2040 Traffic Conditions .....	37
8.3.1 Year 2040 Traffic Conditions .....	37
8.3.2 Year 2040 Plus Project Traffic Conditions .....	37
<b>9.0 State of California (Caltrans) Analysis .....</b>	<b>42</b>
9.1 Highway Capacity Manual (HCM) Method of Analysis (Signalized Intersections) .....	42
9.2 Existing Plus Project Traffic Conditions .....	44
9.2.1 Existing Traffic Conditions .....	44
9.2.2 Existing Plus Project Traffic Conditions .....	44
9.3 Year 2025 Traffic Conditions .....	46
9.3.1 Year 2025 Cumulative Traffic Conditions .....	46
9.3.2 Year 2025 Cumulative Plus Project Traffic Conditions .....	46
9.4 Year 2040 Traffic Conditions .....	48
9.4.1 Year 2040 Buildout Traffic Conditions .....	48
9.4.2 Year 2040 Buildout Plus Project Traffic Conditions .....	48
<b>10.0 Site Access and Internal Circulation Evaluation .....</b>	<b>50</b>
10.1 Site Access .....	50
10.2 Queuing Analysis .....	50
10.2.1 Year 2040 Buildout Plus Project Traffic Conditions .....	50
10.3 Internal Circulation Evaluation .....	54
10.4 Sight Distance Evaluation .....	54
<b>11.0 Recommended Intersection Improvements .....</b>	<b>55</b>
11.1 Planned and/or Recommended Improvements .....	55
11.1.1 Existing Plus Project Traffic Conditions .....	55
11.1.2 Year 2025 Cumulative Plus Project Traffic Conditions .....	55
11.1.3 Year 2040 Buildout Plus Project Traffic Conditions .....	56
11.2 Project-Specific Improvements .....	56
11.3 Recommended Circulation Enhancement .....	56
11.4 Project-Related Fair-Share Contribution .....	57
<b>12.0 Congestion Management Program (CMP) Compliance Assessment .....</b>	<b>59</b>
<b>13.0 Summary Of Findings And Conclusions .....</b>	<b>61</b>

## APPENDICES

---

### APPENDIX

---

- A. Traffic Study Scope of Work
- B. Existing Traffic Count Data
- C. Year 2040 Modeling Worksheets
- D. Intersection Level of Service Calculation Worksheets
- E. Caltrans Intersection Level of Service Calculation Worksheets
- F. Project Driveway Level of Service Calculation Worksheets
- G. Queueing Worksheets
- H. Signal Warrant Worksheets



## LIST OF FIGURES

SECTION—FIGURE #	FOLLOWING PAGE
1-1 Vicinity Map .....	2
2-1 Existing Aerial Site Photograph .....	4
2-2 Proposed Site Plan .....	4
3-1 Existing Roadway Conditions and Intersection Controls .....	7
3-2 OCTA Transit Map .....	7
3-3 Transit Stop Locations .....	7
3-4 City of Santa Ana Bikeway Master Plan .....	7
3-5 Existing AM Peak Hour Traffic Volumes .....	8
3-6 Existing PM Peak Hour and Daily Traffic Volumes .....	8
5-1 Project Traffic Distribution Pattern .....	19
5-2 AM Peak Hour Project Traffic Volumes.....	19
5-3 PM Peak Hour and Daily Project Traffic Volumes.....	19
5-4 Existing Plus Project AM Peak Hour Traffic Volumes .....	19
5-5 Existing Plus Project PM Peak Hour and Daily Traffic Volumes.....	19
6-1 Location of Cumulative Projects .....	20
6-2 AM Peak Hour Cumulative Projects Traffic Volumes.....	20
6-3 PM Peak Hour and Daily Cumulative Projects Traffic Volumes .....	20
6-4 Year 2025 Cumulative AM Peak Hour Traffic Volumes .....	25
6-5 Year 2025 Cumulative PM Peak Hour and Daily Traffic Volumes .....	25
6-6 Year 2025 Cumulative Plus Project AM Peak Hour Traffic Volumes .....	25
6-7 Year 2025 Cumulative Plus Project PM Peak Hour and Daily Traffic Volumes .....	25
6-8 Year 2040 Buildout AM Peak Hour Traffic Volumes.....	25
6-9 Year 2040 Buildout PM Peak Hour and Daily Traffic Volumes.....	25
6-10 Year 2040 Buildout Plus Project AM Peak Hour Traffic Volumes .....	25
6-11 Year 2040 Buildout Plus Project PM Peak Hour and Daily Traffic Volumes .....	25
10-1 SU-30 Truck Turning Analysis.....	54
10-2 Project Driveways Sight Distance Analysis.....	54
11-1 Planned and Recommended Improvements.....	57
11-2 Conceptual Improvement Plan: 4 <sup>th</sup> Street from I-5 NB Ramps to Cabrillo Park Dr.....	57

## LIST OF TABLES

SECTION	TABLE #	PAGE
2-1	Project Development Summary.....	5
3-1	Level of Service Criteria For Signalized Intersections .....	10
3-2	Level of Service Criteria For Unsignalized Intersections.....	11
3-3	Existing Peak Hour Intersection Capacity Analysis .....	13-14
5-1	Project Traffic Generation Rates and Forecast .....	18
5-2	Project Directional Distribution Pattern .....	19
6-1	Location and Description of Cumulative Projects .....	21-22
6-2	Cumulative Projects Traffic Generation Forecast.....	23-24
8-1	Existing Plus Project Peak Hour Intersection Capacity Analysis .....	29-31
8-2	Year 2025 Cumulative Peak Hour Intersection Capacity Analysis .....	34-36
8-3	Year 2040 Buildout Peak Hour Intersection Capacity Analysis .....	39-41
9-1	Level of Service Criterial for Signalized Intersections (HCM) .....	43
9-2	Existing Plus Project Peak Hour Intersection Capacity Analysis - Caltrans .....	45
9-3	Year 2025 Cumulative Peak Hour Intersection Capacity Analysis - Caltrans .....	47
9-4	Year 2040 Buildout Peak Hour Intersection Capacity Analysis - Caltrans.....	49
10-1	Project Driveway Peak Hour Intersection Capacity Analysis.....	52
10-2	Year 2040 Buildout Peak Hour Queueing Analysis .....	53
11-1	Year 2040 Buildout Project Fair-Share Contribution .....	58
12-1	Project Percentage Radius of Influence CMP Analysis .....	60

REVISED TRAFFIC IMPACT ANALYSIS REPORT  
4<sup>TH</sup> AND CABRILLO MIXED-USE PROJECT  
CENTRAL POINTE

Santa Ana, California  
July 30, 2020 (Original dated August 27, 2019)

## 1.0 INTRODUCTION

This Traffic Impact Analysis report addresses the potential traffic impacts and circulation needs associated with 4<sup>th</sup> and Cabrillo Mixed-Use Project, formally named Central Pointe, (hereinafter referred to as Project) in the City of Santa Ana. The project proponent, Arnell & Affiliates, proposes to develop up to 644 apartment units, and up to 15,200 square-feet (SF) of retail/commercial floor area consisting of 3,500 SF of restaurant use and 11,700 SF of retail space. The Project site is an 8.35-acre vacant parcel of land within the Metro East Mixed-Use Overlay Zone that is generally located north of 4<sup>th</sup> Street, east of the Santa Ana (I-5) Freeway, and west of Cabrillo Park Drive.

### 1.1 Scope of Work

This traffic report documents the findings and recommendations of a traffic impact analysis conducted by Linscott, Law & Greenspan, Engineers (LLG) to determine the potential impacts associated with the proposed Project. The traffic analysis evaluates the existing operating conditions at twenty-five (25) key study intersections within the project vicinity, estimates the trip generation potential of the proposed Project, and forecasts future near-term (Year 2025) and long-term (Year 2040) operating conditions without and with the proposed Project. Where necessary, intersection improvements/mitigation measures are identified.

This revised traffic report satisfies the traffic impact requirements of the City of Santa Ana and is consistent with the current *Congestion Management Program (CMP) for Orange County* and addresses comments of City staff based on review of the draft traffic study. The Scope of Work for this traffic study, which is included in **Appendix A**, was developed in conjunction with and reflects input City of Santa Ana Public Works Department staff.

The project site has been visited and an inventory of adjacent area roadways and intersections was performed. Existing weekday peak hour traffic count information has been collected at twenty-five (25) key study intersections for use in the preparation of intersection level of service calculations. Information concerning cumulative projects (planned and/or approved) in the vicinity of the proposed Project has been researched at the City of Santa Ana and City of Tustin. Based on our research, there are twenty-eight (28) related projects located in the City of Santa Ana and two (2) related projects located in the City of Tustin. The thirty (30) related projects were considered in the cumulative traffic analysis for this project.

This traffic report analyzes existing and future weekday daily, AM peak hour and PM peak hour traffic conditions for a near-term (Year 2025) and long-term (Year 2040) traffic setting upon

completion of the proposed Project. Near-term (Year 2025) cumulative daily and peak hour traffic forecasts were projected by incorporating a one percent (1.0%) annual growth rate and the trip generation potential of thirty (30) related projects. Long-term (Year 2040) daily and peak hour traffic forecasts were projected based on modeled traffic projections prepared by OCTA utilizing the OCTAM 4.0 Year 2040 Model.

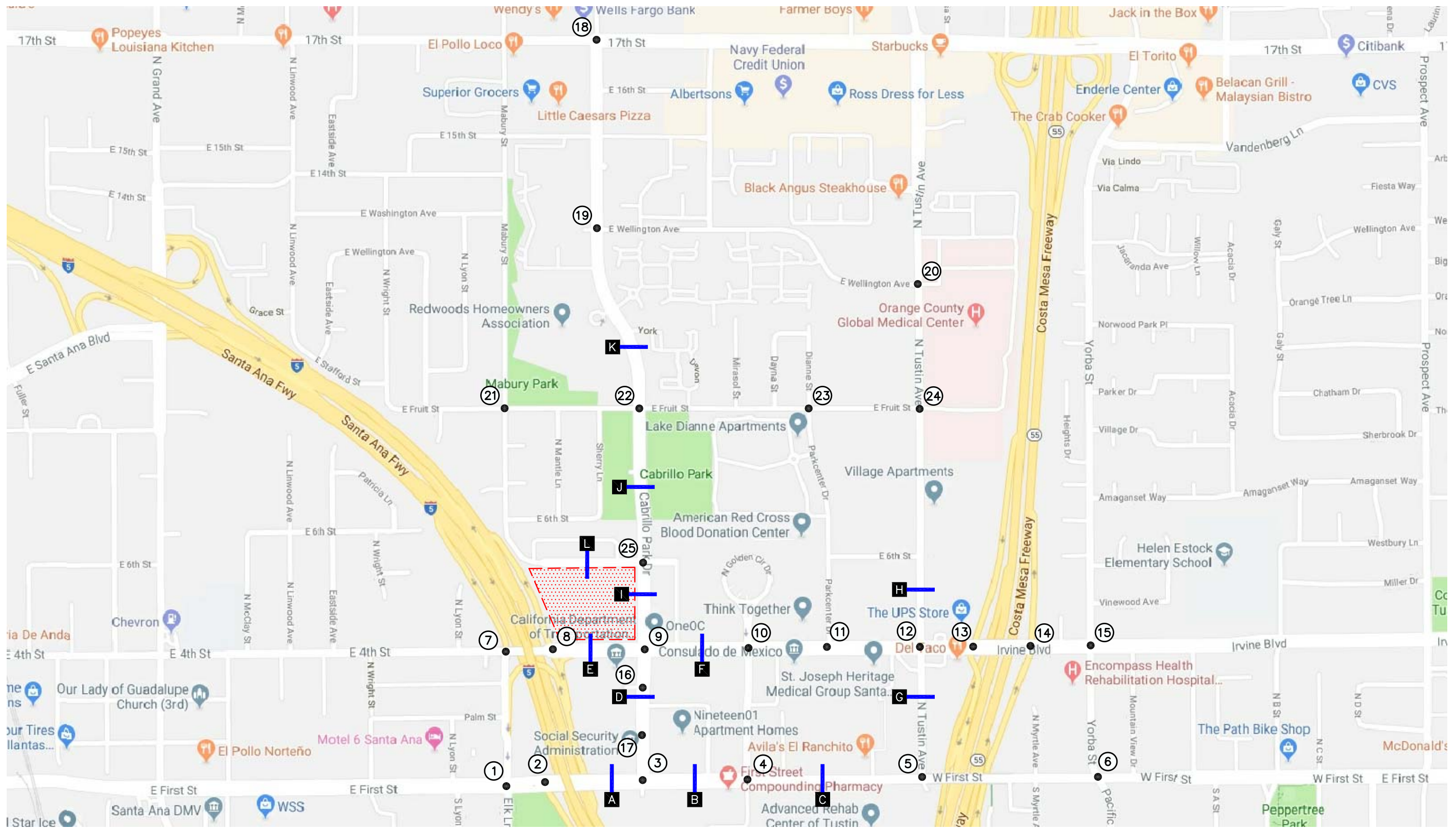
## 1.2 Study Area

Based on a “50 trip threshold” for analysis and collaboration with City staff, twenty-five (25) key study intersections have been identified for evaluation. The twenty-five (25) intersections listed below provide regional and local access to the study area and define the extent of the boundaries for this traffic impact investigation.

### Key Study Intersections

- |  |   |
|--|---|
| 1. Elk Lane at First Street (Santa Ana)  | 14. SR-55 NB Ramps at 4 <sup>th</sup> Street (Tustin/Caltrans)  |
| 2. I-5 SB On-Ramp at First Street (Santa Ana/Caltrans)                         | 15. Yorba Street at 4 <sup>th</sup> Street (Tustin)             |
| 3. Cabrillo Park Drive at First Street (Santa Ana)                             | 16. Cabrillo Park Drive at State Fund Access Road (Santa Ana)   |
| 4. Golden Circle Drive at First Street (Santa Ana)                             | 17. Cabrillo Park Drive at Xerox Center Access Road (Santa Ana) |
| 5. Tustin Avenue at First Street (Tustin)                                      | 18. Cabrillo Park Drive at 17 <sup>th</sup> Street (Santa Ana)  |
| 6. Yorba Street at First Street (Tustin)                                       | 19. Cabrillo Park Drive at Wellington Avenue (Santa Ana)        |
| 7. I-5 SB On-Ramp/Mabury Street at 4 <sup>th</sup> Street (Santa Ana/Caltrans) | 20. Tustin Avenue at Wellington Avenue (Santa Ana)              |
| 8. I-5 NB Ramps at 4 <sup>th</sup> Street (Santa Ana/Caltrans)                 | 21. Mabury Street at Fruit Street (Santa Ana)                   |
| 9. Cabrillo Park Drive at 4 <sup>th</sup> Street (Santa Ana)                   | 22. Cabrillo Park Drive at Fruit Street (Santa Ana)             |
| 10. Golden Circle Drive at 4 <sup>th</sup> Street (Santa Ana)                  | 23. Park Center Drive at Fruit Street (Santa Ana)               |
| 11. Park Center Drive at 4 <sup>th</sup> Street (Santa Ana)                    | 24. Tustin Avenue at Fruit Street (Santa Ana)                   |
| 12. Tustin Avenue at 4 <sup>th</sup> Street (Santa Ana)                        | 25. Cabrillo Park Drive at Park Court Place (Santa Ana)         |
| 13. SR-55 SB Ramps at 4 <sup>th</sup> Street (Santa Ana/Caltrans)              |   |

**Figure 1-1** presents a Vicinity Map, which illustrates the general location of the Project and depicts the study locations and surrounding street system. The Level of Service (LOS) investigations at these key locations were used to evaluate the potential traffic-related impacts associated with area growth, cumulative projects and the proposed Project. When necessary, this report recommends intersection and/or roadway improvements that may be required to accommodate future traffic volumes and restore/maintain an acceptable Level of Service, and/or mitigates the impact of the project.



n:\4100\2194141 - 4th & cabrillo mixed-use, santa ana\dwg\4141 f1-1.dwg LDP 09:24:37 08-08-2019 co



SOURCE: GOOGLE

KEY

- = STUDY INTERSECTION
- = ROADWAY SEGMENT
- = PROJECT SITE

FIGURE 1-1

VICINITY MAP

4TH AND CABRILLO MIXED-USE PROJECT, SANTA ANA

Included in this Traffic Impact Analysis are:

- Existing traffic counts,
- Estimated project traffic generation/distribution/assignment,
- Estimated cumulative project traffic generation/distribution/assignment,
- AM and PM peak hour capacity analyses for existing conditions,
- AM and PM peak hour capacity analyses for existing plus project conditions,
- AM and PM peak hour capacity analyses for future near-term (Year 2025) traffic conditions without and with the proposed Project,
- AM and PM peak hour capacity analyses for future long-term (Year 2040) traffic conditions without and with the proposed Project,
- Caltrans Analysis,
- Site Access Evaluation,
- Queueing Analysis,
- Internal Circulation and Sight Distance Evaluation,
- Recommended Intersection Improvements,
- Congestion Management Program Compliance Assessment, and

## 2.0 PROJECT DESCRIPTION

The Project site is an 8.35-acre vacant parcel of land within the Metro East Mixed Use Overlay Zone that is generally located north of 4<sup>th</sup> Street, east of the Santa Ana (I-5) freeway, and west of Cabrillo Park Drive. **Figure 2-1** is an existing aerial photograph of the Project site.

**Table 2-1** summarizes the project development totals. The proposed Project includes the development of up to 644 apartment units, 3,500 SF restaurant uses and 11,700 SF of retail space. The proposed Project will provide a total of 1,300 parking spaces within two buildings along with 18 surface parking spaces. “Building A” is proposed as a five-story apartment podium with up to 325 apartment homes consisting of approximately 19 ( $\pm 5.8\%$ ) studio units, 162 ( $\pm 49.8\%$ ) one-bedroom units, 121 ( $\pm 37.2\%$ ) two-bedroom units and 23 ( $\pm 7.1\%$ ) three-bedroom units and approximately 6,100 SF of ground floor retail/commercial space and 3,500 SF restaurant space “wrapped” around an eight-level partial subterranean parking structure with a total of approximately 650 spaces along with 9 ground floor spaces for retail/leasing. “Building B” is proposed as a five-story apartment podium with up to 319 apartment homes consisting of approximately 20 ( $\pm 6.3\%$ ) studio units, 164 ( $\pm 51.4\%$ ) one-bedroom units, 127 ( $\pm 39.8\%$ ) two-bedroom units and 8 ( $\pm 2.5\%$ ) three-bedroom units and approximately 5,600 SF of ground floor retail/commercial space “wrapped” around a eight-level partial subterranean parking structure with a total of approximately 650 spaces along with 9 ground floor spaces for retail/leasing. On-site facilities/amenities of the proposed Project include a leasing office, a lounge/lobby, business center, pool/spa, and a fitness center for residents. **Figure 2-2** presents the preferred Project site plan, prepared by KTGy.

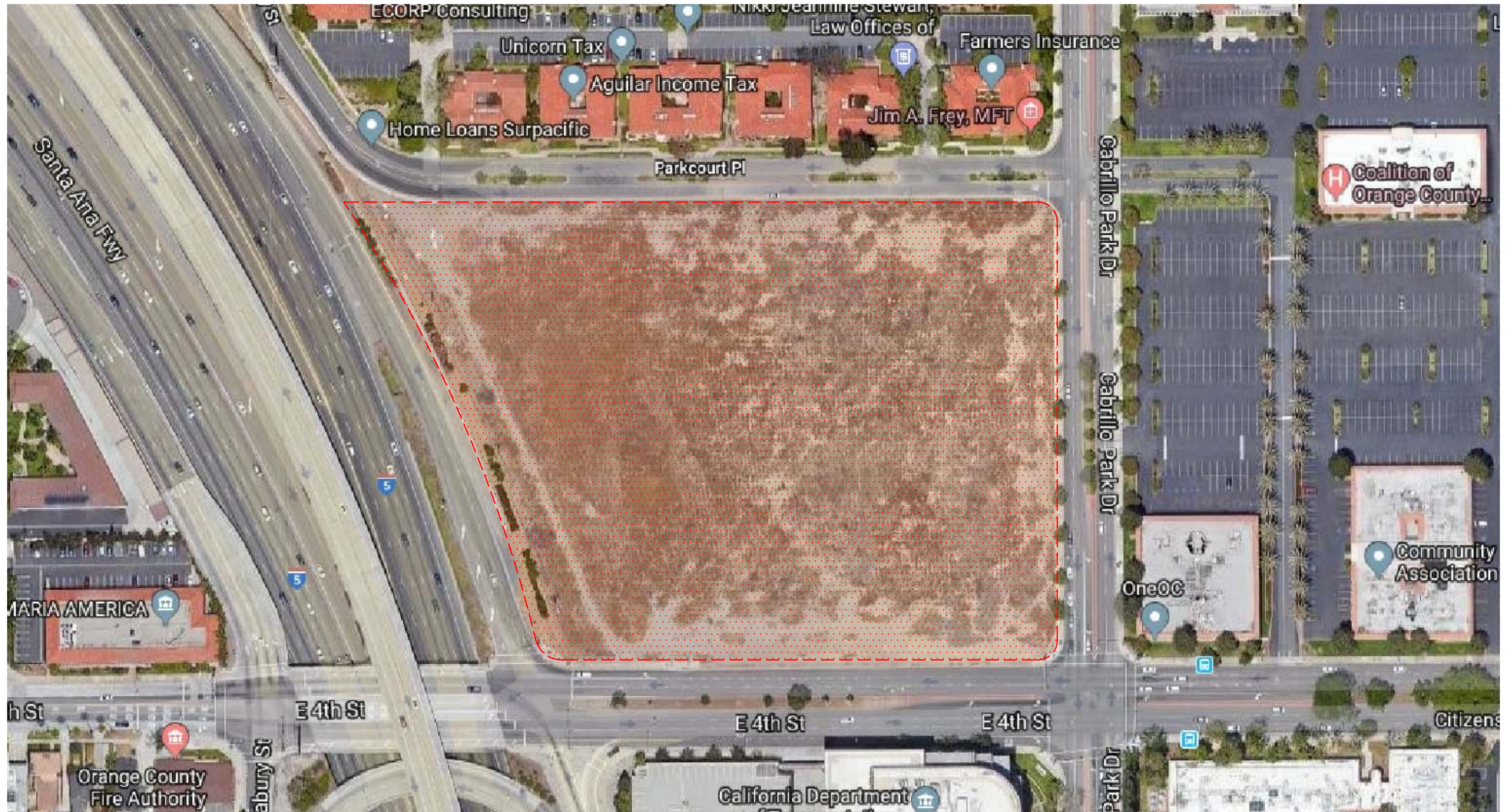
The Project is expected to be constructed and completed by Year 2025, which has been utilized to assess the Project’s potential traffic impacts at full occupancy of the project within an opening year traffic setting.

### 2.1 Site Access

Vehicular access to the proposed Project will be provided via one (1) full access unsignalized driveway along Park Court Place and one (1) right in/out only driveway located along 4<sup>th</sup> Street. As part of the proposed Project’s design features, an exclusive southbound right-turn lane will be constructed at the intersection of Cabrillo Park Drive/4<sup>th</sup> Street. Additionally, Project’s curb face is planned to be set back far enough to accommodate improvements at I-5 NB Ramps/4<sup>th</sup> Street, which include the construction of an additional right-turn lane.

### 2.2 Pedestrian Circulation

Pedestrian circulation for the proposed Project would be provided via existing public sidewalks along Park Court Place, Cabrillo Park Drive, and 4<sup>th</sup> Street within the vicinity of the Project. The existing sidewalk system within the Project vicinity provides direct connectivity to the existing development located along major thoroughfares. Pedestrian access to both the residential and retail components of the Project will be provided via building entries/exits located on Park Court Place and 4<sup>th</sup> Street.



n:\4100\2194141 - 4th & cabrillo mixed-use, santa ana\dwg\4141 f2-1.dwg LDP 10:43:1 08-08-2019 co



SOURCE: GOOGLE

KEY


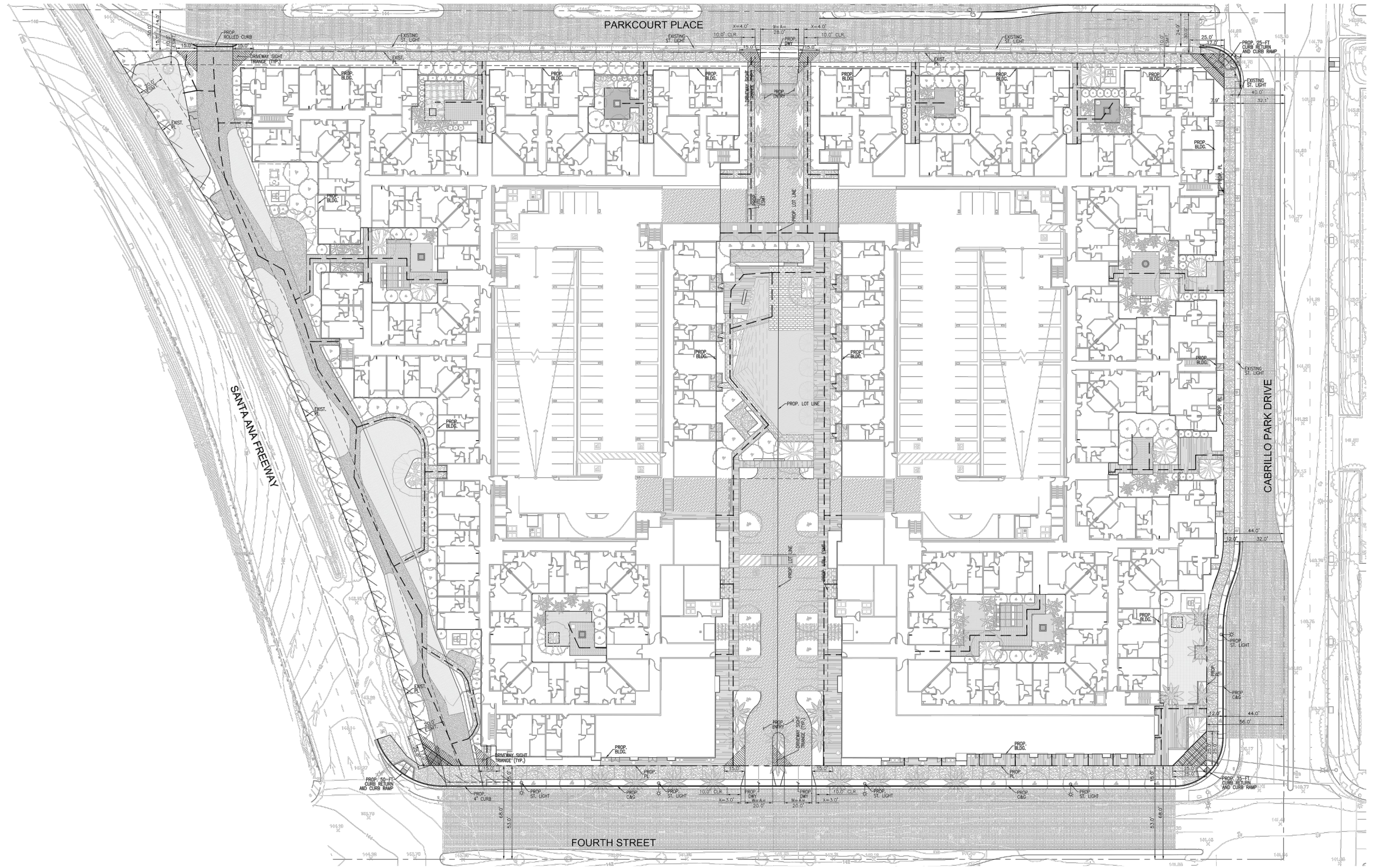
 = PROJECT SITE

FIGURE 2-1

EXISTING AERIAL SITE PLAN  
4TH AND CABRILLO MIXED-USE PROJECT, SANTA ANA





n:\41100\2194141 - 4th & cabrillo mixed-use, santa ana\dwg\4141 f2-2.dwg LDP 13:13:27 05-27-2020 aguilar

SOURCE: KTG ARCHITECTS

FIGURE 2-2

PROPOSED SITE PLAN

4TH AND CABRILLO MIXED-USE PROJECT, SANTA ANA

LINSCOTT  
LAW &  
GREENSPAN  
engineers



NO SCALE

TABLE 2-1  
PROJECT DEVELOPMENT SUMMARY

Land Use / Project Description	Project Development Totals <sup>1</sup>
<b><u>4<sup>th</sup> &amp; Cabrillo Apartments</u></b>	
<ul style="list-style-type: none"> <li>❑ Building A               <ul style="list-style-type: none"> <li>○ Studio Units</li> <li>○ 1 Bedroom Units</li> <li>○ 2 Bedroom Units</li> <li>○ 3 Bedroom Units</li> </ul> </li> <li>❑ Building B               <ul style="list-style-type: none"> <li>○ Studio Units</li> <li>○ 1 Bedroom Units</li> <li>○ 2 Bedroom Units</li> <li>○ 3 Bedroom Units</li> </ul> </li> </ul>	
	19 Units (5.8%)
	162 Units (49.8%)
	121 Units (37.2%)
	23 Units (7.1%)
	20 Units (6.3%)
	164 Units (51.4%)
	127 Units (39.8%)
	8 Units (2.5%)
<b>Total Residential Units:</b>	<b>644 Units</b>
<ul style="list-style-type: none"> <li>❑ Building A Retail</li> <li>❑ Building A Restaurant</li> <li>❑ Building B Retail</li> </ul>	6,100 SF
	3,500 SF
	<u>5,600 SF</u>
<b>Total Retail Space:</b>	<b>15,200 SF</b>
<b><u>Parking Supply</u></b>	
<ul style="list-style-type: none"> <li>❑ Parking Structure               <ul style="list-style-type: none"> <li>○ Building A</li> <li>○ Building B</li> </ul> </li> <li>❑ Surface Parking Lot               <ul style="list-style-type: none"> <li>○ Retail/Leasing</li> </ul> </li> </ul>	
	650 spaces
	650 spaces
	<u>18 spaces</u>
<b>Total Parking Supply:</b>	<b>1,318 spaces</b>

<sup>1</sup> Source: Conceptual Site Plan, prepared by KTGy, dated February 28, 2020.

## 3.0 EXISTING CONDITIONS

### 3.1 Existing Street System

The principal local network of streets serving the project site is First Street, 4<sup>th</sup> Street, 17<sup>th</sup> Street, Park Court Place, Cabrillo Park Drive, and Tustin Avenue. The following discussion provides a brief synopsis of these key area streets. The descriptions are based on an inventory of existing roadway conditions.

**First Street** a four to six-lane, divided roadway in the vicinity of the project, oriented in the east-west direction that provides two or three lanes in each direction separated by a raised median island. The posted speed limit on First Street is 35 mph. On-street parking is not permitted along this roadway. A traffic signal controls the study intersections of First Street at Mabury Street/Elk Lane, I-5 SB On Ramp, Cabrillo Park Drive, Golden Center Drive, Tustin Avenue, and Yorba Street.

**4<sup>th</sup> Street** is a six-lane, divided roadway oriented in the east-west direction that provides three eastbound and three westbound travel lanes separated by a raised median island. The posted speed limit on Fourth Street is 40 miles per hour (mph). On-street parking is not permitted along this roadway in the vicinity of the project. Traffic signals control the study intersections of Fourth Street at I-5 SB Off-Ramp, I-5 NB On-Ramp, Cabrillo Park Drive, Golden Circle Drive, Park Center Drive, Tustin Avenue, SR-55 SB Ramps, SR-55 NB Ramps and Yorba Street. East of the SR-55 Freeway, Fourth Street is known as Irvine Boulevard within the City of Tustin.

**17<sup>th</sup> Street** is a six-lane, divided roadway oriented in the east-west direction. The posted speed limit on 17<sup>th</sup> Street is 40 mph. On-street parking is not permitted on either side of this roadway in the vicinity of the Project. A traffic signal controls the study intersection of 17<sup>th</sup> Street at Cabrillo Park Drive.

**Park Court Place** is a two-lane, divided roadway oriented in the east-west direction. The posted speed limit on Park Court Place is 25 mph. On-street parking is not permitted on either side of this roadway in the vicinity of the Project.

**Cabrillo Park Drive** is a four-lane, divided roadway that borders the project site to the east, oriented in the north-south direction. The posted speed limit on Cabrillo Park Drive is 35 mph. On-street parking is not permitted along this roadway in the vicinity of the project. Traffic signals control the study intersections of Fourth Street, State Fund Access Road, Xerox Centre Access Road, and First Street.

**Tustin Avenue** is a six-lane, divided roadway, oriented in the north-south direction. On-street parking is not permitted along this roadway in the vicinity of the project. The posted speed limit on Tustin Avenue is 40 mph. Traffic signals control the study intersections of Tustin at Fourth Street, First Street, Wellington Avenue, and Fruit Street.

**Figure 3-1** presents an inventory of the existing roadway conditions for the arterials and intersections evaluated in this report. This figure identifies the number of travel lanes for key arterials, as well as intersection configurations and controls for the key area study intersections.

### 3.1.1 Public Transit

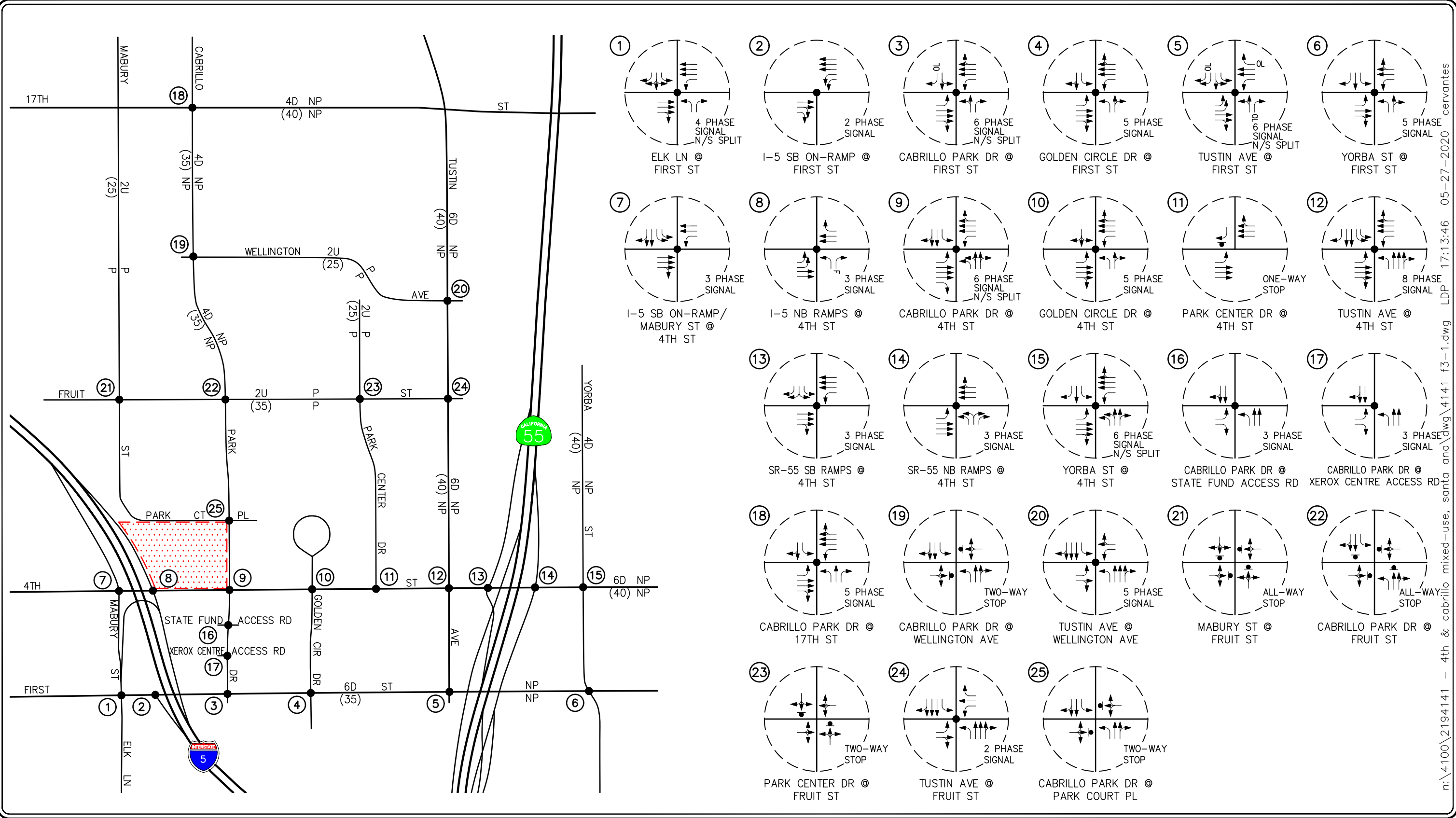
Public transit bus service is provided in the project area by the Orange County Transportation Authority (OCTA). Four (4) OCTA bus routes operate within the vicinity of the project site on First Street, 4<sup>th</sup> Street, 17<sup>th</sup> Street, and Tustin Avenue, which consists of the following:

- OCTA Route 60: The major routes of travel include 17<sup>th</sup> Street and Tustin Avenue. Nearest to the project site are bus stops located on 17<sup>th</sup> Street at Cabrillo Park Drive in the northwest and southwest corners. Route 60 operates on approximate 30-minute headways during weekdays and 20-minute headways on weekends.
- OCTA Route 64: The major route of travel is First Street. Nearest to the project site are bus stops located on First Street at Cabrillo Park Drive in the southeast and northeast corners. Route 64 operates on approximate 30-minute headways on the weekdays and 20-minutes on the weekends.
- OCTA Route 71: The major route of travel is Tustin Avenue. Nearest to the project site are bus stops located on Tustin Avenue at 4<sup>th</sup> Street in the northeast and southwest corners. Route 71 operates on approximate 30-minute headways on the weekdays and 45-minute headways on the weekends.
- OCTA Route 463: The major route of travel is 4<sup>th</sup> Street. Nearest to the project site are bus stops located on 4<sup>th</sup> Street at Cabrillo Park Drive in the northeast and southeast corners. Route 463 operates on approximate 25-minute headways on the weekdays and no bus service on the weekends.

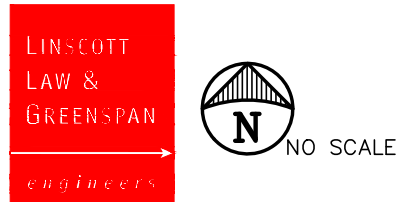
**Figure 3-2** graphically illustrates the transit routes of OCTA within the vicinity of the project. **Figure 3-3** identifies the locations of the existing bus stops in proximity to the Project site.

### 3.2 Bicycle Master Plan

The City of Santa Ana promotes bicycling as a means of mobility and a way in which to improve the quality of life within its community. The Bikeway Master Plan recognizes the needs of bicycle users and aims to create a complete and safe bicycle network throughout the City. Currently, not many bicycle facilities exist in the study area. However, review of **Figure 3-4**, which presents the City's Bikeway Master Plan, shows that a Class I bike path is proposed to be built along Tustin Avenue within the vicinity of the Project.



n:\4100\2194141 - 4th & cabrillo mixed-use, santa ana\dwg\4141 f3-1.dwg LDP 17:13:46 05-27-2020 cervantes

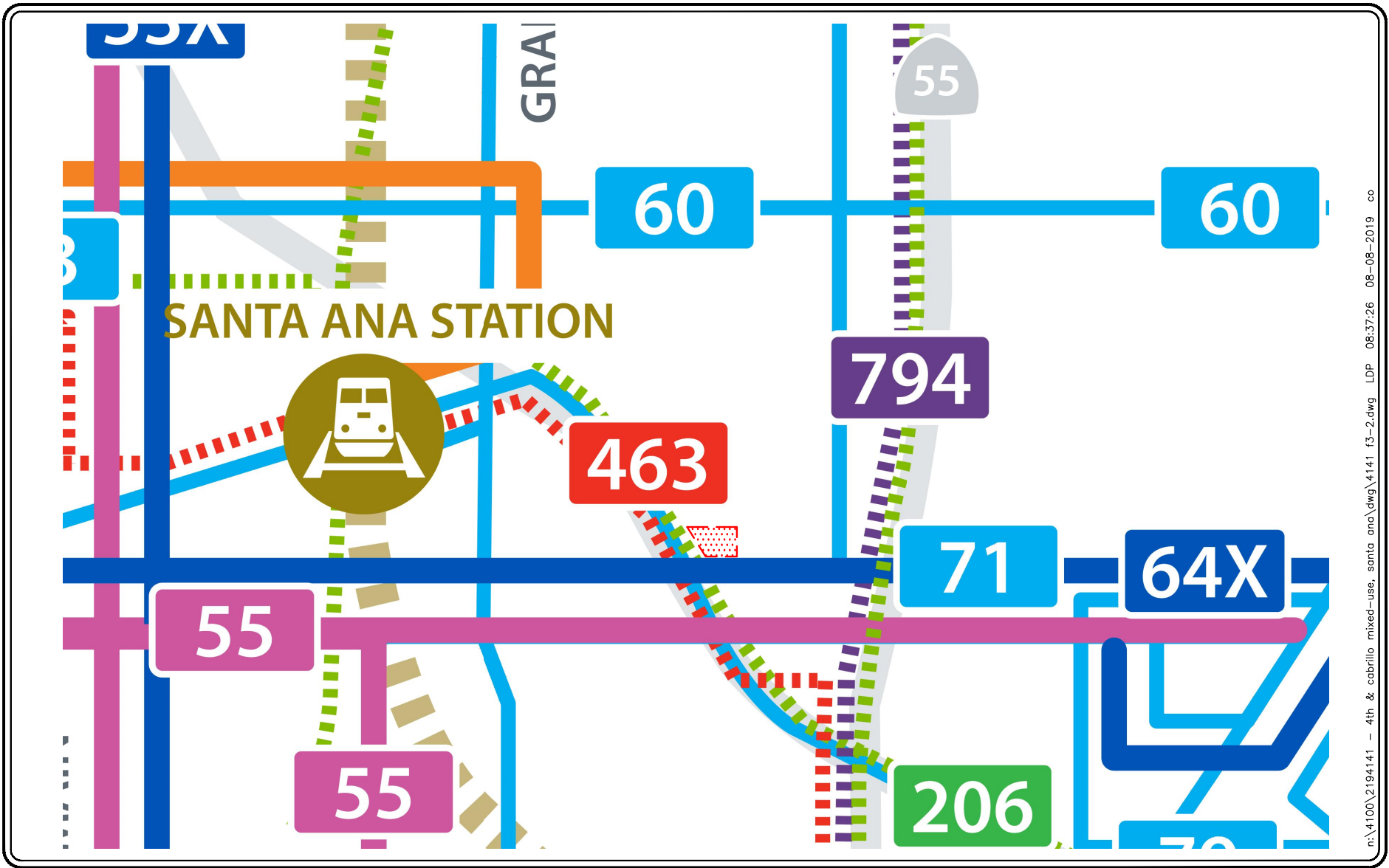


- KEY**
- ← = APPROACH LANE ASSIGNMENT
  - = TRAFFIC SIGNAL, ▽ = STOP SIGN
  - P = PARKING, NP = NO PARKING
  - U = UNDIVIDED, D = DIVIDED
  - 2 = NUMBER OF TRAVEL LANES
  - (XX) = POSTED SPEED LIMIT (MPH)
  - F = FREE-RIGHT, OL = OVERLAP
  - ▨ = PROJECT SITE

**FIGURE 3-1**

**EXISTING ROADWAY CONDITIONS AND INTERSECTION CONTROLS**

4TH AND CABRILLO MIXED-USE PROJECT, SANTA ANA



n:\4100\2194141 - 4th & cabrillo mixed-use, santa ana\dwg\4141 f3-2.dwg LDP 08:37:26 08-08-2019 co

LINSCOTT  
LAW &  
GREENSPAN  
engineers

NO SCALE

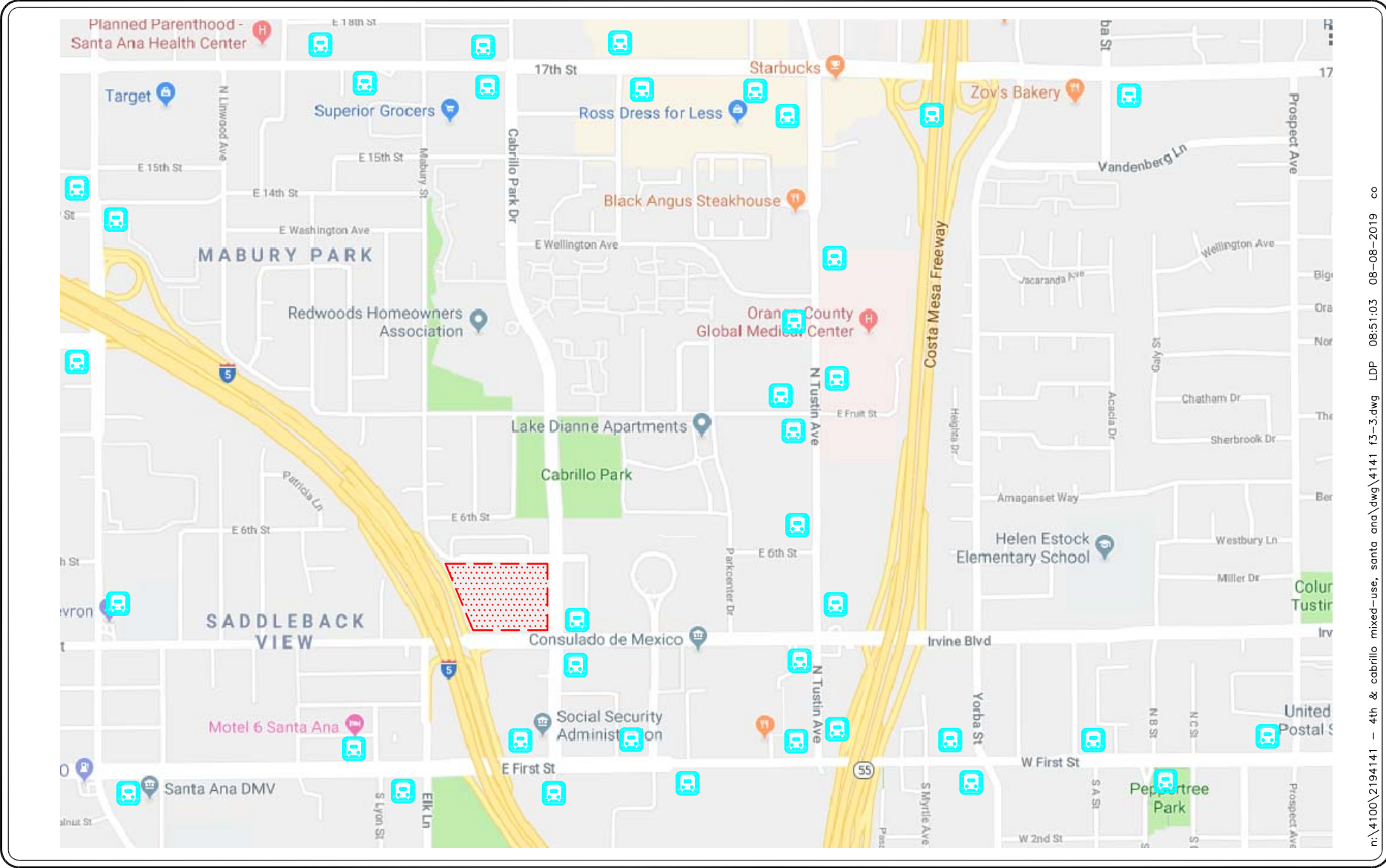
SOURCE: OCTA

KEY

= PROJECT SITE

FIGURE 3-2

OCTA TRANSIT MAP  
4TH AND CABRILLO MIXED-USE PROJECT, SANTA ANA





n:\4100\2194141 - 4th & cabrillo mixed-use, santa ana\dwg\4141 f3-3.dwg LDP 08:51:03 08-08-2019 co



SOURCE: GOOGLE

**KEY**

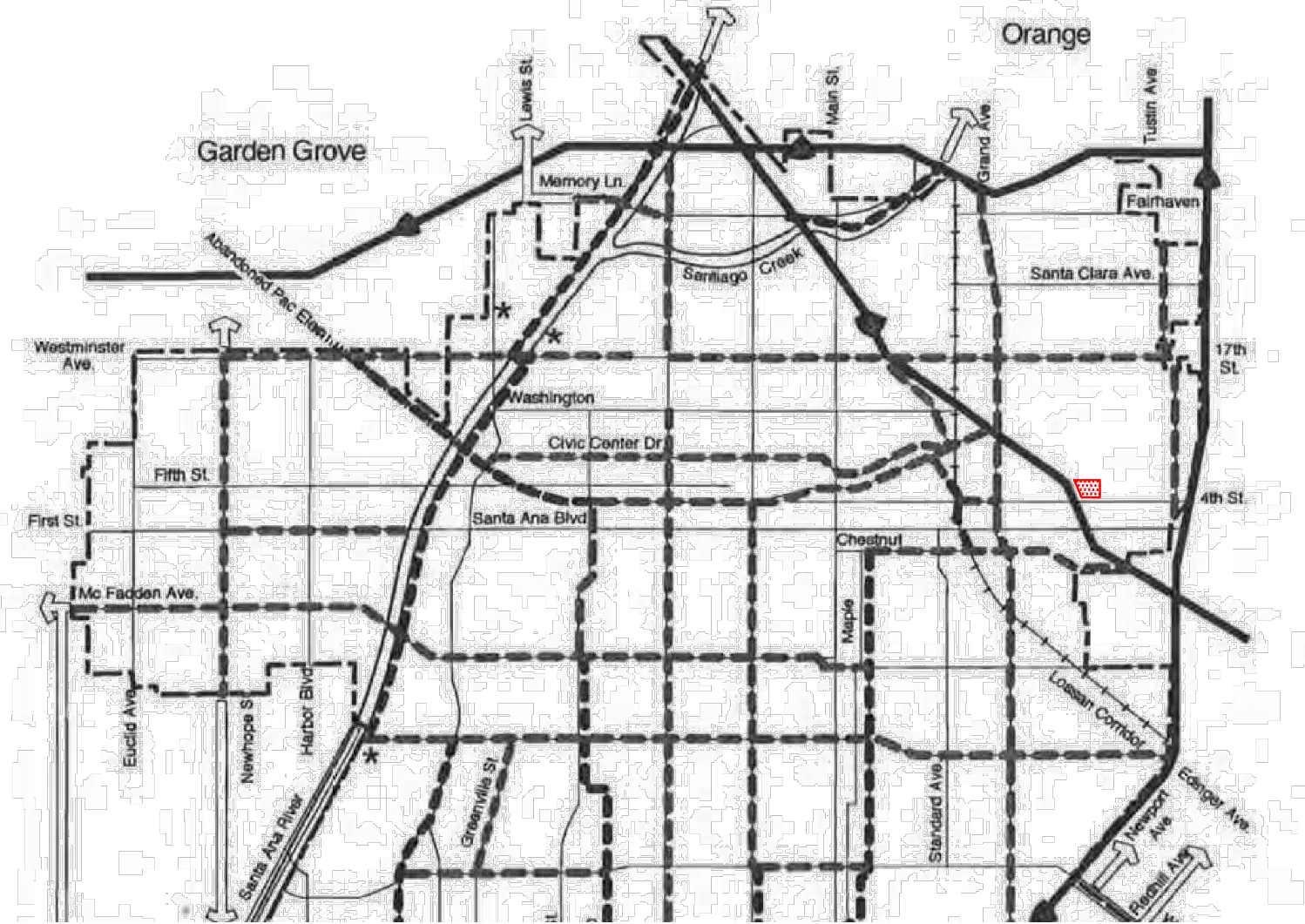
-  = PROJECT SITE
-  = TRANSIT STOP

# FIGURE 3-3

## TRANSIT STOP LOCATIONS

4TH AND CABRILLO MIXED-USE PROJECT, SANTA ANA

# Exhibit 2 Bikeway Master Plan



n:\4100\2194141 - 4th & cabrillo mixed-use, santa ana\dwg\4141 f3-4.dwg LDP 08:53:18 08-08-2019 co


SOURCE: CITY OF SANTA ANA GENERAL PLAN

## FIGURE 3-4

### KEY

 = PROJECT SITE

LINSCOTT  
LAW &  
GREENSPAN  
engineers



CITY OF SANTA ANA BIKEWAY MASTER PLAN  
4TH AND CABRILLO MIXED-USE PROJECT, SANTA ANA



### 3.3 Existing Traffic Volumes

Twenty-five (25) key study intersections have been identified as the locations at which to evaluate existing and future traffic operating conditions. Some portion of potential project-related traffic will pass through each of these intersections, and their analysis will reveal the expected relative impacts of the project. These key locations were selected for evaluation based on discussions with City of Santa Ana staff and in consideration of Orange County CMP requirements.

Existing daily, AM peak hour and PM peak hour traffic volumes for the twenty-five (25) key study intersections evaluated in this report were obtained from manual turning movement counts conducted by National Data and Surveying Services in May 2019.

**Figures 3-5** and **3-6** illustrate the existing AM and PM peak hour traffic volumes at the twenty-five (25) key study intersections evaluated in this report, respectively. **Figure 3-6** also presents the existing average daily traffic volumes for twelve (12) key roadway segments in the vicinity of the proposed Project. **Appendix B** contains the detailed peak hour and daily traffic count sheets for the key intersections and roadway segments evaluated in this report.

### 3.4 Existing Intersection Conditions

Existing AM and PM peak hour operating conditions for the twenty-five (25) key study intersections were evaluated using the *Intersection Capacity Utilization (ICU)* methodology for signalized intersections and the methodology outlined in the *Highway Capacity Manual 6 (HCM 6)* for unsignalized intersections.

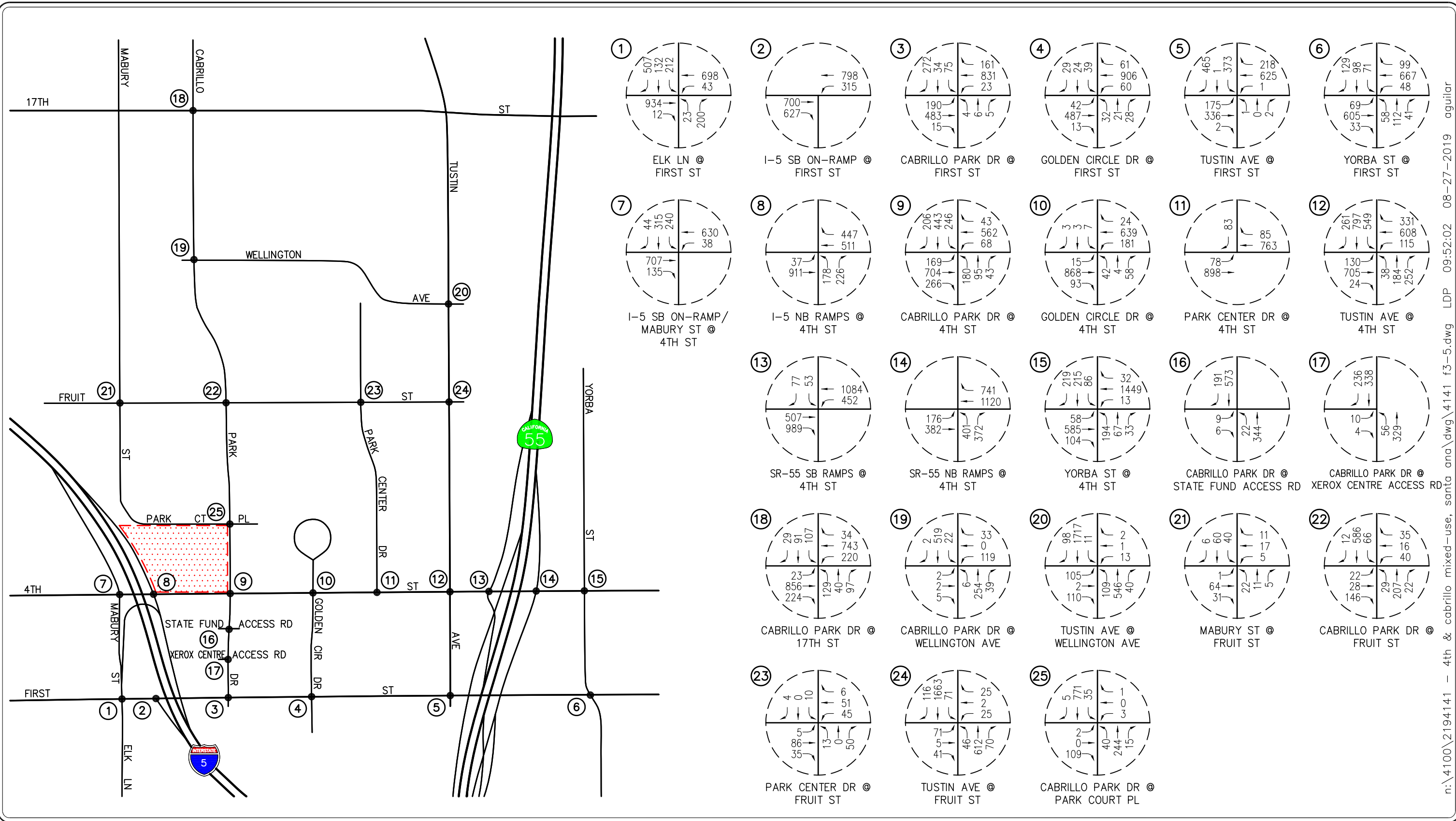
#### 3.4.1 *Intersection Capacity Utilization (ICU) Method of Analysis*

In conformance with Cities of Santa Ana, Tustin and Orange County CMP requirements, existing AM and PM peak hour operating conditions for the key signalized study intersections were evaluated using the Intersection Capacity Utilization (ICU) method. The ICU technique is intended for signalized intersection analysis and estimates the volume to capacity (V/C) relationship for an intersection based on the individual V/C ratios for key conflicting traffic movements. The ICU numerical value represents the percent signal (green) time, and thus capacity, required by existing and/or future traffic. It should be noted that the ICU methodology assumes uniform traffic distribution per intersection approach lane and optimal signal timing.

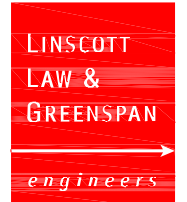
Per City of Santa Ana requirements, the ICU calculations use a lane capacity of 1,700 vehicles per hour (vph) for through lanes and 1,600 vph for left-turn lanes and right-turn lanes. A clearance adjustment factor of 0.05 was added to each Level of Service calculation.

Per City of Tustin requirements, the ICU calculations use a lane capacity of 1,700 for through and all turn lanes. A clearance adjustment factor of 0.05 was added to each Level of Service calculation.

The ICU value translates to a Level of Service (LOS) estimate, which is a relative measure of the intersection performance. The ICU value is the sum of the critical volume to capacity ratios at an intersection; it is not intended to be indicative of the LOS of each of the individual turning



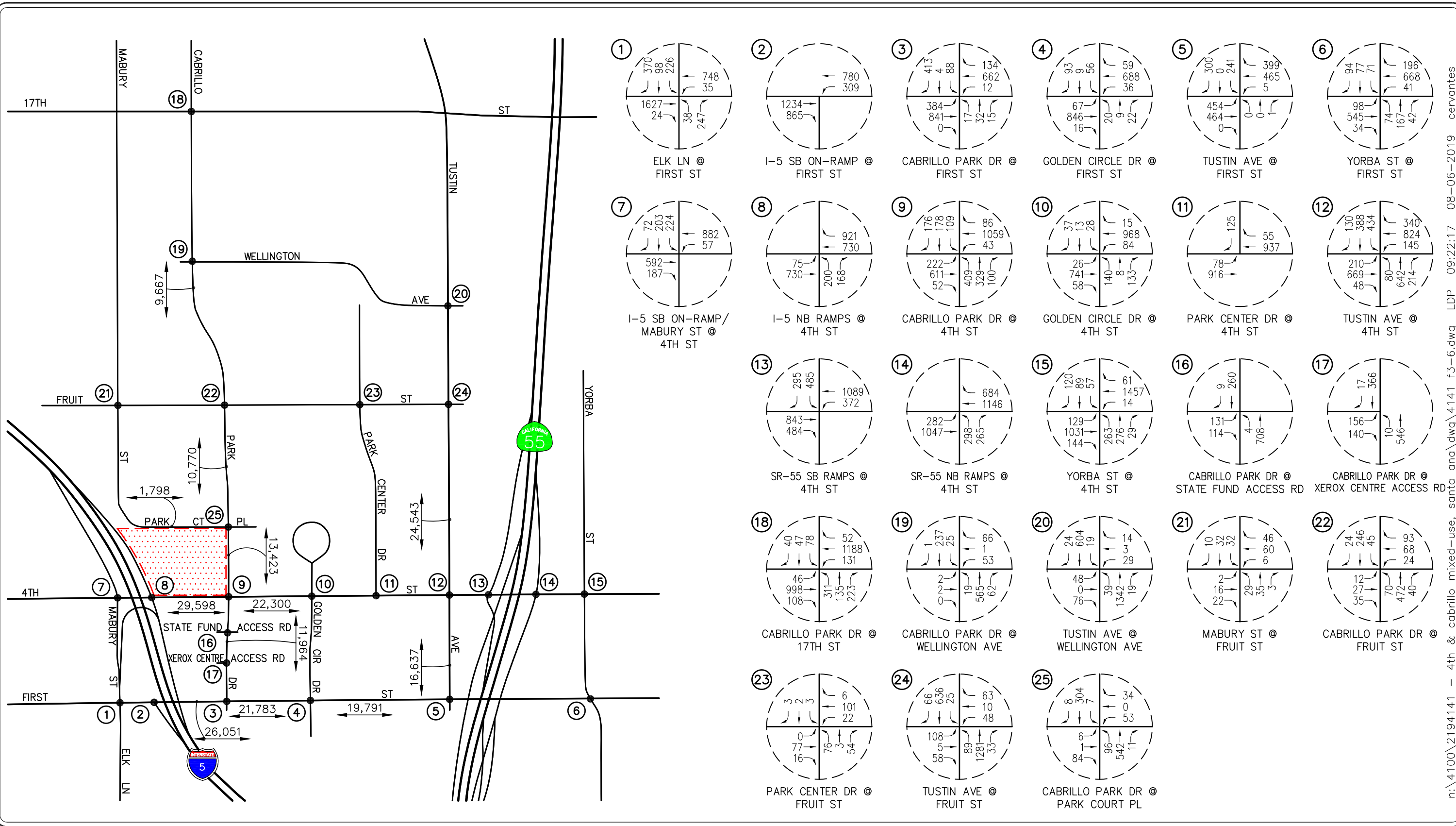
n:\4100\2194141 - 4th & cabrillo mixed-use, santa ana\dwg\4141 f3-5.dwg LDP 09:52:02 08-27-2019 aguilar



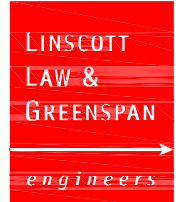
**KEY**  
 # = STUDY INTERSECTION  
 [Red Dotted Box] = PROJECT SITE

**FIGURE 3-5**

**EXISTING AM PEAK HOUR TRAFFIC VOLUMES**  
 4TH AND CABRILLO MIXED-USE PROJECT, SANTA ANA



n:\4100\2194141 - 4th & cabrillo mixed-use, santa ana\dwg\4141 f3-6.dwg LDP 09:22:17 08-06-2019 cervantes



**KEY**

- ⊙ = STUDY INTERSECTION
- XX,XXX = STUDY ROADWAY SEGMENT
- ▨ = PROJECT SITE

**FIGURE 3-6**

**EXISTING PM PEAK HOUR AND DAILY TRAFFIC VOLUMES**  
4TH AND CABRILLO MIXED-USE PROJECT, SANTA ANA

movements. The six qualitative categories of Level of Service have been defined along with the corresponding ICU value range and are shown in **Table 3-1**.

### 3.4.2 Highway Capacity Manual 6 (HCM 6) Method of Analysis (Unsignalized Intersections)

Two-way stop-controlled intersections are comprised of a major street, which is uncontrolled, and a minor street, which is controlled by stop signs. Level of service for a two-way stop-controlled intersection is determined by the computed or measured control delay. The control delay by movement, by approach, and for the intersection as a whole is estimated by the computed capacity for each movement. LOS is determined for each minor-street movement (or shared movement) as well as major-street left turns. The worst side street approach delay is reported. LOS is not defined for the intersection as a whole or for major-street approaches, as it is assumed that major-street through vehicles experience zero delay. The HCM control delay value range for two-way stop-controlled intersections is shown in **Table 3-2**.

TABLE 3-1  
LEVEL OF SERVICE CRITERIA FOR SIGNALIZED INTERSECTIONS (ICU METHODOLOGY)

Level of Service (LOS)	Intersection Capacity Utilization Value (V/C)	Level of Service Description
A	$\leq 0.60$	EXCELLENT. No vehicle waits longer than one red light, and no approach phase is fully used.
B	0.61 – 0.70	VERY GOOD. An occasional approach phase is fully utilized; many drivers begin to feel somewhat restricted within groups of vehicles.
C	0.71 – 0.80	GOOD. Occasionally drivers may have to wait through more than one red light; backups may develop behind turning vehicles.
D	0.81 – 0.90	FAIR. Delays may be substantial during portions of the rush hours, but enough lower volume periods occur to permit clearing of developing lines, preventing excessive backups.
E	0.91 – 1.00	POOR. Represents the most vehicles intersection approaches can accommodate; may be long lines of waiting vehicles through several signal cycles.
F	$> 1.00$	FAILURE. Backups from nearby locations or on cross streets may restrict or prevent movement of vehicles out of the intersection approaches. Potentially very long delays with continuously increasing queue lengths.

TABLE 3-2  
LEVEL OF SERVICE CRITERIA FOR UNSIGNALIZED INTERSECTIONS (HCM 6 METHODOLOGY)<sup>2</sup>

Level of Service (LOS)	Highway Capacity Manual (HCM) Delay Per Vehicle (seconds/vehicle)	Level of Service Description
A	$\leq 10.0$	Little or no delay
B	$> 10.0$ and $\leq 15.0$	Short traffic delays
C	$> 15.0$ and $\leq 25.0$	Average traffic delays
D	$> 25.0$ and $\leq 35.0$	Long traffic delays
E	$> 35.0$ and $\leq 50.0$	Very long traffic delays
F	$> 50.0$	Severe congestion

<sup>2</sup> Source: *Highway Capacity Manual 6*, Chapter 20: Two-Way Stop-Controlled Intersections. The LOS criteria apply to each lane on a given approach and to each approach on the minor street. LOS is not calculated for major-street approaches or for the intersection as a whole.

### 3.4.3 Level of Service Criteria

According to the Cities of Santa Ana and Tustin, LOS D is the minimum acceptable condition that should be maintained during the peak commute hours. However, the City of Santa Ana has defined exceptions to this criterion at specific locations within the study area. The City of Santa Ana has defined major development areas where LOS “E” is considered acceptable.

Based on the above, the following summarizes the LOS required for each key study intersection:

➤ **LOS “D” Requirements:**

- |   |  |
|---|--|
| 1. Elk Lane at First Street                               | 15. Yorba Street at 4 <sup>th</sup> Street         |
| 2. I-5 SB On-Ramp at First Street                         | 18. Cabrillo Park Drive at 17 <sup>th</sup> Street |
| 5. Tustin Avenue at First Street                          | 19. Cabrillo Park Drive at Wellington Avenue       |
| 6. Yorba Street at First Street                           | 21. Mabury Street at Fruit Street                  |
| 7. I-5 SB On-Ramp/Mabury Street at 4 <sup>th</sup> Street | 22. Cabrillo Park Drive at Fruit Street            |
| 8. I-5 NB Ramps at 4 <sup>th</sup> Street                 | 23. Park Center Drive at Fruit Street              |
| 13. SR-55 SB Ramps at 4 <sup>th</sup> Street              | 25. Cabrillo Park Drive at Park Court Place        |
| 14. SR-55 NB Ramps at 4 <sup>th</sup> Street              |  |

➤ **LOS “E” Requirements:**

- |   |   |
|---|---|
| 3. Cabrillo Park Drive at First Street            | 12. Tustin Avenue at 4 <sup>th</sup> Street         |
| 4. Golden Circle Drive at First Street            | 16. Cabrillo Park Drive at State Fund Access Road   |
| 9. Cabrillo Park Drive at 4 <sup>th</sup> Street  | 17. Cabrillo Park Drive at Xerox Center Access Road |
| 10. Golden Circle Drive at 4 <sup>th</sup> Street | 20. Tustin Avenue at Wellington Avenue              |
| 11. Park Center Drive at 4 <sup>th</sup> Street   | 24. Tustin Avenue at Fruit Street                   |

### 3.5 Existing Level of Service Results

**Table 3-3** summarizes the existing peak hour service level calculations for the twenty-five (25) key study intersections based on existing traffic volumes and current street geometrics. Review of **Table 3-3** indicates that twenty-four (24) of the twenty-five key study intersections currently operate at an acceptable level of service during the AM and PM peak hours. The intersection of SR-55 SB Ramps/4<sup>th</sup> Street currently operates at unacceptable LOS E during the AM peak hour.

**Appendix D** presents the ICU/LOS and HCM/LOS calculation worksheets for the twenty-five (25) key study intersections for the AM peak hour and PM peak hour.

TABLE 3-3  
EXISTING PEAK HOUR INTERSECTION CAPACITY ANALYSIS

Key Intersection		Jurisdiction	Minimum Acceptable LOS	Control Type	Time Period	ICU/HCM	LOS
1.	Elk Lane at First Street	Santa Ana	D	4Ø Traffic Signal	AM	0.599	A
					PM	0.716	C
2.	I-5 SB On Ramp at First Street	Santa Ana/ Caltrans	D	2Ø Traffic Signal	AM	0.599	A
					PM	0.716	C
3.	Cabrillo Park Drive at First Street	Santa Ana	E	6Ø Traffic Signal	AM	0.425	A
					PM	0.584	A
4.	Golden Circle Drive at First Street	Santa Ana	E	5Ø Traffic Signal	AM	0.450	A
					PM	0.544	A
5.	Tustin Avenue at First Street	Tustin	D	6Ø Traffic Signal	AM	0.331	A
					PM	0.324	A
6.	Yorba Street at First Street	Tustin	D	5Ø Traffic Signal	AM	0.396	A
					PM	0.418	A
7.	I-5 SB On Ramp/Mabury Street at 4 <sup>th</sup> street	Santa Ana/ Caltrans	D	3Ø Traffic Signal	AM	0.448	A
					PM	0.526	A
8.	I-5 NB Ramps at 4 <sup>th</sup> Street	Santa Ana/ Caltrans	D	3Ø Traffic Signal	AM	0.357	A
					PM	0.395	A
9.	Cabrillo Park Drive at 4 <sup>th</sup> Street	Santa Ana	E	6Ø Traffic Signal	AM	0.429	A
					PM	0.774	C
10.	Golden Circle Drive at 4 <sup>th</sup> Street	Santa Ana	E	5Ø Traffic Signal	AM	0.398	A
					PM	0.405	A
11.	Park Center Drive at 4 <sup>th</sup> Street	Santa Ana	E	One-Way Stop	AM	13.7 s/v	B
					PM	16.2 s/v	C
12.	Tustin Avenue at 4 <sup>th</sup> Street	Santa Ana	E	8Ø Traffic Signal	AM	0.667	B
					PM	0.738	C
13.	SR-55 SB Ramps at 4 <sup>th</sup> Street	Santa Ana/ Caltrans	D	3Ø Traffic Signal	AM	<b>0.978</b>	<b>E</b>
					PM	0.748	C
14.	SR-55 NB Ramps at 4 <sup>th</sup> Street	Tustin/ Caltrans	D	3Ø Traffic Signal	AM	0.670	B
					PM	0.689	B
15.	Yorba Street at 4 <sup>th</sup> Street	Tustin	D	6Ø Traffic Signal	AM	0.561	A
					PM	0.605	B



TABLE 3-3 (CONTINUED)  
EXISTING PEAK HOUR INTERSECTION CAPACITY ANALYSIS

Key Intersection		Jurisdiction	Minimum Acceptable LOS	Control Type	Time Period	ICU/HCM	LOS
16.	Cabrillo Park Drive at State Fund Access Road	Santa Ana	E	3Ø Traffic Signal	AM	0.308	A
					PM	0.340	A
17.	Cabrillo Park Drive at Xerox Centre Access Road	Santa Ana	E	3Ø Traffic Signal	AM	0.271	A
					PM	0.308	A
18.	Cabrillo Park Drive at 17 <sup>th</sup> Street	Santa Ana	D	5Ø Traffic Signal	AM	0.568	A
					PM	0.611	B
19.	Cabrillo Park Drive at Wellington Avenue	Santa Ana	D	Two-Way Stop	AM	17.8 s/v	C
					PM	17.9 s/v	C
20.	Tustin Avenue at Wellington Avenue	Santa Ana	E	5Ø Traffic Signal	AM	0.574	A
					PM	0.411	A
21.	Mabury Street at Fruit Street	Santa Ana	D	All-Way Stop	AM	7.7 s/v	A
					PM	7.7 s/v	A
22.	Cabrillo Park Drive at Fruit Street	Santa Ana	D	All-Way Stop	AM	12.5 s/v	B
					PM	11.5 s/v	B
23.	Park Center Drive at Fruit Street	Santa Ana	D	Two-Way Stop	AM	10.3 s/v	B
					PM	10.5 s/v	B
24.	Tustin Avenue at Fruit Street	Santa Ana	E	2Ø Traffic Signal	AM	0.509	A
					PM	0.446	A
25.	Cabrillo Park Drive at Park Court Place	Santa Ana	D	Two-Way Stop	AM	18.6 s/v	C
					PM	24.3 s/v	C

## 4.0 TRAFFIC FORECASTING METHODOLOGY

In order to estimate the traffic impact characteristics of the proposed Project, a multi-step process has been utilized. The first step is traffic generation, which estimates the total arriving and departing traffic on a peak hour and daily basis. The traffic generation potential is forecast by applying the appropriate vehicle trip generation equations or rates to the project development tabulation.

The second step of the forecasting process is traffic distribution, which identifies the origins and destinations of inbound and outbound project traffic. These origins and destinations are typically based on demographics and existing/expected future travel patterns in the study area.

The third step is traffic assignment, which involves the allocation of project traffic to study area streets and intersections. Traffic assignment is typically based on minimization of travel time, which may or may not involve the shortest route, depending on prevailing operating conditions and travel speeds. Traffic distribution patterns are indicated by general percentage orientation, while traffic assignment allocates specific volume forecasts to individual roadway links and intersection turning movements throughout the study area.

With the forecasting process complete and project traffic assignments developed, the impact of the proposed project is isolated by comparing operational (LOS) conditions at selected key intersections using expected future traffic volumes with and without forecast project traffic. The need for site-specific and/or cumulative local area traffic improvements can then be evaluated and the significance of the project's impacts identified.

## 5.0 PROJECT TRAFFIC CHARACTERISTICS

### 5.1 Project Traffic Generation

Traffic generation is expressed in vehicle trip ends, defined as one-way vehicular movements, either entering or exiting the generating land use. Generation equations and/or rates used in the traffic forecasting procedure are found in the 10<sup>th</sup> Edition of *Trip Generation*, published by the Institute of Transportation Engineers (ITE) [Washington D.C., 2017].

**Table 5-1** summarizes the trip generation rates used in forecasting the vehicular trips generated by the proposed Project and presents the project's forecast peak hour and daily traffic volumes. As shown in the upper portion of **Table 5-1**, ITE Land Use 221: Multifamily Housing (Mid-Rise), ITE Land Use 820: Shopping Center, and ITE Land Use 932: High Turnover Sit-Down Restaurant trip rates were used to forecast the trip generation potential for the proposed project.

A review of the lower portion of this table indicates that the proposed Project, after adjustment for internal capture, is forecast to generate approximately 4,121 “net” daily trips, with 264 “net” trips (82 inbound, 182 outbound) produced in the AM peak hour and 344 “net” trips (205 inbound, 139 outbound) produced in the PM peak hour on a “typical” weekday.

### 5.2 Project Traffic Distribution and Assignment

**Figure 5-1** presents the traffic distribution pattern for the proposed Project. A tabular summary of the general directional Project trip distribution pattern is presented **Table 5-2**. Project traffic volumes both entering and exiting the project site have been distributed and assigned to the adjacent street system based on the following considerations:

- location of site access points in relation to the surrounding street system,
- the site's proximity to major traffic carriers and regional access routes,
- physical characteristics of the circulation system such as lane channelization and presence of traffic signals that affect travel patterns,
- presence of traffic congestion in the surrounding vicinity,
- ingress/egress availability at the project site (i.e. right-turn restrictions on 4<sup>th</sup> Street access and full access on Park Court Place driveway),
- distribution patterns contained within the *Traffic Impact Study for the Metro East Overlay Zone in the City of Santa Ana*, and
- input from City staff.

The anticipated AM and PM peak hour project traffic volumes associated with the proposed Project are presented in **Figures 5-2** and **5-3**, respectively. **Figure 5-3** also presents the daily Project traffic volumes. The traffic volume assignments presented in **Figures 5-2** and **5-3** reflect the traffic distribution characteristics shown in **Figure 5-1** and the traffic generation forecast presented in **Table 5-1**.

It should be noted that travel patterns are generally focused to major streets with larger roadway classifications and typically higher travel speeds. As such, it is forecast that the majority of project-related traffic will utilize 4<sup>th</sup> Street and Cabrillo Park Drive to Park Court Place to access the Project site, with Project traffic travelling to and from the north via Mabury Street for to be minimal when accessing the Project site. Based on *Table 5-1* and *Figure 5-1*, it is anticipated that approximately 4% of Project traffic will utilize Mabury Street which translates to approximately 1 cars every 8 minutes and 1 car every 4 minutes in the AM and PM peak hours, respectively. This added volume to the local residential network is considered nominal and would have little to no effect on the overall existing traffic patterns or operating conditions.

### 5.3 Existing Plus Project Traffic Conditions

The Existing Plus Project traffic conditions have been generated based upon existing conditions and the estimated project traffic. These forecast traffic conditions have been prepared to assess the potential impacts of a Project upon the circulation system as it currently exists. This traffic volume scenario and the related intersection capacity analyses will identify the roadway improvements necessary to mitigate the direct traffic impacts of the Project, if any.

**Figures 5-4** and **5-5** present projected AM and PM peak hour traffic volumes at the twenty-five (25) key study intersections and two (2) Project driveways with the addition of the trips generated by the proposed Project to existing traffic volumes, respectively. *Figure 5-5* also presents the Existing Plus Project daily traffic volumes.

TABLE 5-1  
PROJECT TRAFFIC GENERATION RATES AND FORECAST<sup>3</sup>

Description	Daily 2-Way	AM Peak Hour			PM Peak Hour		
		Enter	Exit	Total	Enter	Exit	Total
<b><u>Trip Rates:</u></b>							
▪ 221: Multifamily Housing Mid-Rise (TE/DU)	5.44	26%	74%	0.36	61%	39%	0.44
▪ 820: Shopping Center (TE/1000 SF)	37.75	62%	38%	0.94	48%	52%	3.81
▪ 932: High Turnover Sit-Down Restaurant (TE/1000 SF)	112.18	55%	45%	9.94	62%	38%	9.77
<b><u>Trip Generation:</u></b>							
▪ 4 <sup>th</sup> & Cabrillo Apartments (644 DU)	3,503	60	172	232	173	110	283
▪ 4 <sup>th</sup> & Cabrillo Retail (11,700 SF)	442	7	4	11	22	23	45
▪ 4 <sup>th</sup> & Cabrillo Restaurant (3,500 SF)	393	19	16	35	21	13	34
<b>Total Project Trip Generation:</b>	<b>4,338</b>	<b>86</b>	<b>192</b>	<b>278</b>	<b>216</b>	<b>146</b>	<b>362</b>
<b>Internal Trip Capture (5%)</b>	<b>-217</b>	<b>-4</b>	<b>-10</b>	<b>-14</b>	<b>-11</b>	<b>-7</b>	<b>-18</b>
<b>Total Net Project Trip Generation</b>	<b>4,121</b>	<b>82</b>	<b>182</b>	<b>264</b>	<b>205</b>	<b>139</b>	<b>344</b>

**Notes:**

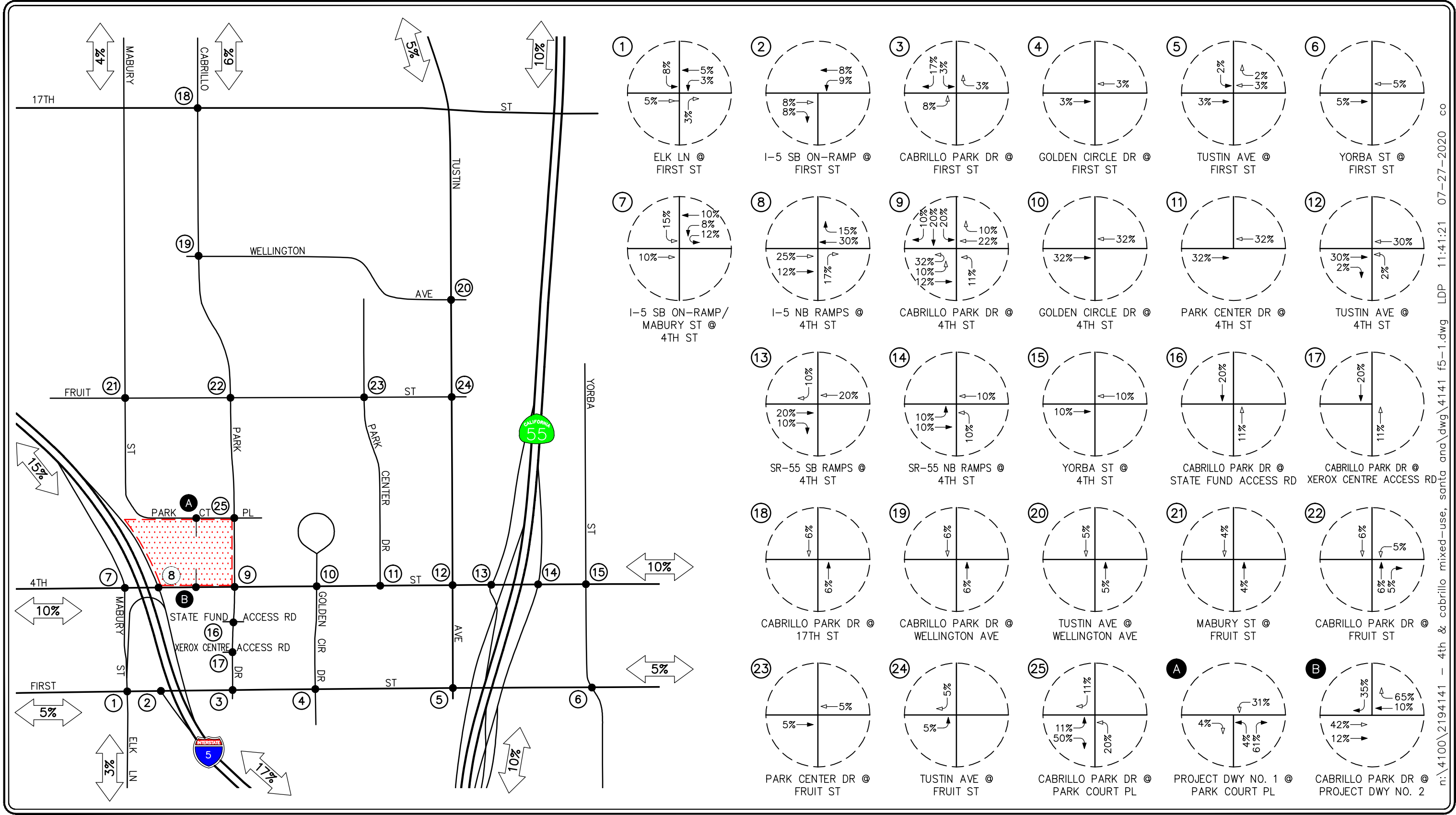
TE/1000 SF = Trip End per 1,000 Square Feet of Gross Floor Area

TE/DU = Trip End per Dwelling Unit

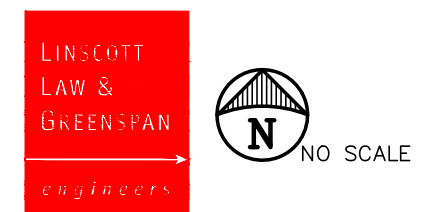
<sup>3</sup> Source: *Trip Generation*, 10<sup>th</sup> Edition, Institute of Transportation Engineers (ITE), Washington, D.C. (2017).

TABLE 5-2  
PROJECT DIRECTIONAL DISTRIBUTION PATTERN

<b>Distribution Percentage</b>	<b>Orientation/Direction</b>
15%	To/from the north via I-5 Freeway
17%	To/from the south via I-5 Freeway
10%	To/from the north via SR-55 Freeway
10%	To/from the south via SR-55 Freeway
6%	To/from the north via Cabrillo Park Drive
4%	To/from the north via Parkcourt Place/Marbury Street
5%	To/from the north via Tustin Avenue
3%	To/from the south via Elk Avenue
10%	To/from the east via Fourth Street/Irvine Boulevard
10%	To/from the west via Fourth Street
5%	To/from the east via First Street
5%	To/from the west via First Street
<b>100%</b>	<b>Total</b>



n:\4100\2194141 - 4th & cabrillo mixed-use, santa ana\dwg\4141 f5-1.dwg LDP 11:41:21 07-27-2020 co

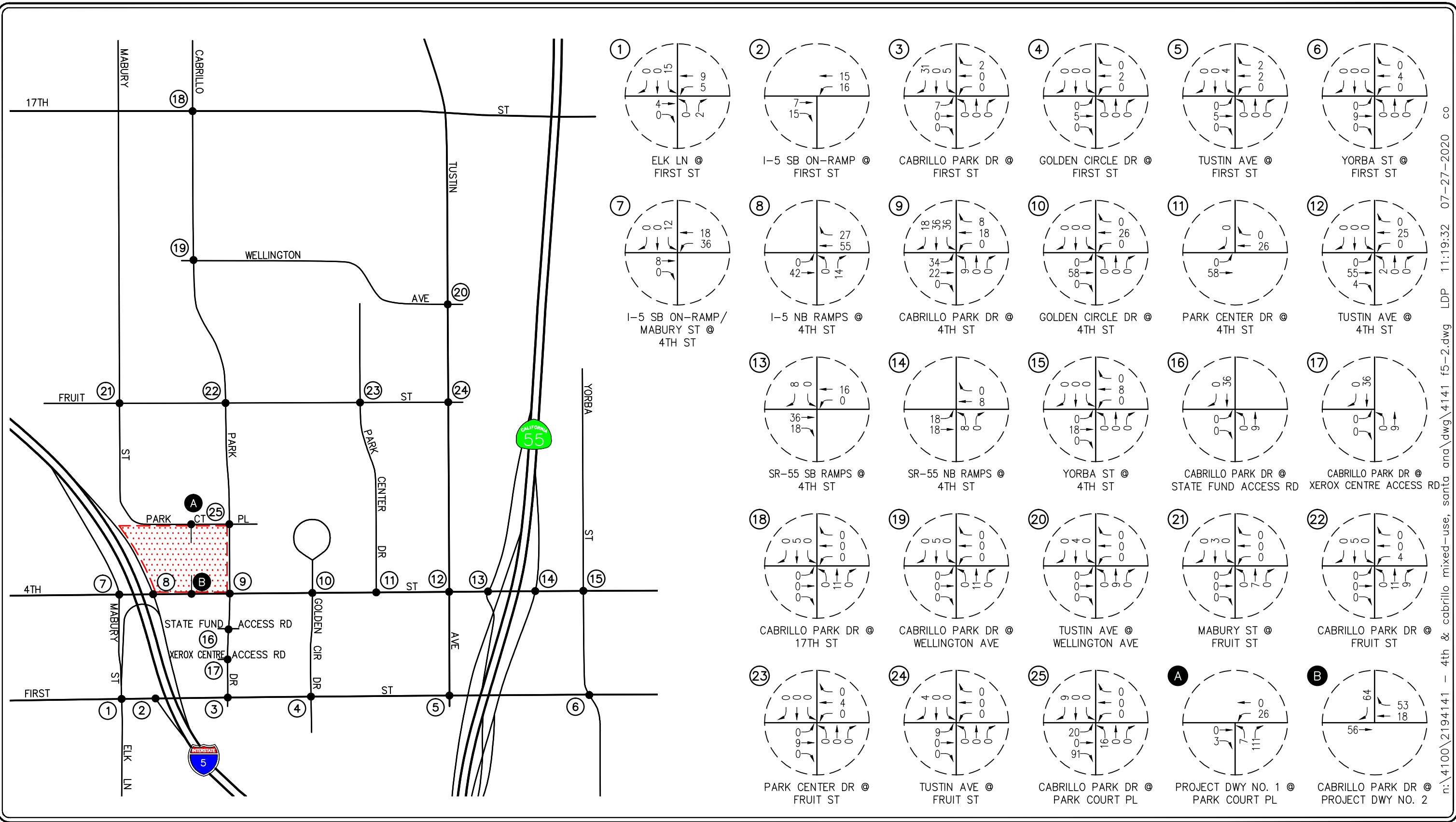


**KEY**

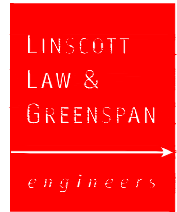
- ① = STUDY INTERSECTION
- ← = INBOUND PERCENTAGE
- = OUTBOUND PERCENTAGE
- ▨ = PROJECT SITE

**FIGURE 5-1**

**PROJECT TRIP DISTRIBUTION PATTERN**  
4TH AND CABRILLO MIXED-USE PROJECT, SANTA ANA



n:\4100\2194141 - 4th & cabrillo mixed-use, santa ana\dwg\4141 f5-2.dwg LDP 11:19:32 07-27-2020 co

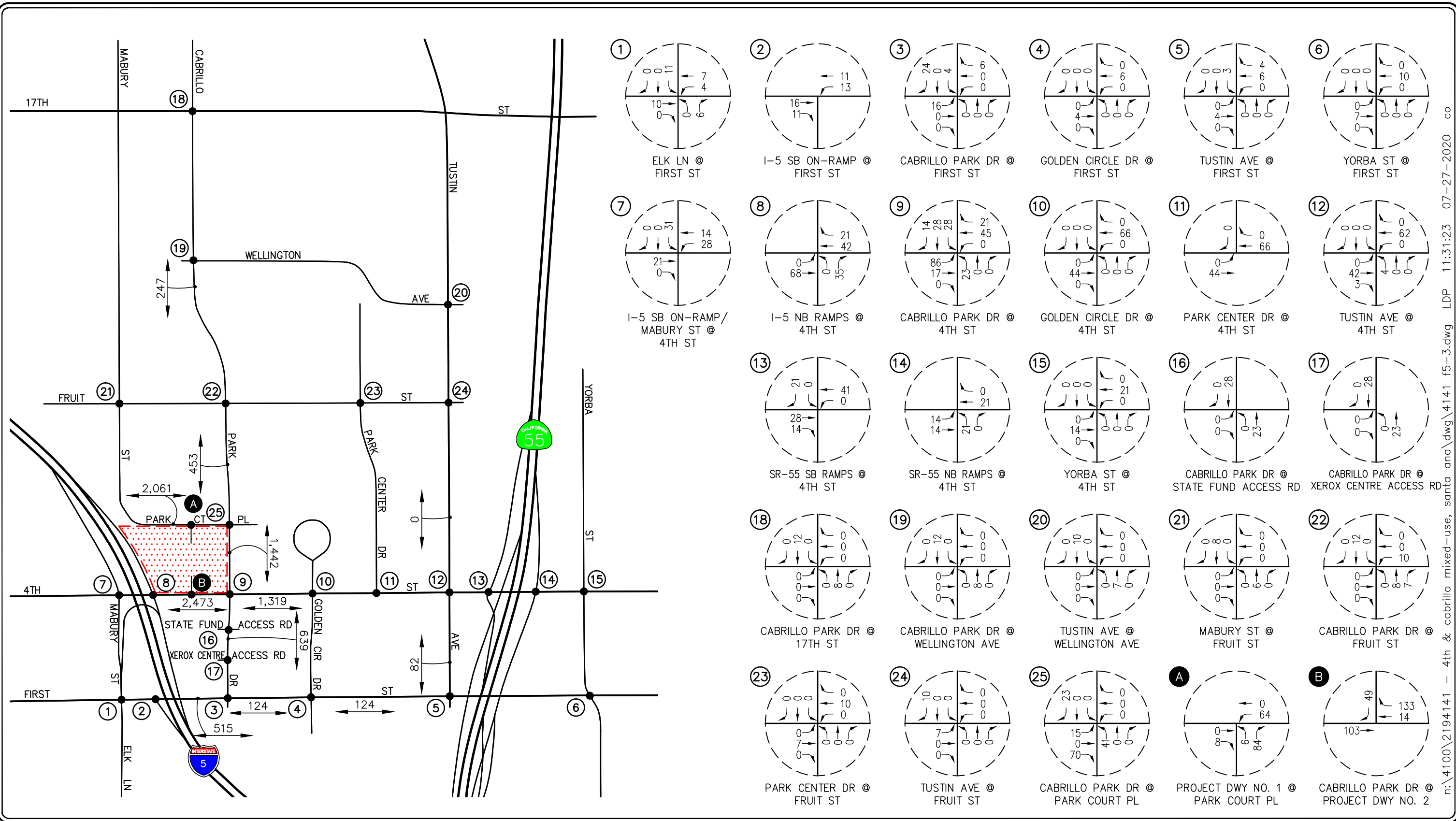


**KEY**  
 # = STUDY INTERSECTION  
 [Red Hatched Box] = PROJECT SITE

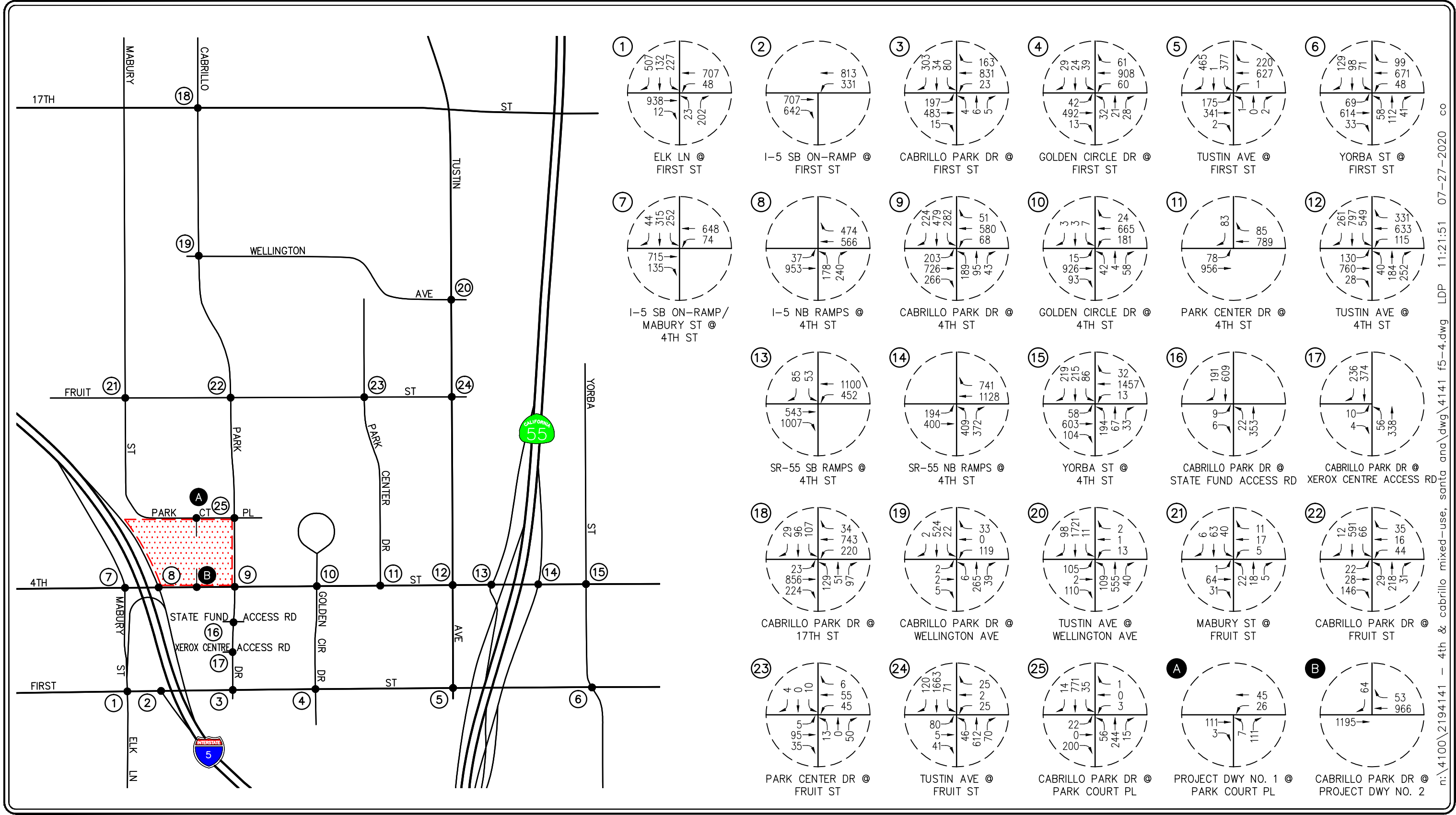
**FIGURE 5-2**

**AM PEAK HOUR PROJECT TRAFFIC VOLUMES**  
 4TH AND CABRILLO MIXED-USE PROJECT, SANTA ANA

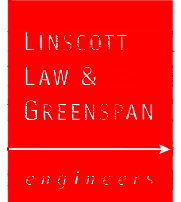




n:\4100\2194141 - 4th & cabrillo mixed-use, santa ana\dwg\4141 f5-3.dwg LDP 11:31:23 07-27-2020 co



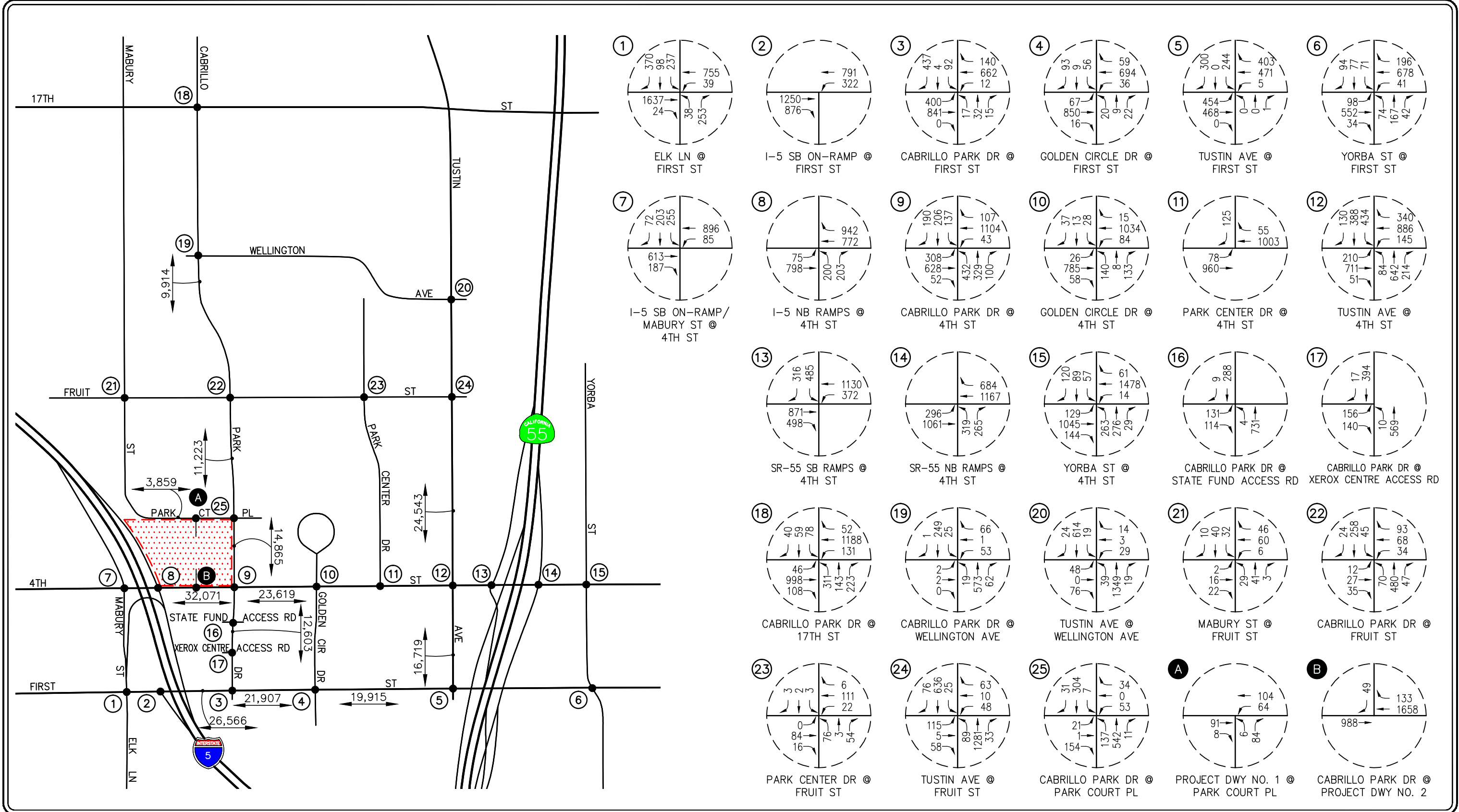
n:\4100\2194141 - 4th & cabrillo mixed-use, santa ana\dwg\4141 f5-4.dwg LDP 11:21:51 07-27-2020 co



**KEY**  
 # = STUDY INTERSECTION  
 [Red Hatched Box] = PROJECT SITE

**FIGURE 5-4**

**EXISTING PLUS PROJECT AM PEAK HOUR TRAFFIC VOLUMES**  
 4TH AND CABRILLO MIXED-USE PROJECT, SANTA ANA



## 6.0 FUTURE TRAFFIC CONDITIONS

### 6.1 Ambient Traffic Growth

Horizon year, background traffic growth estimates have been calculated using an ambient traffic growth factor. The ambient traffic growth factor is intended to include unknown and future related projects in the study area, as well as account for regular growth in traffic volumes due to the development of projects outside the study area. The future growth in traffic volumes has been calculated at one percent (1.0%) per year. Applied to the Year 2019 existing traffic volumes, this factor results in a 6.0% growth in existing volumes to the near-term horizon year 2025.

### 6.2 Related Projects Traffic Characteristics

In order to make a realistic estimate of future on-street conditions prior to implementation of the proposed Project, the status of other known development projects (related projects) within a two-mile radius of the proposed project has been researched at the Cities of Santa Ana and Tustin. With this information, the potential impact of the proposed Project can be evaluated within the context of the cumulative impact of all ongoing development.

Based on our research during the scoping process, there are twenty-eight (28) related projects in the City of Santa Ana and two (2) related projects in the City of Tustin that are being processed for approval. These thirty (30) related projects have been included as part of the cumulative background setting.

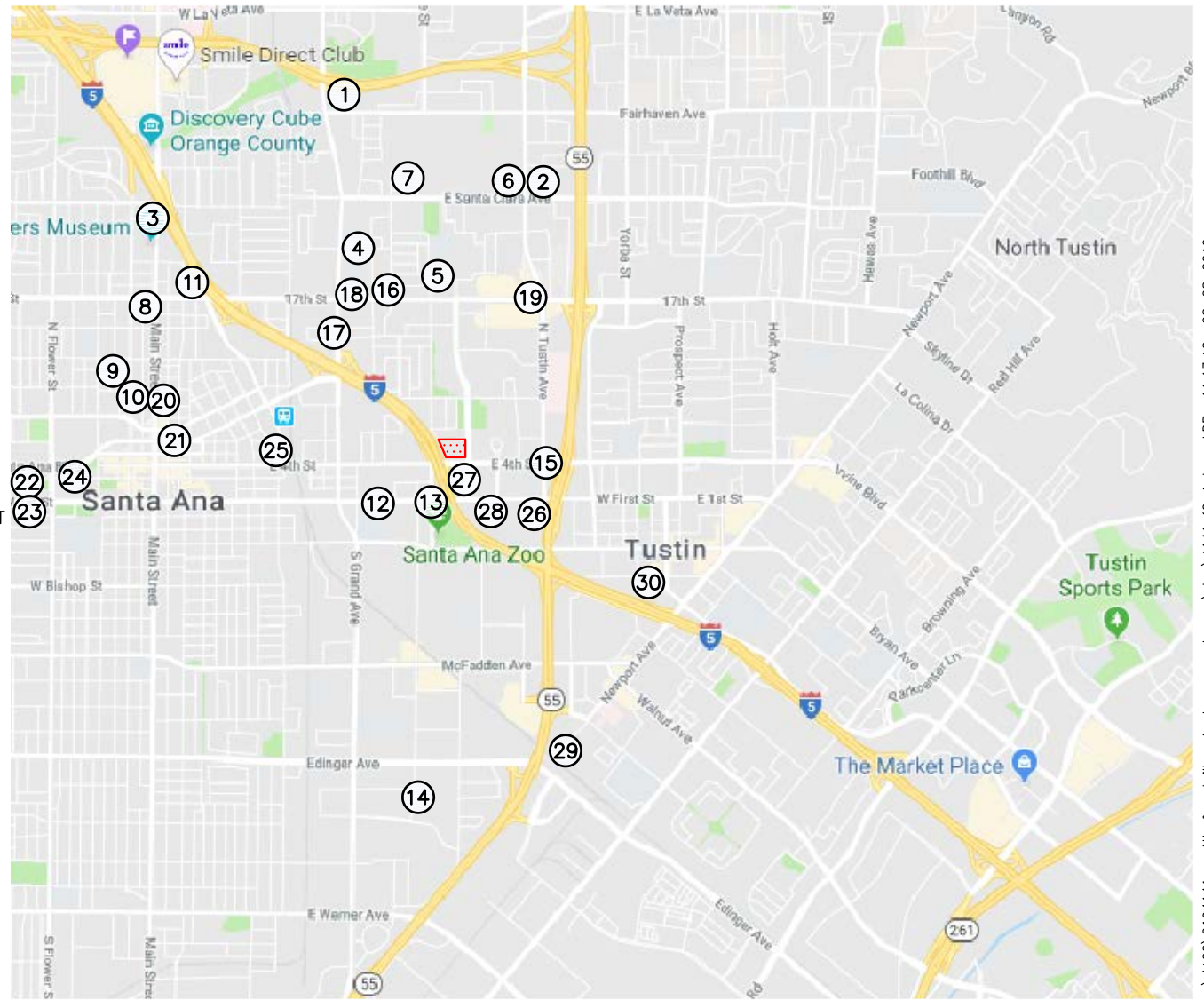
**Table 6-1** provides a brief description for each of the thirty (30) related projects. **Figure 6-1** graphically illustrates the location of the thirty (30) related projects. These related projects are expected to generate vehicular traffic, which may affect the operating conditions of the key study intersections.

**Table 6-2** summarizes the trip generation potential for all thirty (30) related projects on a daily and peak hour basis for a typical weekday. As shown, the related projects are expected to generate 45,942 daily trips, with 3,033 trips (1,458 inbound, 1,575 outbound) anticipated during the AM peak hour and 3,837 trips (1,927 inbound, 1,910 outbound) produced during the PM peak hour.

The AM and PM peak hour traffic volumes associated with the thirty (30) related projects in the Year 2025 are presented in **Figures 6-2** and **6-3**, respectively. **Figure 6-3** also presents the daily related project traffic volumes.

**KEY**

1. STARBUCKS
2. STARBUCKS WITH DRIVE THRU
3. HAMPTON INN HOTEL
4. NORTH GRAND CAR WASH
5. ROCKET EXPRESS CAR WASH
6. TUSTIN SERVICE STATION AND CAR WASH
7. SEXLINGER HOMES AND ORCHARD
8. ARTS COLLECTIVE META HOUSING ADAPTIVE REUSE
9. THE ORLEANS ADAPTIVE REUSE APARTMENTS
10. ONE BROADWAY PLAZA
11. BRIDGING THE AQUA
12. FIRST STREET FAMILY APARTMENTS
13. 1660 FIRST STREET ELKS APARTMENTS
14. ELK'S LODGE
15. RUSSELL FISHER COMMERCIAL
16. EDNOVATE CHARTER HIGH SCHOOL ADAPTIVE REUSE
17. KIDDIE ACADEMY OF SANTA ANA
18. TARGET SHOPPING CENTER
19. RAISING CANE'S RESTAURANT
20. 888 ADAPTIVE REUSE
21. LEGACY SQUARE MIXED-USE DEVELOPMENT
22. FIRST AMERICAN PLAZA
23. 4TH AND MORTIMER (BLOCK A & B)
24. 201 E 4TH STREET
25. TOM'S TRUCK RESIDENTIAL DEVELOPMENT
26. EAST FIRST STREET APARTMENTS
27. THE MADISON
28. 2114 EAST FIRST APARTMENTS
29. SERVICE STATION
30. VINTAGE



n:\4100\2194141 - 4th & cabrillo mixed-use, santa ana.dwg\4141 f6-1.dwg LDP 11:13:10 08-08-2019 co

SOURCE: GOOGLE

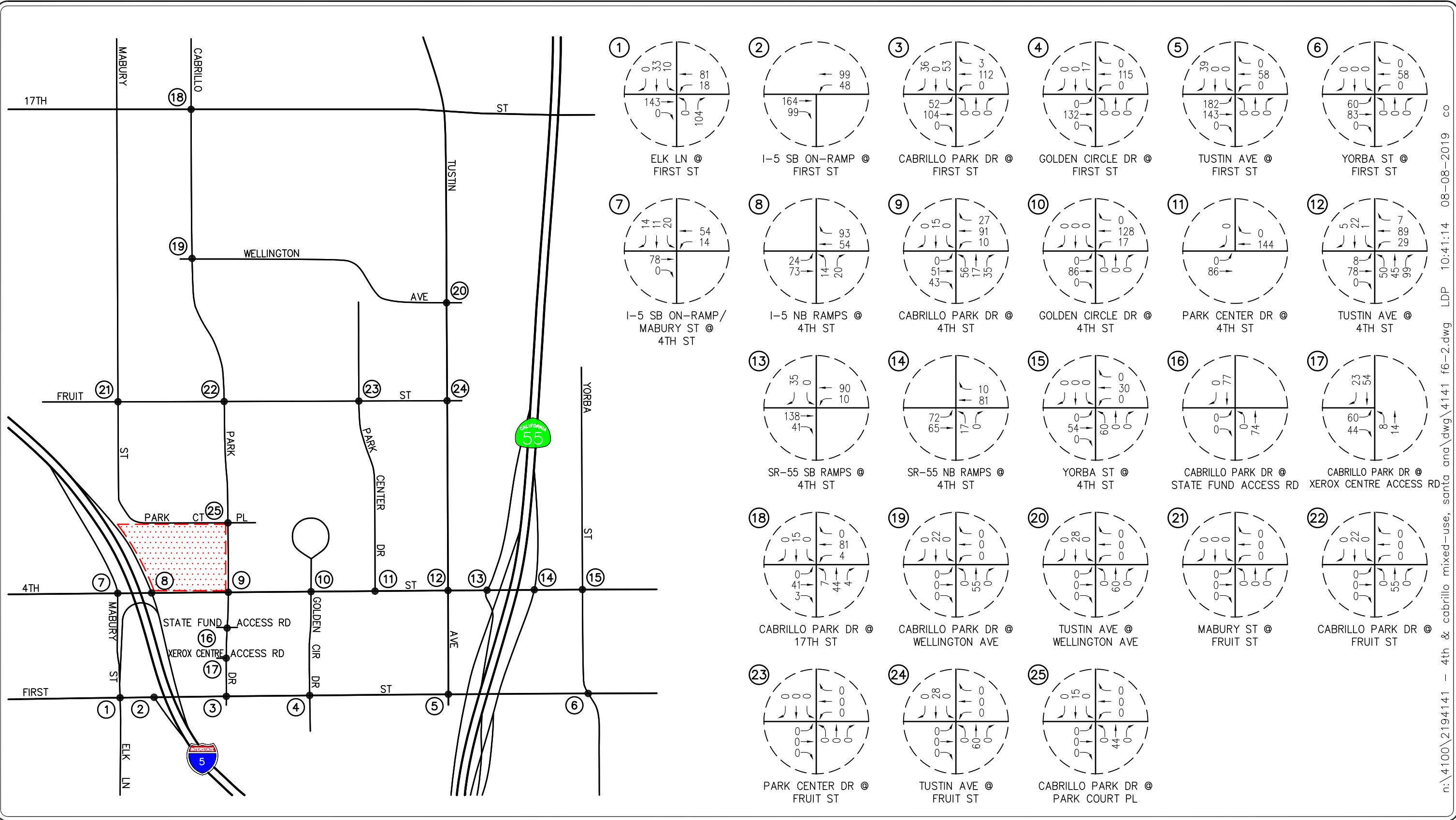
**KEY**

- # = CUMULATIVE PROJECTS LOCATION
- [Red Hatched Square] = PROJECT SITE

**FIGURE 6-1**

**LOCATION OF CUMULATIVE PROJECTS**  
4TH AND CABRILLO MIXED-USE PROJECT, SANTA ANA





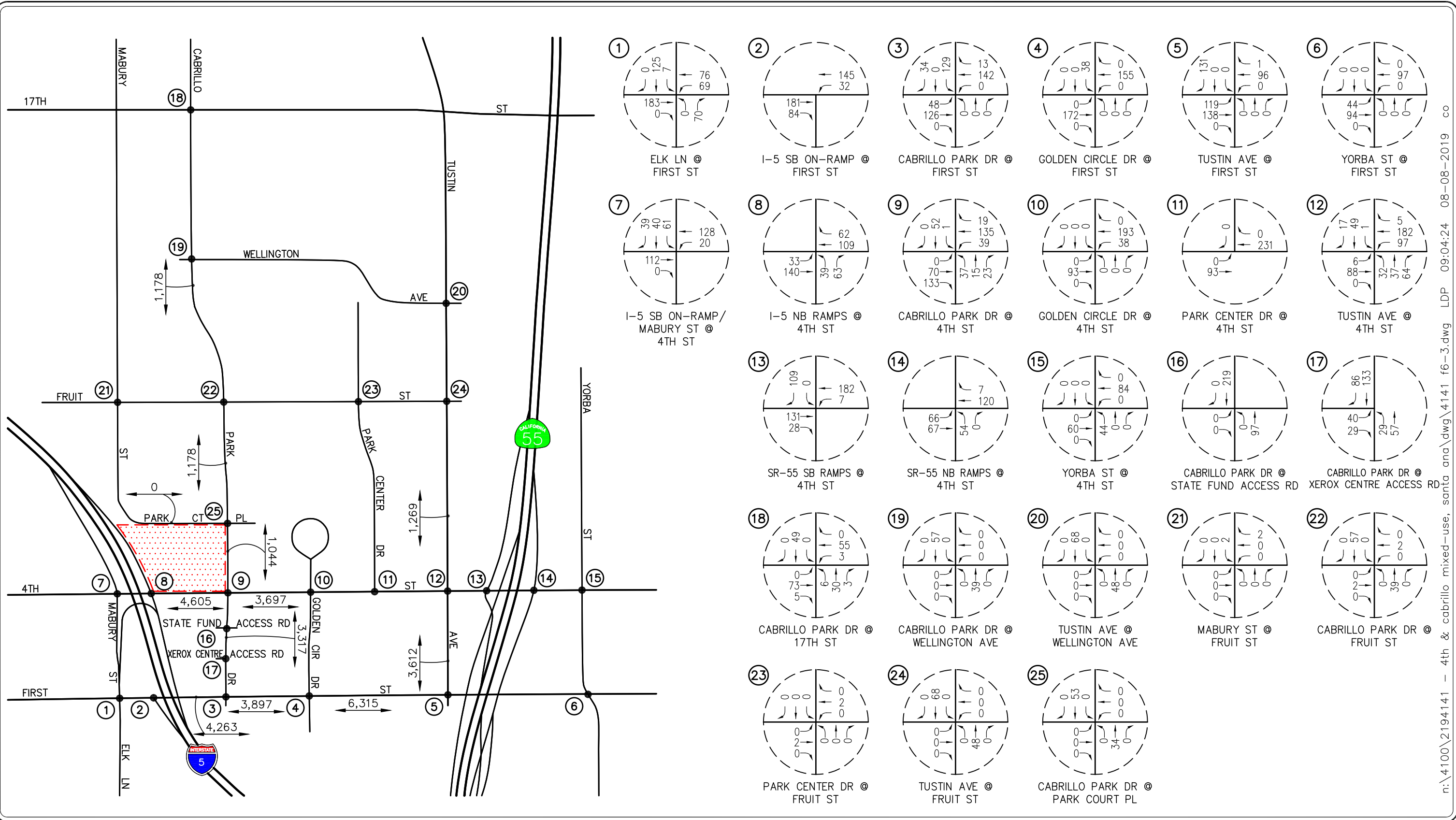
n:\4100\2194141 - 4th & cabrillo mixed-use, santa ana\dwg\4141 f6-2.dwg LDP 10:41:14 08-08-2019 co



**KEY**  
 # = STUDY INTERSECTION  
 [Red Hatched Box] = PROJECT SITE

**FIGURE 6-2**

**AM PEAK HOUR CUMULATIVE PROJECTS TRAFFIC VOLUMES**  
 4TH AND CABRILLO MIXED-USE PROJECT, SANTA ANA



n:\4100\2194141 - 4th & cabrillo mixed-use, santa ana\dwg\4141 f6-3.dwg LDP 09:04:24 08-08-2019 co



**KEY**

- # = STUDY INTERSECTION
- XX,XXX = STUDY ROADWAY SEGMENT
- [Red Hatched Box] = PROJECT SITE

**FIGURE 6-3**  
**PM PEAK HOUR AND DAILY CUMULATIVE PROJECTS TRAFFIC VOLUMES**  
 4TH AND CABRILLO MIXED-USE PROJECT, SANTA ANA

TABLE 6-1  
LOCATION AND DESCRIPTION OF CUMULATIVE PROJECTS<sup>4</sup>

No.	Cumulative Project	Location/Address	Description
<i>City of Santa Ana</i>			
1.	Starbucks	2701 North Grand Avenue	907 SF coffee shop with drive-thru
2.	Starbucks with Drive-thru	2301 North Tustin Avenue	3,567 SF coffee shop with drive-thru
3.	Hampton Inn Hotel	2056, 2058, 2115, 2129 and 2129 North Main Street	2,657 SF commercial, 135 room hotel, and 1,619 SF existing office demolition
4.	North Grand Car Wash	1821 North Grand Ave	5,243 SF carwash and 6,592 SF existing restaurant demolition
5.	Rocket Express Car Wash	1703 East 17 <sup>th</sup> Street	4,292 SF carwash
6.	Tustin Service Station and Car Wash	2230 North Tustin Avenue	3,600 SF commercial
7.	Sexlinger Homes and Orchard	1584 East Santa Clara Avenue	23 DU single-family detached
8.	Arts Collective Meta Housing Adaptive Reuse	1666 North Main Street	58 DU residential apartments
9.	The Orleans Adaptive Reuse Apartments	1212 North Broadway Avenue	24 DU residential apartments
10.	One Broadway Plaza	1109 North Broadway	518,000 SF office tower with 16,000 SF restaurant
11.	Bridging the Aqua	317 East 17 <sup>th</sup> Street	57 DU residential apartments
12.	First Street Family Apartments	1440 East 1 <sup>st</sup> Street	69 DU residential apartments, 47,040 SF existing office demolition
13.	1660 First Street Elks Apartments	1660 East 1 <sup>st</sup> Street	603 DU residential apartments and 20,671 SF retail
14.	Elk's Lodge	1751 South Lyon Street	52,453 SF commercial/lodge
15.	Russell Fisher Commercial	301-325 North Tustin Avenue	10,195 SF commercial, 1,780 SF existing carwash demolition and 3,440 SF existing restaurant demolition
16.	Ednovate Charter High School Adaptive Reuse	1450 East 17 <sup>th</sup> Street	29,368 SF charter high school
17.	Kiddie Academy of Santa Ana	1345 North Grand Avenue	7,657 SF childcare
18.	Target Shopping Center	1330 East 17 <sup>th</sup> Street	9,112 SF commercial

**Notes:**

- SF = Square-feet
- DU = Dwelling units

<sup>4</sup> Source: City of Santa Ana and City of Tustin Planning Department.



TABLE 6-1 (CONTINUED)  
LOCATION AND DESCRIPTION OF CUMULATIVE PROJECTS<sup>5</sup>

No.	Cumulative Project	Location/Address	Description
<i>City of Santa Ana (Continued)</i>			
19.	Raising Cane's Restaurant	2250 East 17 <sup>th</sup> Street	3,935 SF restaurant and 10,000 SF existing restaurant demolition
20.	888 Adaptive Reuse	888 North Main Street	146 Condominiums and 3,700 SF commercial
21.	Legacy Square Mixed-Use Development	609 North Spurgeon Street	93 DU residential apartments and 6,335 SF commercial
22.	First American Plaza	421 North Main Street /114 East 5 <sup>th</sup> Street	220 DU multifamily (mid-rise) and 12,350 SF retail
23.	4 <sup>th</sup> and Mortimer (Block A & B)	409/ 509 East 4 <sup>th</sup> Street	133 DU residential apartments, 105,812 SF commercial and 22,330 SF demolition of commercial building
24.	201 E 4 <sup>th</sup> Street	401 North Bush Street	24 DU residential apartments
25.	Tom's Trucks Residential Development	1008 East 4 <sup>th</sup> Street	133 DU single-family residences
26.	East First Street Apartments	2222 East 1 <sup>st</sup> Street	418 DU senior residential apartments
27.	The Madison	200 North Cabrillo Park Drive	260 DU apartments, 6,561 SF commercial and 2,507 SF retail component of live/work
28.	2114 East First Apartments	2114 East 1 <sup>st</sup> Street	552 DU affordable apartments, 10,000 SF commercial
<i>City of Tustin</i>			
29.	Service Station	1001 Edinger Avenue	6 fueling stations
30.	Vintage	420 West 6 <sup>th</sup> Street	140 DU condominiums

**Notes:**

- SF = Square-feet
- DU = Dwelling units

<sup>5</sup> Source: City of Santa Ana and City of Tustin Planning Department.

TABLE 6-2  
CUMULATIVE PROJECTS TRAFFIC GENERATION FORECAST<sup>6</sup>

Cumulative Project Description	Daily 2-Way	AM Peak Hour			PM Peak Hour		
		In	Out	Total	In	Out	Total
1. Starbucks <sup>7</sup>	372	20	20	40	10	9	19
2. Starbucks with Drive-thru	1,463	81	77	158	39	38	77
3. Hampton Inn Hotel <sup>7</sup>	1,228	38	27	65	46	45	91
4. North Grand Car Wash <sup>7</sup>	740	0	0	0	37	37	74
5. Rocket Express Car Wash	610	0	0	0	31	30	61
6. Tustin Service Station and Car Wash	3,247	64	64	128	114	114	228
7. Sexlinger Homes and Orchard	217	4	13	17	14	9	23
8. Arts Collective Meta Housing Adaptive	425	6	21	27	20	12	32
9. The Orleans Adaptive Reuse Apartments	176	3	8	11	8	5	13
10. One Broadway Plaza <sup>7</sup>	6,660	595	149	744	150	535	685
11. Bridging the Aqua	417	6	20	26	20	12	32
12. First Street Family Apartments <sup>8</sup>	459	7	28	35	28	15	43
13. 1660 First Street Elks Apartments <sup>9</sup>	4,648	70	242	312	266	162	428
14. Elk's Lodge	1,512	61	31	92	57	64	121
15. Russell Fisher Commercial <sup>7</sup>	346	5	4	9	13	13	26
16. Ednovate Charter High School Adaptive <sup>7</sup>	413	70	29	99	15	13	28
17. Kiddie Academy of Santa Ana <sup>7</sup>	365	45	39	84	40	45	85
18. Target Shopping Center	310	5	3	8	11	12	23
19. Raising Cane's Restaurant	926	41	40	81	33	31	64
20. 888 Adaptive Reuse <sup>7</sup>	1,209	17	53	70	59	37	96
21. Legacy Square Mixed-Use Development	2,833	43	54	97	110	101	211
22. First American Plaza <sup>7</sup>	1,420	26	59	85	70	52	122
23. 4th and Mortimer (Block A & B)	4,569	69	81	150	174	166	340
24. 201 E 4th Street	176	3	8	11	8	5	13
25. Tom's Trucks Residential Development <sup>7</sup>	1,256	25	73	98	83	49	132

<sup>6</sup> Unless otherwise noted, Source: *Trip Generation*, 10<sup>th</sup> Edition, Institute of Transportation Engineers (ITE), Washington, D.C. (2017).

<sup>7</sup> Source: *First American Plaza TIA*, prepared by LLG, dated April 2019.

<sup>8</sup> Source: *First Street Family Apartments TIA*, prepared by LLG, dated January 2016.

<sup>9</sup> Source: *1660 E. First Street Elks Apartments TIA*, prepared by LLG, dated June 2019.

TABLE 6-2 (CONTINUED)  
 CUMULATIVE PROJECTS TRAFFIC GENERATION FORECAST<sup>10</sup>

Cumulative Project Description	Daily 2-Way	AM Peak Hour			PM Peak Hour		
		In	Out	Total	In	Out	Total
26. East First Street Apartments	1,785	33	67	100	76	49	125
27. The Madison <sup>11</sup>	2,010	30	104	134	115	69	184
28. 2114 East First Apartments <sup>12</sup>	4,381	63	199	262	207	127	334
29. Service Station	744	13	13	26	24	25	49
30. Vintage	1,025	15	49	64	49	29	78
<b>Cumulative Projects Total Trip Generation Potential</b>	<b>45,942</b>	<b>1,458</b>	<b>1,575</b>	<b>3,033</b>	<b>1,927</b>	<b>1,910</b>	<b>3,837</b>

<sup>10</sup> Unless otherwise noted, Source: *Trip Generation*, 10<sup>th</sup> Edition, Institute of Transportation Engineers (ITE), Washington, D.C. (2017).

<sup>11</sup> Source: *The Madison Mixed-Use Development TIA*, prepared by LLG, dated August 2017.

<sup>12</sup> Source: *First American Plaza TIA*, prepared by LLG, dated April 2019.

### 6.3 Year 2040 Traffic Conditions

As coordinated with City staff, the Year 2040 traffic volume forecasts for this traffic study were developed via the utilization of the OCTAM 4.0 Year 2040 traffic model provided by OCTA. Specifically, daily, AM peak period and PM peak period link traffic volumes were provided by OCTA for the existing base year (i.e. Year 2012) and for the Year 2040 year. The AM peak period corresponds to a three-hour morning commute period while the PM peak period corresponds to a four-hour afternoon commute period. Using the peak period model runs and the OCTA approved peak hour factors (i.e. AM = 0.3566 and PM = 0.2662), the one-hour peak hour link traffic volumes were determined. These future year 2040 link traffic volumes were post-processed based on the relationship of the base year validation model run output to the base year ground traffic counts resulting in Year 2040 without project daily traffic volumes for the AM peak hour/PM peak hour turning movements for the key study intersections. Copies of the model post-processing worksheets are contained in *Appendix C*.

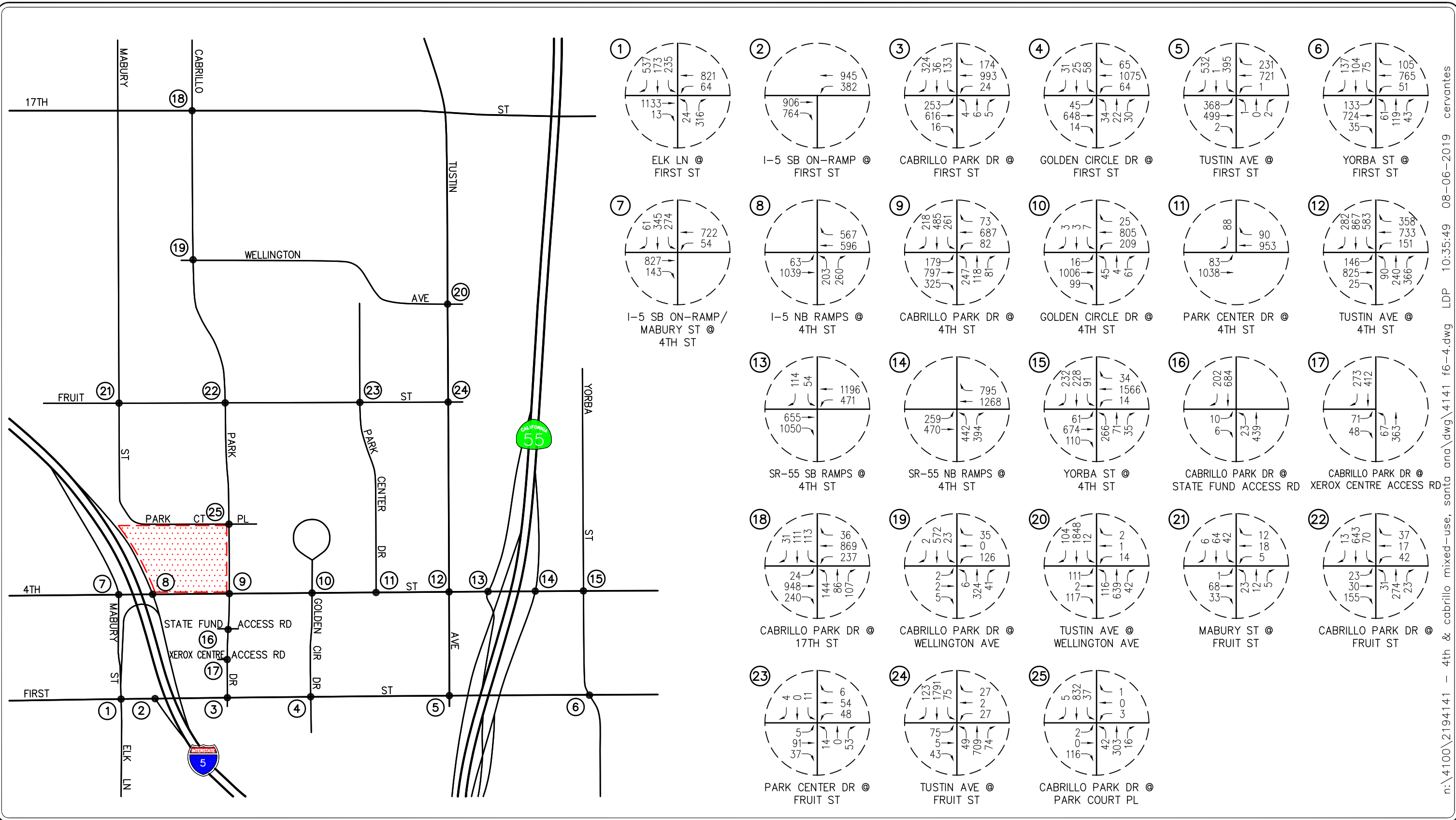
### 6.4 Year 2025 and Year 2040 Traffic Volumes

#### 6.4.1 Year 2025 Traffic Volumes

**Figures 6-4** and **6-5** present the AM and PM peak hour cumulative traffic volumes (existing traffic + ambient growth + related projects) at twenty-five (25) key study intersections for the Year 2025, respectively. *Figure 6-5* also presents the Year 2025 daily cumulative traffic volumes. **Figures 6-6** and **6-7** illustrate the Year 2025 forecast AM and PM peak hour traffic volumes, with the inclusion of the trips generated by the proposed Project, respectively. *Figure 6-7* also presents the Year 2025 cumulative plus project daily traffic volumes.

#### 6.4.2 Year 2040 Traffic Volumes

**Figures 6-8** and **6-9** present the Year 2040 AM and PM peak hour cumulative traffic volumes at the twenty-five (25) key study intersections, respectively. *Figure 6-9* also presents the Year 2040 daily cumulative traffic volumes. **Figures 6-10** and **6-11** illustrate the Year 2040 forecast AM and PM peak hour traffic volumes, with the inclusion of the trips generated by the proposed Project, respectively. *Figure 6-11* also presents the Year 2040 buildout plus project daily traffic volumes.



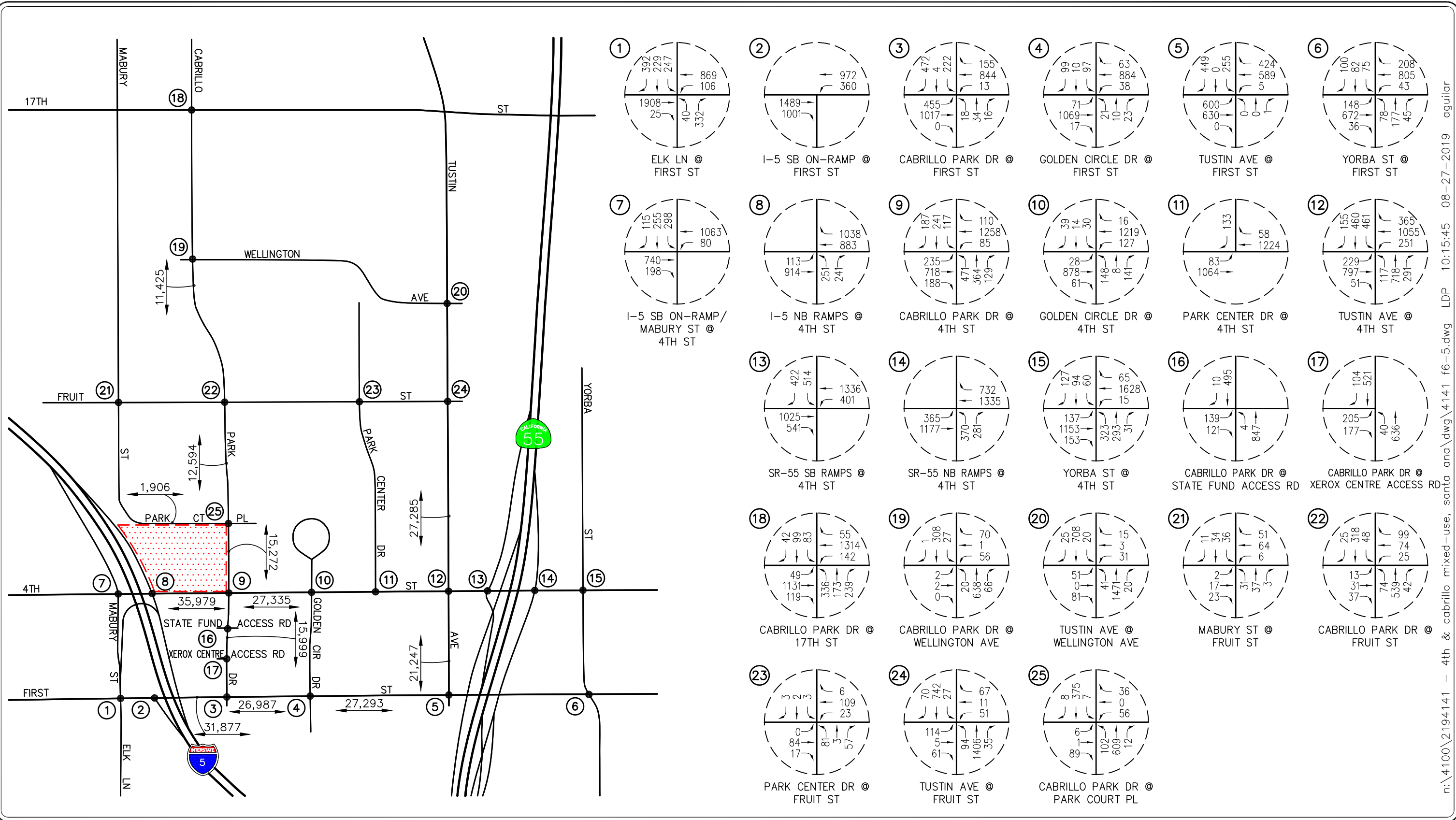
n:\4100\2194141 - 4th & cabrillo mixed-use, santa ana\dwg\4141 f6-4.dwg LDP 10:35:49 08-06-2019 cervantes



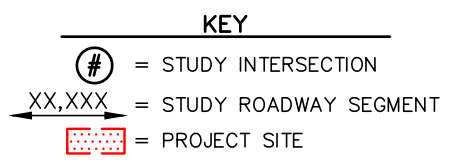
**KEY**  
 # = STUDY INTERSECTION  
 [Red Hatched Box] = PROJECT SITE

**FIGURE 6-4**

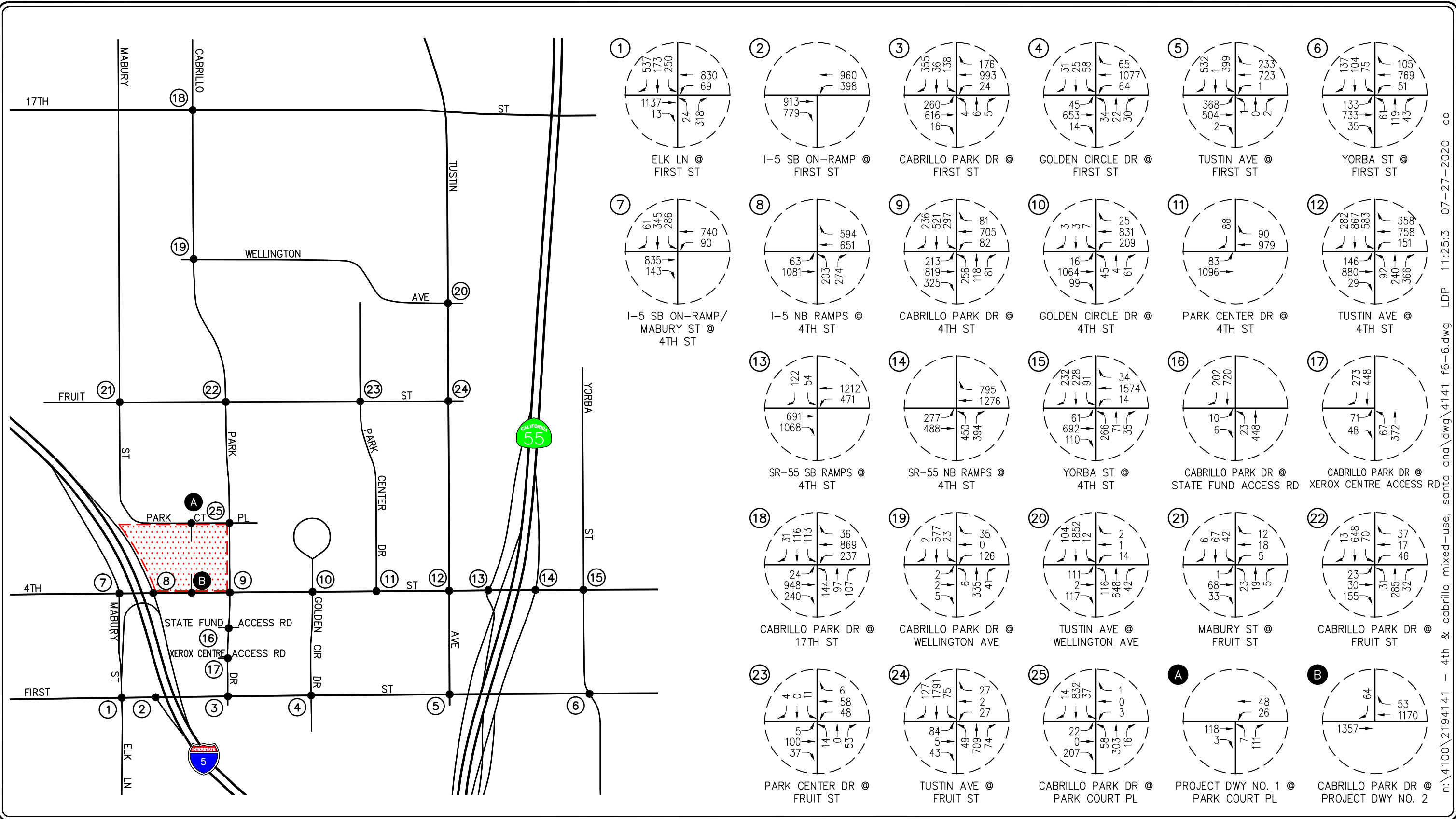
**YEAR 2025 CUMULATIVE AM PEAK HOUR TRAFFIC VOLUMES**  
 4TH AND CABRILLO MIXED-USE PROJECT, SANTA ANA

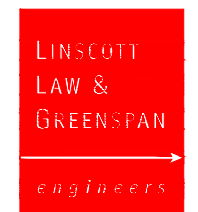
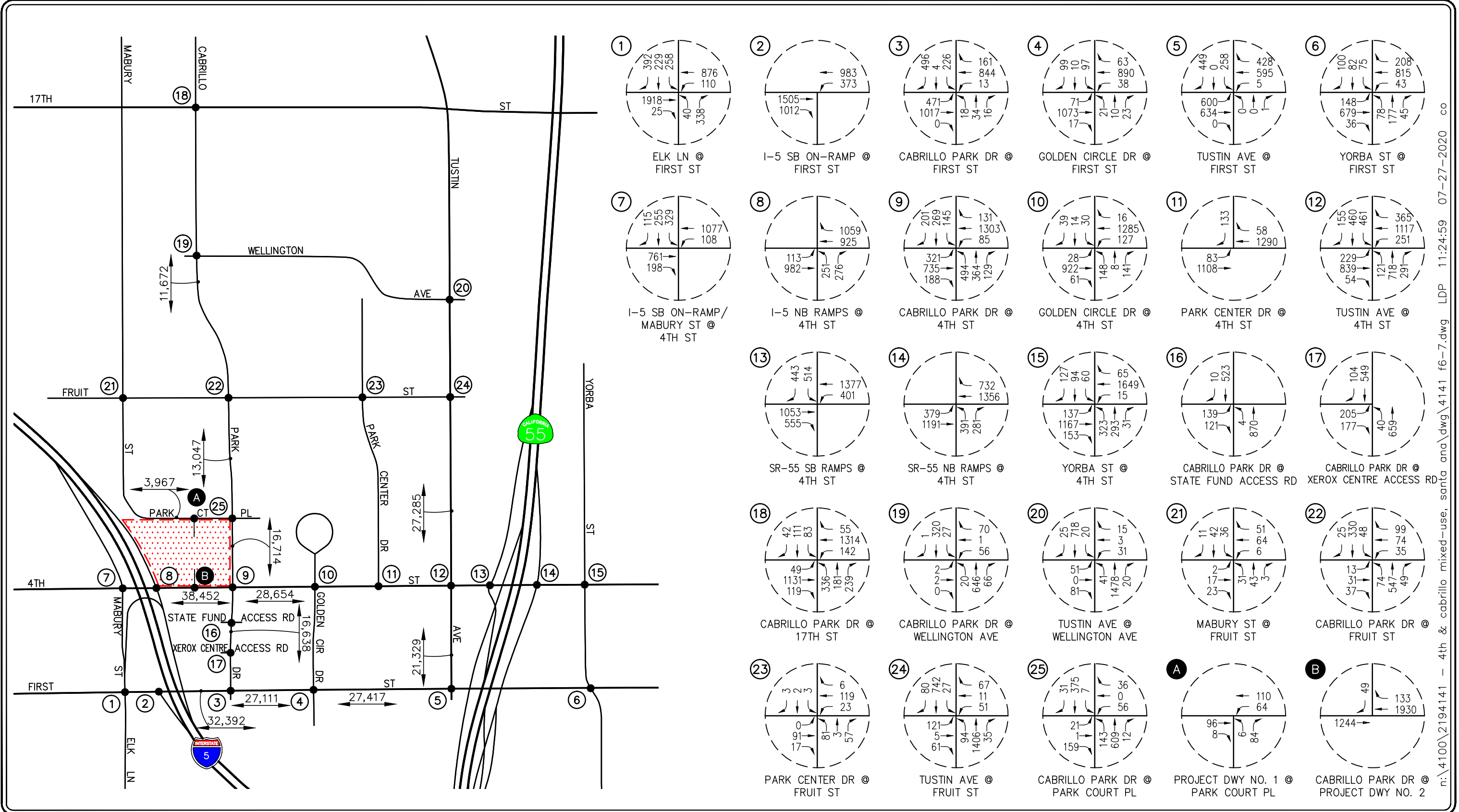


n:\4100\2194141 - 4th & cabrillo mixed-use, santa ana\dwg\4141 f6-5.dwg LDP 10:15:45 08-27-2019 aguilar



**FIGURE 6-5**  
**YEAR 2025 CUMULATIVE PM PEAK HOUR AND DAILY TRAFFIC VOLUMES**  
 4TH AND CABRILLO MIXED-USE PROJECT, SANTA ANA





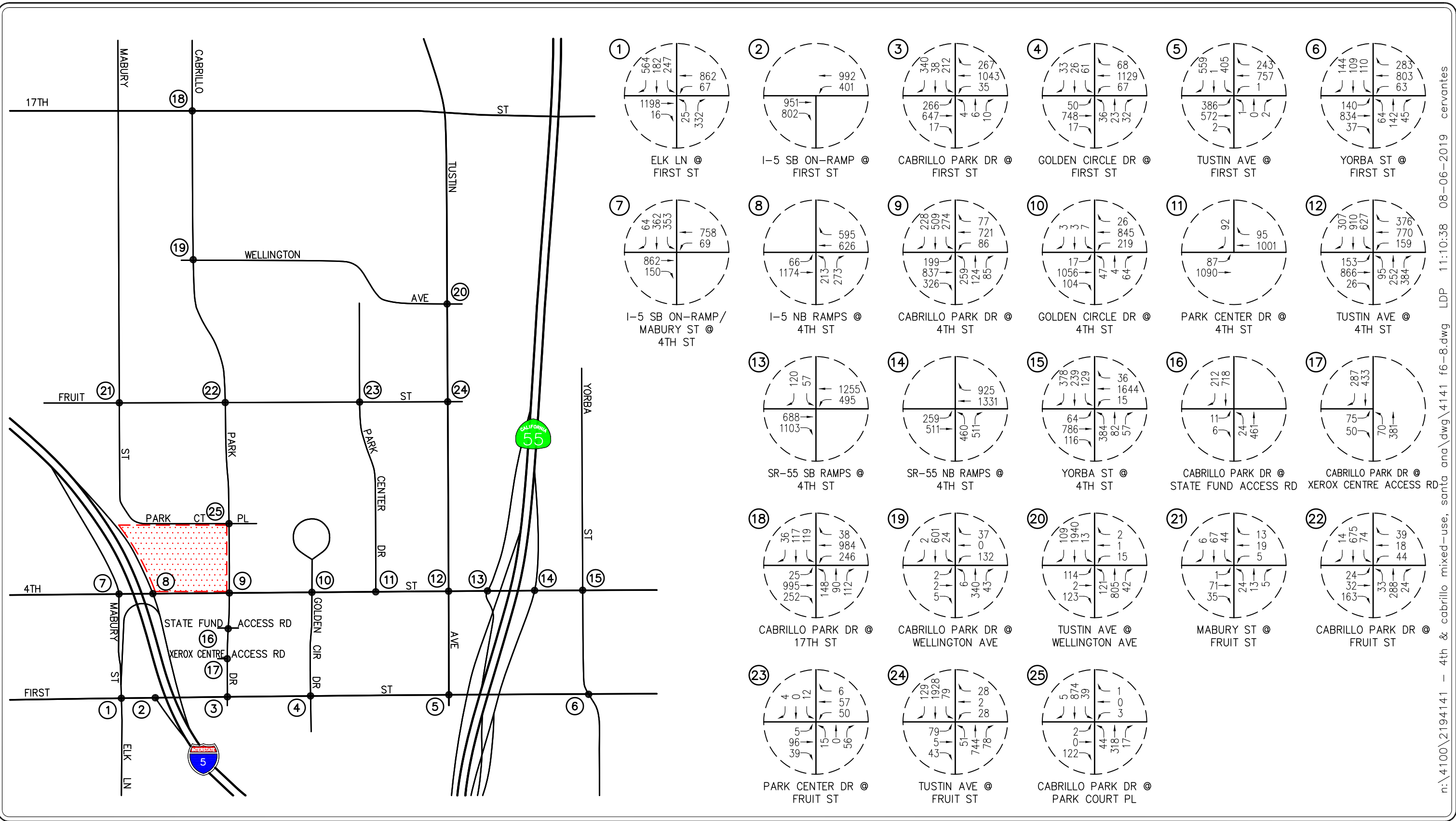
**KEY**

- # = STUDY INTERSECTION
- XX,XXX = STUDY ROADWAY SEGMENT
- [Red Hatched Box] = PROJECT SITE

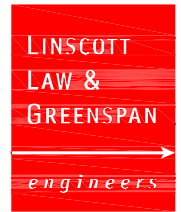
**FIGURE 6-7**  
**YEAR 2025 CUMULATIVE PLUS PROJECT**  
**PM PEAK HOUR AND DAILY TRAFFIC VOLUMES**  
 4TH AND CABRILLO MIXED-USE PROJECT, SANTA ANA

n:\4100\2194141 - 4th & cabrillo mixed-use, santa ana\dwg\4141 f6-7.dwg LDP 11:24:59 07-27-2020 co





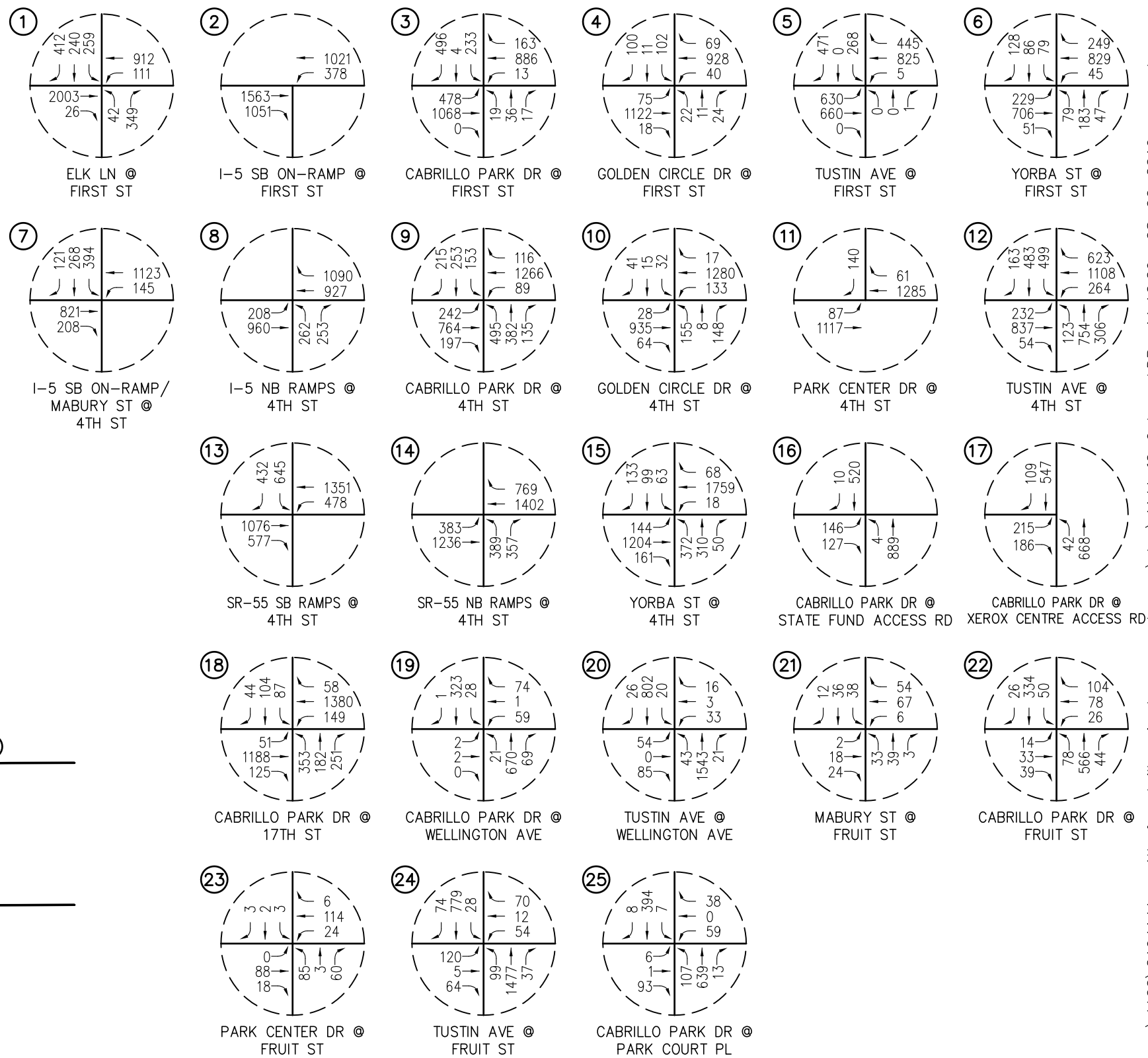
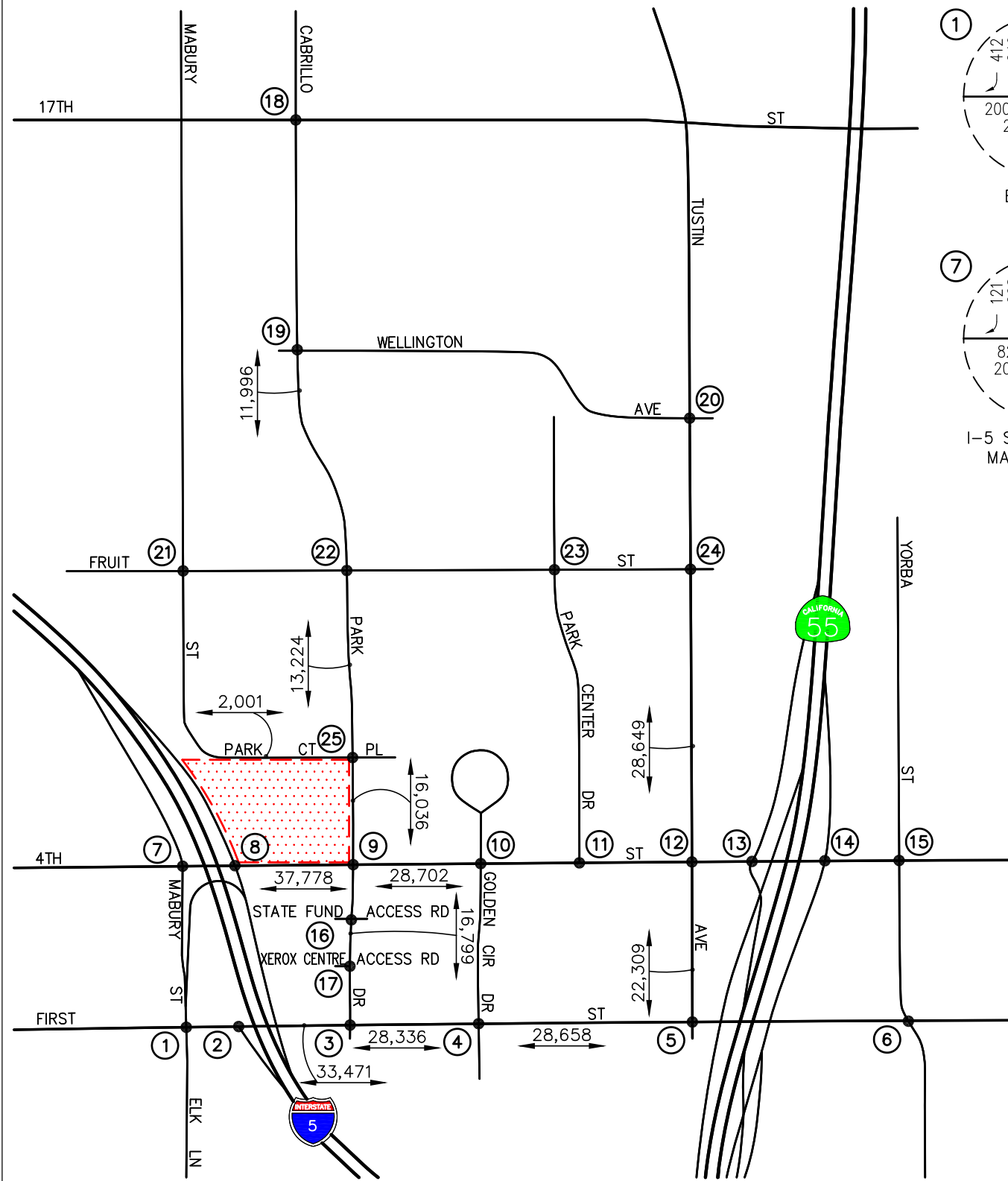
n:\4100\2194141 - 4th & cabrillo mixed-use, santa ana\dwg\4141 f6-8.dwg LDP 11:10:38 08-06-2019 cervantes

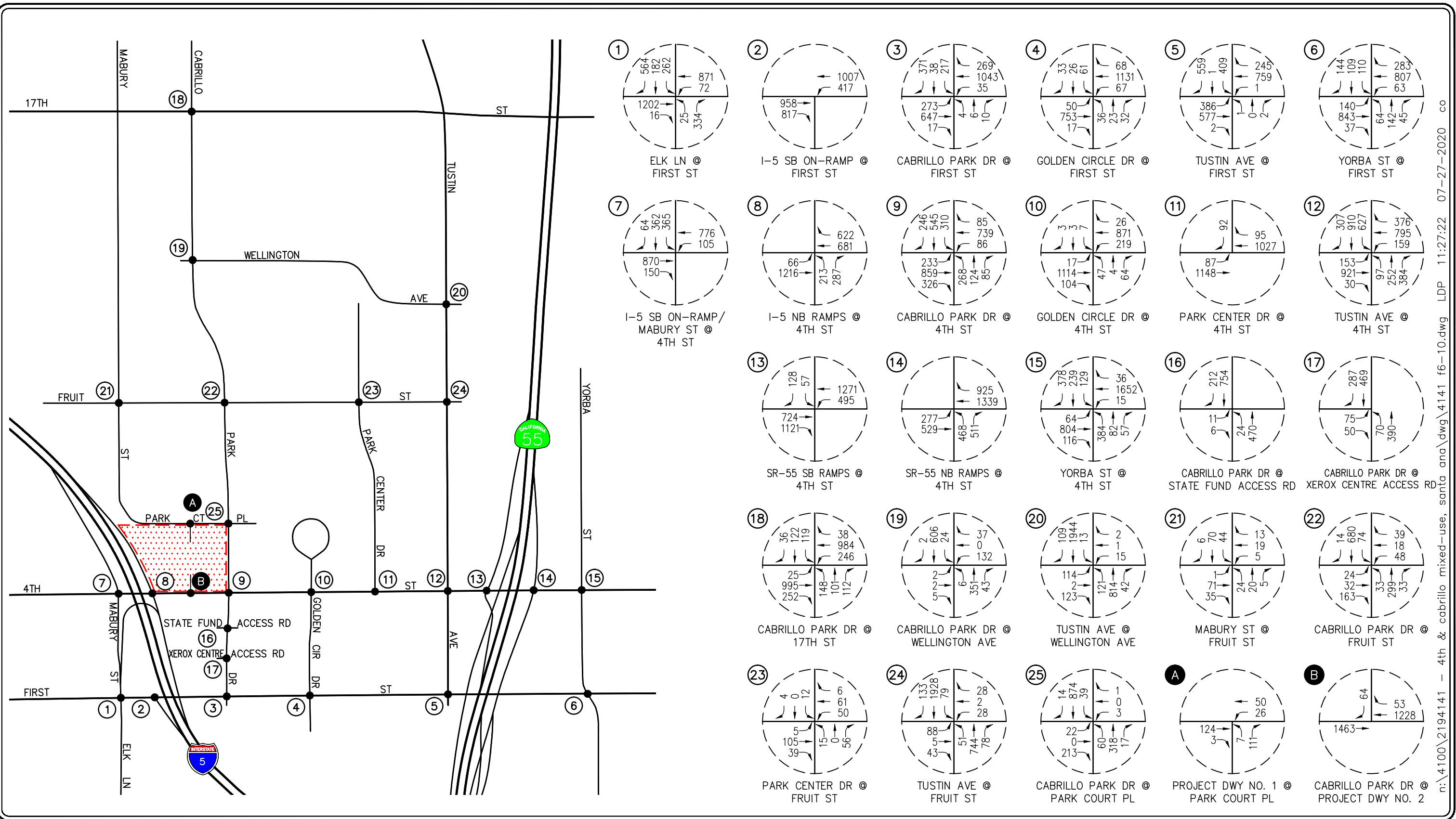


**KEY**  
 # = STUDY INTERSECTION  
 [Red Hatched Box] = PROJECT SITE

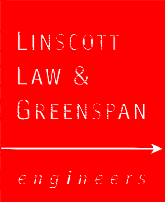
**FIGURE 6-8**

**YEAR 2040 BUILDOUT AM PEAK HOUR TRAFFIC VOLUMES**  
 4TH AND CABRILLO MIXED-USE PROJECT, SANTA ANA



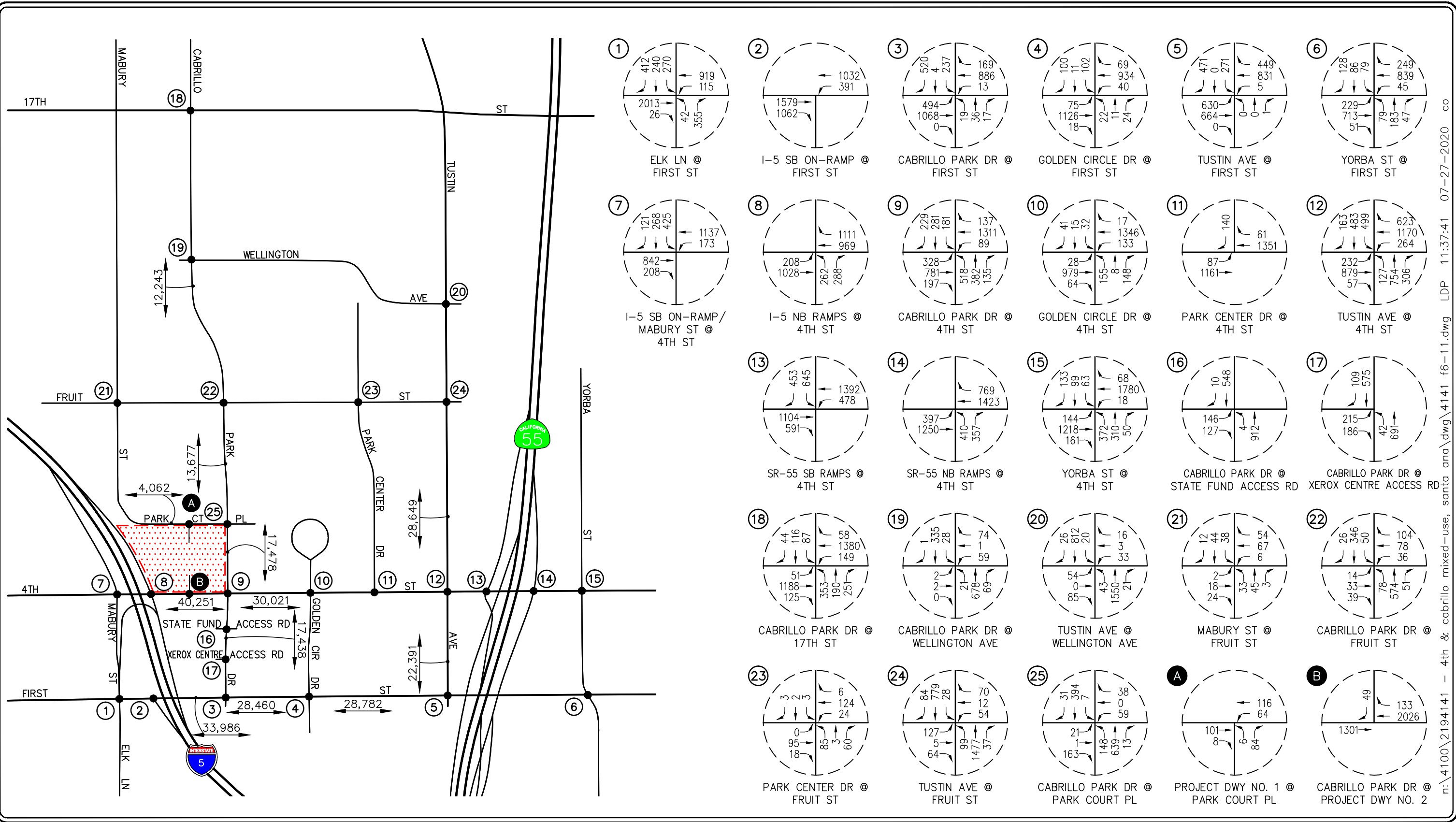


n:\4100\2194141 - 4th & cabrillo mixed-use, santa ana\dwg\4141 f6-10.dwg LDP 11:27:22 07-27-2020 co



**KEY**  
 # = STUDY INTERSECTION  
 [Red Hatched Box] = PROJECT SITE

**FIGURE 6-10**  
**YEAR 2040 BUILDOUT PLUS PROJECT**  
**AM PEAK HOUR TRAFFIC VOLUMES**  
 4TH AND CABRILLO MIXED-USE PROJECT, SANTA ANA



**FIGURE 6-11**  
YEAR 2040 BUILDOUT PLUS PROJECT  
PM PEAK HOUR AND DAILY TRAFFIC VOLUMES  
4TH AND CABRILLO MIXED-USE PROJECT, SANTA ANA

n:\4100\2194141 - 4th & cabrillo mixed-use, santa ana\dwg\4141 f6-11.dwg LDP 11:37:41 07-27-2020 co

## 7.0 TRAFFIC IMPACT ANALYSIS METHODOLOGY

The relative impact of the proposed Project during the AM peak hour and PM peak hour was evaluated based on analysis of future operating conditions at the twenty-five (25) key study intersections, without, then with, the proposed Project. The previously discussed capacity analysis procedures were utilized to investigate the future volume-to-capacity relationships and service level characteristics at each study intersection. The significance of the potential impacts of the Project at each key intersection was then evaluated using the following traffic impact criteria.

### 7.1 Impact Criteria and Thresholds

#### 7.1.1 City of Santa Ana

Based on the City of Santa Ana, impacts to local and regional transportation systems are considered significant if any of the following would occur:

- Project traffic would cause an intersection currently operating at an acceptable peak hour Level of Service (LOS) to operate at an unacceptable peak hour LOS. The City of Santa Ana considers LOS D to be the minimum acceptable LOS for all intersections, except for those locations located within the City's defined major development areas, where LOS E is considered acceptable. Based on the above, the following summarizes the LOS required for each key study intersection:
  - **LOS "D" Requirements:**

1. Elk Lane at First Street	19. Cabrillo Park Drive at Wellington Avenue
2. I-5 SB On-Ramp at First Street	21. Mabury Street at Fruit Street
7. I-5 SB On-Ramp/Mabury Street at 4 <sup>th</sup> Street	22. Cabrillo Park Drive at Fruit Street
8. I-5 NB Ramps at 4 <sup>th</sup> Street	23. Park Center Drive at Fruit Street
13. SR-55 SB Ramps at 4 <sup>th</sup> Street	25. Cabrillo Park Drive at Park Court Place
18. Cabrillo Park Drive at 17 <sup>th</sup> Street	
  - **LOS "E" Requirements:**

3. Cabrillo Park Drive at First Street	12. Tustin Avenue at 4 <sup>th</sup> Street
4. Golden Circle Drive at First Street	16. Cabrillo Park Drive at State Fund Access Road
9. Cabrillo Park Drive at 4 <sup>th</sup> Street	17. Cabrillo Park Drive at Xerox Center Access Road
10. Golden Circle Drive at 4 <sup>th</sup> Street	20. Tustin Avenue at Wellington Avenue
11. Park Center Drive at 4 <sup>th</sup> Street	24. Tustin Avenue at Fruit Street
- The project increases traffic demand by 1% of capacity (ICU increase  $\geq 0.01$ ) at a signalized study intersection forecast to operate at an acceptable LOS.
- At unsignalized intersections, an impact is considered to be significant if the project causes an intersection at LOS D or better to degrade to LOS E or F and the traffic signal warrant analysis determines that a signal is justified.

### 7.1.2 City of Tustin

For those study intersections within the jurisdiction of the City of Tustin, impacts to local and regional transportation systems are considered significant if:

- An unacceptable peak hour Level of Service (LOS) at any of the key intersections is projected. The City of Tustin considers LOS D to be the minimum acceptable condition that should be maintained during the peak commute hours. For this analysis, if the project increases traffic demand at the study intersection by 1% of capacity (ICU increase  $\geq 0.010$ ), causing or worsening LOS E or F (ICU  $> 0.901$ ), the impact is considered significant.

### 7.2 Traffic Impact Analysis Scenarios

The following scenarios are those for which volume/capacity calculations have been performed at the twenty-five (25) key intersections for existing plus project, near-term (Year 2025) and long-term (Year 2040) traffic conditions:

- A. Existing Traffic Conditions;
- B. Existing Plus Project Traffic Conditions;
- C. Scenario (B) with Improvements, if necessary;
- D. Near-Term (Year 2025) Cumulative Traffic Conditions,
- E. Near-Term (Year 2025) Cumulative plus Project Traffic Conditions;
- F. Scenario (E) with Improvements, if necessary;
- G. Long-Term (Year 2040) Future Traffic Conditions;
- H. Long-Term (Year 2040) Future Traffic Conditions plus Project Traffic; and
- I. Scenario (H) with Improvements, if necessary.

## 8.0 PEAK HOUR INTERSECTION CAPACITY ANALYSIS

### 8.1 Existing Plus Project Analysis

**Table 8-1** summarizes the peak hour Level of Service results at the twenty-five (25) key study intersections for existing plus project traffic conditions. The first column (1) of ICU/LOS values and HCM/LOS values in *Table 8-1* presents a summary of existing AM and PM peak hour traffic conditions (which were also presented in *Table 3-3*). The second column (2) lists existing plus project traffic conditions. The third column (3) shows the increase in ICU value and/or HCM value due to the added peak hour Project trips and indicates whether the traffic associated with the Project will have a significant impact based on the LOS standards and significant impact criteria defined in this report. The fourth column (4) presents the resultant level of service with the inclusion of recommended traffic improvements, where needed, to achieve an acceptable level of service.

#### 8.1.1 Existing Plus Project Traffic Conditions

Review of columns (2) and (3) of *Table 8-1* indicates that traffic associated with the proposed Project will significantly impact one (1) of the twenty-five study intersections, when compared to the LOS standards and significant impact criteria specified in this report. The impacted intersection of SR-55 SB Ramps/4<sup>th</sup> Street is forecast to operate at LOS E during the AM peak hour. The remaining study intersections are forecast to operate at acceptable level of service during the AM and PM peak hours.

Review of column (4) of *Table 8-1* indicates that the implementation of recommended improvements at the intersection will help offset the Project's impact. Planned and recommended improvements are discussed in Section 11.0.

*Appendix D* presents the existing plus project ICU/LOS and HCM/LOS calculations for the twenty-five (25) key study intersections.

TABLE 8-1  
EXISTING PLUS PROJECT PEAK HOUR INTERSECTION CAPACITY ANALYSIS

Key Intersection	Minimum Acceptable LOS	Time Period	(1) Existing Traffic Conditions		(2) Existing Plus Project Traffic Conditions		(3) Significant Impact		(4) Existing Plus Project Plus Improvements Traffic Conditions	
			ICU/HCM	LOS	ICU/HCM	LOS	Increase	Yes/No	ICU/HCM	LOS
1. Elk Lane at First Street	D	AM	0.599	A	0.604	B	0.005	No	--	--
		PM	0.716	C	0.725	C	0.009	No	--	--
2. I-5 SB On Ramp at First Street	D	AM	0.425	A	0.434	A	0.009	No	--	--
		PM	0.584	A	0.594	A	0.010	No	--	--
3. Cabrillo Park Drive at First Street	E	AM	0.450	A	0.458	A	0.008	No	--	--
		PM	0.544	A	0.558	A	0.014	No	--	--
4. Golden Circle Drive at First Street	E	AM	0.331	A	0.331	A	0.000	No	--	--
		PM	0.324	A	0.325	A	0.001	No	--	--
5. Tustin Avenue at First Street	D	AM	0.396	A	0.398	A	0.002	No	--	--
		PM	0.418	A	0.421	A	0.003	No	--	--
6. Yorba Street at First Street	D	AM	0.448	A	0.449	A	0.001	No	--	--
		PM	0.526	A	0.529	A	0.003	No	--	--
7. I-5 SB On Ramp/Mabury Street at 4 <sup>th</sup> Street	D	AM	0.357	A	0.382	A	0.025	No	--	--
		PM	0.395	A	0.399	A	0.004	No	--	--
8. I-5 NB Ramps at 4 <sup>th</sup> Street	D	AM	0.429	A	0.442	A	0.013	No	--	--
		PM	0.774	C	0.787	C	0.013	No	--	--
9. Cabrillo Park Drive at 4 <sup>th</sup> Street	E	AM	0.551	A	0.547	A	-0.004 <sup>13</sup>	No	--	--
		PM	0.714	C	0.793	C	0.079	No	--	--

Note:

- **Bold ICU/LOS or HCM/LOS** values indicate adverse service levels based on the Cities LOS standards.
- s/v = seconds per vehicle (delay)

<sup>13</sup> Negative V/C increase is due to Project-specific improvements as detailed in Section 11.0.



TABLE 8-1 (CONTINUED)  
EXISTING PLUS PROJECT PEAK HOUR INTERSECTION CAPACITY ANALYSIS

Key Intersection	Minimum Acceptable LOS	Time Period	(1) Existing Traffic Conditions		(2) Existing Plus Project Traffic Conditions		(3) Significant Impact		(4) Existing Plus Project Plus Improvements Traffic Conditions	
			ICU/HCM	LOS	ICU/HCM	LOS	Increase	Yes/No	ICU/HCM	LOS
10. Golden Circle Drive at 4 <sup>th</sup> Street	E	AM	0.398	A	0.410	A	0.012	No	--	--
		PM	0.405	A	0.421	A	0.016	No	--	--
11. Park Center Drive at 4 <sup>th</sup> Street	E	AM	13.7 s/v	B	14.0 s/v	B	0.3 s/v	No	--	--
		PM	16.2 s/v	C	17.0 s/v	C	0.8 s/v	No	--	--
12. Tustin Avenue at 4 <sup>th</sup> Street	E	AM	0.667	B	0.667	B	0.000	No	--	--
		PM	0.738	C	0.751	C	0.013	No	--	--
13. SR-55 SB Ramps at 4 <sup>th</sup> Street	D	AM	<b>0.978</b>	<b>E</b>	<b>0.991</b>	<b>E</b>	<b>0.013</b>	<b>Yes</b>	0.521	A
		PM	0.748	C	0.761	C	0.013	No	0.706	C
14. SR-55 NB Ramps at 4 <sup>th</sup> Street	D	AM	0.670	B	0.684	B	0.014	No	--	--
		PM	0.689	B	0.705	C	0.016	No	--	--
15. Yorba Street at 4 <sup>th</sup> Street	D	AM	0.561	A	0.563	A	0.002	No	--	--
		PM	0.605	B	0.610	B	0.005	No	--	--
16. Cabrillo Park Drive at State Fund Access Road	E	AM	0.308	A	0.319	A	0.011	No	--	--
		PM	0.340	A	0.347	A	0.007	No	--	--
17. Cabrillo Park Drive at Xerox Centre Access Road	E	AM	0.271	A	0.282	A	0.011	No	--	--
		PM	0.308	A	0.315	A	0.007	No	--	--
18. Cabrillo Park Drive at 17 <sup>th</sup> Street	D	AM	0.568	A	0.571	A	0.003	No	--	--
		PM	0.611	B	0.619	B	0.008	No	--	--

Note:

- **Bold ICU/LOS or HCM/LOS** values indicate adverse service levels based on the Cities LOS standards.
- s/v = seconds per vehicle (delay)

TABLE 8-1 (CONTINUED)  
EXISTING PLUS PROJECT PEAK HOUR INTERSECTION CAPACITY ANALYSIS

Key Intersection	Minimum Acceptable LOS	Time Period	(1) Existing Traffic Conditions		(2) Existing Plus Project Traffic Conditions		(3) Significant Impact		(4) Existing Plus Project Plus Improvements Traffic Conditions	
			ICU/HCM	LOS	ICU/HCM	LOS	Increase	Yes/No	ICU/HCM	LOS
19. Cabrillo Park Drive at Wellington Avenue	D	AM	17.8 s/v	C	18.2 s/v	C	0.4 s/v	No	--	--
		PM	17.9 s/v	C	18.3 s/v	C	0.4 s/v	No	--	--
20. Tustin Avenue at Wellington Avenue	E	AM	0.574	A	0.575	A	0.001	No	--	--
		PM	0.411	A	0.412	A	0.001	No	--	--
21. Mabury Street at Fruit Street	D	AM	7.7 s/v	A	7.7 s/v	A	0.0 s/v	No	--	--
		PM	7.7 s/v	A	7.7 s/v	A	0.0 s/v	No	--	--
22. Cabrillo Park Drive at Fruit Street	D	AM	12.5 s/v	B	12.7 s/v	B	0.2 s/v	No	--	--
		PM	11.5 s/v	B	11.9 s/v	B	0.4 s/v	No	--	--
23. Park Center Drive at Fruit Street	D	AM	10.3 s/v	B	10.4 s/v	B	0.1 s/v	No	--	--
		PM	10.5 s/v	B	10.6 s/v	B	0.1 s/v	No	--	--
24. Tustin Avenue at Fruit Street	E	AM	0.509	A	0.516	A	0.007	No	--	--
		PM	0.446	A	0.451	A	0.005	No	--	--
25. Cabrillo Park Drive at Park Court Place	D	AM	18.6 s/v	C	22.6 s/v	C	4.0 s/v	No	--	--
		PM	24.3 s/v	C	32.4 s/v	D	8.1 s/v	No	--	--

Note:

- **Bold ICU/LOS or HCM/LOS** values indicate adverse service levels based on the Cities LOS standards.
- s/v = seconds per vehicle (delay)

## 8.2 Year 2025 Traffic Conditions

**Table 8-2** summarizes the peak hour Level of Service results at the twenty-five (25) key study intersections for the Year 2025 horizon year. The first column (1) of ICU/LOS and HCM/LOS values in *Table 8-2* presents a summary of existing AM and PM peak hour traffic conditions. The second column (2) lists projected cumulative traffic conditions (existing plus ambient plus related projects traffic) based on existing intersection geometry, but without any traffic generated from the proposed Project. The third column (3) presents forecast Year 2025 near-term traffic conditions with the addition of Project traffic. The fourth column (4) shows the increase in ICU value and/or HCM value due to the added peak hour Project trips and indicates whether the traffic associated with the Project will have a significant impact based on the LOS standards and significant impact criteria defined in this report. The fifth column (5) presents the resultant level of service with the inclusion of recommended traffic improvements, where needed, to achieve an acceptable level of service.

### 8.2.1 Year 2025 Cumulative Traffic Conditions

Review of column (2) of *Table 8-2* indicates that the addition of ambient traffic growth and related projects traffic will adversely impact two (2) of the twenty-five key study intersections. The remaining study intersections are forecast to operate at acceptable level of service during the AM and PM peak hours. The intersections forecast to operate adversely consist of the following:

<u>Key Intersection</u>	<u>AM Peak Hour</u>		<u>PM Peak Hour</u>	
	<u>ICU/HCM</u>	<u>LOS</u>	<u>ICU/HCM</u>	<u>LOS</u>
1. Elk Lane at First Street	--	--	0.921	E
13. SR-55 SB Ramps at 4 <sup>th</sup> Street	1.063	F	--	--

### 8.2.2 Year 2025 Cumulative Plus Project Conditions

Review of columns (3) of *Table 8-2* indicates that four (4) of the twenty-five study intersections are forecast to operate at unacceptable level of service during the AM and/or PM peak hours, based on the LOS standards and impact criteria specified in this report, with the addition of project traffic. The remaining study intersections are forecast to operate at acceptable level of service during the AM and PM peak hours. The intersections forecast to operate adversely consist of the following:

<u>Key Intersection</u>	<u>AM Peak Hour</u>		<u>PM Peak Hour</u>	
	<u>ICU/HCM</u>	<u>LOS</u>	<u>ICU/HCM</u>	<u>LOS</u>
1. Elk Lane at First Street	--	--	0.929	E
8. I-5 NB Ramps at 4 <sup>th</sup> Street	--	--	0.904	E
13. SR-55 SB Ramps at 4 <sup>th</sup> Street	1.074	F	--	--
25. Cabrillo Park Drive at Park Court Place	--	--	45.9 s/v	E

Review of column (4) of *Table 8-2* indicates that two (2) intersections are significantly impacted by the Project under Year 2025 Cumulative Plus Project traffic conditions, which include I-5 NB Ramps/4<sup>th</sup> Street and SR-55 SB Ramps/4<sup>th</sup> Street. Review of column (5) indicates that the implementation of planned and/or recommended improvements at the intersections will help offset the Project's impact. Planned and recommended improvements are discussed in Section 11.0.

Although the intersection of Elk Lane/First Street operates adversely during the PM peak hour, the proposed Project adds less than 0.010 increment to the ICU value and is therefore not considered significantly impacted based on the LOS standards and impact criteria specified in this report.

Although Cabrillo Park Drive/Park Court Place operates adversely during the PM peak hour, a traffic signal is not warranted during the PM peak hour and therefore the intersection is not considered significantly impacted based on the LOS standards and impact criteria specified in this report. However, a traffic signal is warranted during the AM peak hour and therefore it is recommended to implement improvements at the intersection to help achieve acceptable level of service. Review of column (5) indicates that the installation of a two-phase traffic signal at this intersection would help improve the intersection and result in an acceptable level of service. It should be noted that the installation of a two-phase traffic signal would be in place of previously identified improvements at the intersection (i.e. median diverters to prohibit cross-traffic) as documented in the *Traffic Impact Study for the Metro East Overlay Zone in the City of Santa Ana*.

*Appendix D* also presents the near-term ICU/LOS and HCM/LOS calculations for the twenty-five (25) key study intersections. *Appendix H* presents the signal warrant worksheets for the intersection of Cabrillo Park Drive/Park Court Place.

TABLE 8-2  
YEAR 2025 CUMULATIVE PEAK HOUR INTERSECTION CAPACITY ANALYSIS

Key Intersection	Minimum Acceptable LOS	Time Period	(1) Existing Traffic Conditions		(2) Year 2025 Cumulative Traffic Conditions		(3) Year 2025 Cumulative Plus Project Traffic Conditions		(4) Significant Impact		(5) Year 2025 Cumulative Plus Project Plus Improvements Traffic Conditions	
			ICU/HCM	LOS	ICU/HCM	LOS	ICU/HCM	LOS	Increase	Yes/No	ICU/HCM	LOS
1. Elk Lane at First Street	D	AM	0.599	A	0.748	C	0.753	C	0.005	No	--	--
		PM	0.716	C	<b>0.921</b>	<b>E</b>	<b>0.929</b>	<b>E</b>	0.008	No	--	--
2. I-5 SB On Ramp at First Street	D	AM	0.425	A	0.517	A	0.527	A	0.010	No	--	--
		PM	0.584	A	0.681	B	0.691	B	0.010	No	--	--
3. Cabrillo Park Drive at First Street	E	AM	0.450	A	0.563	A	0.571	A	0.008	No	--	--
		PM	0.544	A	0.716	C	0.730	C	0.014	No	--	--
4. Golden Circle Drive at First Street	E	AM	0.331	A	0.384	A	0.385	A	0.001	No	--	--
		PM	0.324	A	0.381	A	0.382	A	0.001	No	--	--
5. Tustin Avenue at First Street	D	AM	0.396	A	0.487	A	0.489	A	0.002	No	--	--
		PM	0.418	A	0.476	A	0.478	A	0.002	No	--	--
6. Yorba Street at First Street	D	AM	0.448	A	0.524	A	0.525	A	0.001	No	--	--
		PM	0.526	A	0.610	B	0.613	B	0.003	No	--	--
7. I-5 SB On Ramp/Mabury Street at 4 <sup>th</sup> Street	D	AM	0.357	A	0.413	A	0.437	A	0.024	No	--	--
		PM	0.395	A	0.478	A	0.482	A	0.004	No	--	--
8. I-5 NB Ramps at 4 <sup>th</sup> Street	D	AM	0.429	A	0.482	A	0.495	A	0.013	No	0.495	A
		PM	0.774	C	0.891	D	<b>0.904</b>	<b>E</b>	<b>0.013</b>	<b>Yes</b>	0.573	A
9. Cabrillo Park Drive at 4 <sup>th</sup> Street	E	AM	0.551	A	0.633	B	0.620	B	-0.013 <sup>14</sup>	No	--	--
		PM	0.714	C	0.817	D	0.881	D	0.064	No	--	--

Note:

- **Bold ICU/LOS or HCM/LOS** values indicate adverse service levels based on the Cities LOS standards.
- s/v = seconds per vehicle (delay)

<sup>14</sup> Negative V/C increase is due to Project-specific improvements as detailed in Section 11.0.

TABLE 8-2 (CONTINUED)  
YEAR 2025 CUMULATIVE PEAK HOUR INTERSECTION CAPACITY ANALYSIS

Key Intersection	Minimum Acceptable LOS	Time Period	(1) Existing Traffic Conditions		(2) Year 2025 Cumulative Traffic Conditions		(3) Year 2025 Cumulative Plus Project Traffic Conditions		(4) Significant Impact		(5) Year 2025 Cumulative Plus Project Plus Improvements Traffic Conditions	
			ICU/HCM	LOS	ICU/HCM	LOS	ICU/HCM	LOS	Increase	Yes/No	ICU/HCM	LOS
10. Golden Circle Drive at 4 <sup>th</sup> Street	E	AM	0.398	A	0.447	A	0.459	A	0.012	No	--	--
		PM	0.405	A	0.469	A	0.483	A	0.014	No	--	--
11. Park Center Drive at 4 <sup>th</sup> Street	E	AM	13.7 s/v	B	15.6 s/v	C	15.8 s/v	C	0.2 s/v	No	--	--
		PM	16.2 s/v	C	20.9 s/v	C	22.2 s/v	C	1.3 s/v	No	--	--
12. Tustin Avenue at 4 <sup>th</sup> Street	E	AM	0.667	B	0.779	C	0.785	C	0.006	No	--	--
		PM	0.738	C	0.843	D	0.856	D	0.013	No	--	--
13. SR-55 SB Ramps at 4 <sup>th</sup> Street	D	AM	<b>0.978</b>	<b>E</b>	<b>1.063</b>	<b>F</b>	<b>1.074</b>	<b>F</b>	<b>0.011</b>	<b>Yes</b>	0.610	B
		PM	0.748	C	0.834	D	0.847	D	0.013	No	0.810	D
14. SR-55 NB Ramps at 4 <sup>th</sup> Street	D	AM	0.670	B	0.771	C	0.785	C	0.014	No	--	--
		PM	0.689	B	0.802	D	0.818	D	0.016	No	--	--
15. Yorba Street at 4 <sup>th</sup> Street	D	AM	0.561	A	0.614	B	0.616	B	0.002	No	--	--
		PM	0.605	B	0.664	B	0.668	B	0.004	No	--	--
16. Cabrillo Park Drive at State Fund Access Road	E	AM	0.308	A	0.347	A	0.359	A	0.012	No	--	--
		PM	0.340	A	0.386	A	0.393	A	0.007	No	--	--
17. Cabrillo Park Drive at Xerox Centre Access Road	E	AM	0.271	A	0.350	A	0.362	A	0.012	No	--	--
		PM	0.308	A	0.398	A	0.400	A	0.002	No	--	--
18. Cabrillo Park Drive at 17 <sup>th</sup> Street	D	AM	0.568	A	0.624	B	0.628	B	0.004	No	--	--
		PM	0.611	B	0.697	B	0.705	C	0.008	No	--	--

Note:

- **Bold ICU/LOS or HCM/LOS** values indicate adverse service levels based on the Cities LOS standards.
- s/v = seconds per vehicle (delay)

TABLE 8-2 (CONTINUED)  
YEAR 2025 CUMULATIVE PEAK HOUR INTERSECTION CAPACITY ANALYSIS

Key Intersection	Minimum Acceptable LOS	Time Period	(1) Existing Traffic Conditions		(2) Year 2025 Cumulative Traffic Conditions		(3) Year 2025 Cumulative Plus Project Traffic Conditions		(4) Significant Impact		(5) Year 2025 Cumulative Plus Project Plus Improvements Traffic Conditions	
			ICU/HCM	LOS	ICU/HCM	LOS	ICU/HCM	LOS	Increase	Yes/No	ICU/HCM	LOS
19. Cabrillo Park Drive at Wellington Avenue	D	AM	17.8 s/v	C	22.0 s/v	C	22.6 s/v	C	0.6 s/v	No	--	--
		PM	17.9 s/v	C	21.7 s/v	C	22.2 s/v	C	0.5 s/v	No	--	--
20. Tustin Avenue at Wellington Avenue	E	AM	0.574	A	0.612	B	0.613	B	0.001	No	--	--
		PM	0.411	A	0.443	A	0.445	A	0.002	No	--	--
21. Mabury Street at Fruit Street	D	AM	7.7 s/v	A	7.8 s/v	A	7.8 s/v	A	0.0 s/v	No	--	--
		PM	7.7 s/v	A	7.7 s/v	A	7.8 s/v	A	0.1 s/v	No	--	--
22. Cabrillo Park Drive at Fruit Street	D	AM	12.5 s/v	B	13.9 s/v	B	14.2 s/v	B	0.3 s/v	No	--	--
		PM	11.5 s/v	B	12.9 s/v	B	13.3 s/v	B	0.4 s/v	No	--	--
23. Park Center Drive at Fruit Street	D	AM	10.3 s/v	B	10.5 s/v	B	10.6 s/v	B	0.1 s/v	No	--	--
		PM	10.5 s/v	B	10.7 s/v	B	10.8 s/v	B	0.1 s/v	No	--	--
24. Tustin Avenue at Fruit Street	E	AM	0.509	A	0.543	A	0.550	A	0.007	No	--	--
		PM	0.446	A	0.480	A	0.485	A	0.005	No	--	--
25. Cabrillo Park Drive at Park Court Place	D	AM	18.6 s/v	C	21.4 s/v	C	26.6 s/v	D	5.9 s/v	No	0.487	A <sup>15</sup>
		PM	24.3 s/v	C	31.7 s/v	D	<b>45.9 s/v</b>	<b>E</b>	6.6 s/v	No	0.414	A <sup>15</sup>

Note:

- **Bold ICU/LOS or HCM/LOS** values indicate adverse service levels based on the Cities LOS standards.
- s/v = seconds per vehicle (delay)

<sup>15</sup> Although the intersection is not considered significantly impacted, it is forecast to operate at unacceptable level of service. Therefore, recommended mitigation measures have been included in this analysis for informational purposes. Recommended mitigation includes the installation of a two-phase traffic signal.

### 8.3 Year 2040 Traffic Conditions

**Table 8-3** summarizes the peak hour Level of Service results at the twenty-five (25) key study intersections for the Year 2040. The first column (1) of ICU/LOS and HCM/LOS values in *Table 8-3* presents a summary of existing AM and PM peak hour traffic conditions. The second column (2) lists projected Year 2040 long-term traffic conditions based on existing intersection geometry, but without any traffic generated from the proposed Project. The third column (3) presents forecast Year 2040 long-term traffic conditions with the addition of Project traffic. The fourth column (4) shows the increase in ICU value and/or HCM value due to the added peak hour Project trips and indicates whether the traffic associated with the Project will have a significant impact based on the LOS standards and significant impact criteria defined in this report. The fifth column (5) presents the resultant level of service with the inclusion of recommended traffic improvements, where needed, to achieve an acceptable level of service.

#### 8.3.1 Year 2040 Traffic Conditions

Review of column (2) of *Table 8-3* indicates that projected long-term (Year 2040) without project traffic will adversely impact four (4) of the twenty-five key study intersections. The remaining study intersections are forecast to operate at acceptable level of service during the AM and PM peak hours. The intersections forecast to operate adversely consist of the following:

<u>Key Intersection</u>	<u>AM Peak Hour</u>		<u>PM Peak Hour</u>	
	<u>ICU/HCM</u>	<u>LOS</u>	<u>ICU/HCM</u>	<u>LOS</u>
1. Elk Lane at First Street	--	--	0.964	E
8. I-5 NB Ramps at 4 <sup>th</sup> Street	--	--	0.960	E
13. SR-55 SB Ramps at 4 <sup>th</sup> Street	1.111	F	0.934	E
25. Cabrillo Park Drive at Park Court Place	--	--	37.2 s/v	E

#### 8.3.2 Year 2040 Plus Project Traffic Conditions

Review of columns (3) of *Table 8-3* indicates that four (4) of the twenty-five study intersections are forecast to operate at unacceptable level of service during the AM and/or PM peak hours, based on the LOS standards and impact criteria specified in this report, with the addition of project traffic. The remaining study intersections are forecast to operate at acceptable level of service during the AM and PM peak hours. The intersections forecast to operate adversely consist of the following:

<u>Key Intersection</u>	<u>AM Peak Hour</u>		<u>PM Peak Hour</u>	
	<u>ICU/HCM</u>	<u>LOS</u>	<u>ICU/HCM</u>	<u>LOS</u>
1. Elk Lane at First Street	--	--	0.972	E
8. I-5 NB Ramps at 4 <sup>th</sup> Street	--	--	0.973	E
13. SR-55 SB Ramps at 4 <sup>th</sup> Street	1.123	F	0.948	E
25. Cabrillo Park Drive at Park Court Place	--	--	56.9 s/v	F



Review of column (4) of *Table 8-3* indicates that two (2) intersections are significantly impacted by the Project under Year 2040 Buildout Plus Project traffic conditions, which include I-5 NB Ramps/4<sup>th</sup> Street and SR-55 SB Ramps/4<sup>th</sup> Street. Review of column (5) indicates that the implementation of planned and/or recommended improvements at the intersections will help offset the Project's impact. Planned and recommended improvements are discussed in Section 11.0.

Although the intersection of Elk Lane/First Street operates adversely during the PM peak hour, the proposed Project adds less than 0.010 increment to the ICU value and is therefore not considered significantly impacted based on the LOS standards and impact criteria specified in this report.

Although Cabrillo Park Drive/Park Court Place operates adversely during the PM peak hour, a traffic signal is not warranted during the PM peak hour and therefore the intersection is not considered significantly impacted based on the LOS standards and impact criteria specified in this report. However, a traffic signal is warranted during the AM peak hour and therefore it is recommended to implement improvements at the intersection to help achieve acceptable level of service. Review of column (5) indicates that the installation of a two-phase traffic signal at this intersection would help improve the intersection and result in an acceptable level of service. It should be noted that the installation of a two-phase traffic signal would be in place of previously identified improvements at the intersection (i.e. median diverters to prohibit cross-traffic) as documented in the *Traffic Impact Study for the Metro East Overlay Zone in the City of Santa Ana*.

*Appendix D* also presents the long-term ICU/LOS and HCM/LOS calculations for the twenty-five (25) key study intersections. *Appendix H* presents the signal warrant worksheets for the intersection of Cabrillo Park Drive/Park Court Place.

TABLE 8-3  
YEAR 2040 BUILDOUT PEAK HOUR INTERSECTION CAPACITY ANALYSIS

Key Intersection	Minimum Acceptable LOS	Time Period	(1) Existing Traffic Conditions		(2) Year 2040 Buildout Traffic Conditions		(3) Year 2040 Buildout Plus Project Traffic Conditions		(4) Significant Impact		(5) Year 2040 Buildout Plus Project Plus Improvements Traffic Conditions	
			ICU/HCM	LOS	ICU/HCM	LOS	ICU/HCM	LOS	Increase	Yes/No	ICU/HCM	LOS
1. Elk Lane at First Street	D	AM	0.599	A	0.785	C	0.791	A	0.006	No	--	--
		PM	0.716	C	<b>0.964</b>	<b>E</b>	<b>0.972</b>	<b>E</b>	0.008	No	--	--
2. I-5 SB On Ramp at First Street	D	AM	0.425	A	0.541	A	0.550	A	0.009	No	--	--
		PM	0.584	A	0.713	C	0.722	C	0.009	No	--	--
3. Cabrillo Park Drive at First Street	E	AM	0.450	A	0.652	B	0.660	B	0.008	No	--	--
		PM	0.544	A	0.750	C	0.764	C	0.014	No	--	--
4. Golden Circle Drive at First Street	E	AM	0.331	A	0.403	A	0.404	A	0.001	No	--	--
		PM	0.324	A	0.390	A	0.391	A	0.001	No	--	--
5. Tustin Avenue at First Street	D	AM	0.396	A	0.506	A	0.508	A	0.002	No	--	--
		PM	0.418	A	0.557	A	0.559	A	0.002	No	--	--
6. Yorba Street at First Street	D	AM	0.448	A	0.626	B	0.628	B	0.002	No	--	--
		PM	0.526	A	0.684	B	0.686	B	0.002	No	--	--
7. I-5 SB On Ramp/Mabury Street at 4 <sup>th</sup> Street	D	AM	0.357	A	0.432	A	0.457	A	0.025	No	--	--
		PM	0.395	A	0.503	A	0.517	A	0.014	No	--	--
8. I-5 NB Ramps at 4 <sup>th</sup> Street	D	AM	0.429	A	0.528	A	0.541	A	0.013	No	0.541	A
		PM	0.774	C	<b>0.960</b>	<b>E</b>	<b>0.973</b>	<b>E</b>	<b>0.013</b>	<b>Yes</b>	0.626	B
9. Cabrillo Park Drive at 4 <sup>th</sup> Street	E	AM	0.551	A	0.669	B	0.661	B	-0.008 <sup>16</sup>	No	--	--
		PM	0.714	C	0.846	D	0.915	E	0.069	No	--	--

Note:

- **Bold ICU/LOS or HCM/LOS** values indicate adverse service levels based on the Cities LOS standards.
- s/v = seconds per vehicle (delay)

<sup>16</sup> Negative V/C increase is due to Project-specific improvements as detailed in Section 11.0.

TABLE 8-3 (CONTINUED)  
YEAR 2040 BUILDOUT PEAK HOUR INTERSECTION CAPACITY ANALYSIS

Key Intersection	Minimum Acceptable LOS	Time Period	(1) Existing Traffic Conditions		(2) Year 2040 Buildout Traffic Conditions		(3) Year 2040 Buildout Plus Project Traffic Conditions		(4) Significant Impact		(5) Year 2040 Buildout Plus Project Plus Improvements Traffic Conditions	
			ICU/HCM	LOS	ICU/HCM	LOS	ICU/HCM	LOS	Increase	Yes/No	ICU/HCM	LOS
10. Golden Circle Drive at 4 <sup>th</sup> Street	E	AM	0.398	A	0.466	A	0.478	A	0.012	No	--	--
		PM	0.405	A	0.490	A	0.503	A	0.013	No	--	--
11. Park Center Drive at 4 <sup>th</sup> Street	E	AM	13.7 s/v	B	16.2 s/v	C	16.5 s/v	C	0.3 s/v	No	--	--
		PM	16.2 s/v	C	22.7 s/v	C	24.3 s/v	C	1.6 s/v	No	--	--
12. Tustin Avenue at 4 <sup>th</sup> Street	E	AM	0.667	B	0.820	D	0.826	D	0.006	No	--	--
		PM	0.738	C	0.961	E	0.961	E	0.000	No	--	--
13. SR-55 SB Ramps at 4 <sup>th</sup> Street	D	AM	<b>0.978</b>	<b>E</b>	<b>1.111</b>	<b>F</b>	<b>1.123</b>	<b>F</b>	<b>0.012</b>	<b>Yes</b>	0.635	B
		PM	0.748	C	<b>0.934</b>	<b>E</b>	<b>0.948</b>	<b>E</b>	<b>0.014</b>	<b>Yes</b>	<b>0.903</b>	<b>E</b>
14. SR-55 NB Ramps at 4 <sup>th</sup> Street	D	AM	0.670	B	0.835	D	0.849	D	0.014	No	--	--
		PM	0.689	B	0.851	D	0.890	D	0.039	No	--	--
15. Yorba Street at 4 <sup>th</sup> Street	D	AM	0.561	A	0.752	C	0.754	C	0.002	No	--	--
		PM	0.605	B	0.715	C	0.719	C	0.004	No	--	--
16. Cabrillo Park Drive at State Fund Access Road	E	AM	0.308	A	0.362	A	0.374	A	0.012	No	--	--
		PM	0.340	A	0.403	A	0.409	A	0.006	No	--	--
17. Cabrillo Park Drive at Xerox Centre Access Road	E	AM	0.271	A	0.366	A	0.377	A	0.011	No	--	--
		PM	0.308	A	0.408	A	0.417	A	0.009	No	--	--
18. Cabrillo Park Drive at 17 <sup>th</sup> Street	D	AM	0.568	A	0.652	B	0.655	B	0.003	No	--	--
		PM	0.611	B	0.730	C	0.737	C	0.007	No	--	--

Note:

- **Bold ICU/LOS or HCM/LOS** values indicate adverse service levels based on the Cities LOS standards.
- s/v = seconds per vehicle (delay)

TABLE 8-3 (CONTINUED)  
YEAR 2040 BUILDOUT PEAK HOUR INTERSECTION CAPACITY ANALYSIS

Key Intersection	Minimum Acceptable LOS	Time Period	(1) Existing Traffic Conditions		(2) Year 2040 Buildout Traffic Conditions		(3) Year 2040 Buildout Plus Project Traffic Conditions		(4) Significant Impact		(5) Year 2040 Buildout Plus Project Plus Improvements Traffic Conditions	
			ICU/HCM	LOS	ICU/HCM	LOS	ICU/HCM	LOS	Increase	Yes/No	ICU/HCM	LOS
19. Cabrillo Park Drive at Wellington Avenue	D	AM	17.8 s/v	C	24.4 s/v	C	25.2 s/v	D	0.8 s/v	No	--	--
		PM	17.9 s/v	C	24.1 s/v	C	24.7 s/v	C	0.6 s/v	No	--	--
20. Tustin Avenue at Wellington Avenue	E	AM	0.574	A	0.640	B	0.641	B	0.001	No	--	--
		PM	0.411	A	0.462	A	0.464	A	0.002	No	--	--
21. Mabury Street at Fruit Street	D	AM	7.7 s/v	A	7.8 s/v	A	7.8 s/v	A	0.0 s/v	No	--	--
		PM	7.7 s/v	A	7.8 s/v	A	7.9 s/v	A	0.1 s/v	No	--	--
22. Cabrillo Park Drive at Fruit Street	D	AM	12.5 s/v	B	14.9 s/v	B	15.2 s/v	C	0.3 s/v	No	--	--
		PM	11.5 s/v	B	13.6 s/v	B	14.0 s/v	B	0.4 s/v	No	--	--
23. Park Center Drive at Fruit Street	D	AM	10.3 s/v	B	10.7 s/v	B	10.8 s/v	B	0.1 s/v	No	--	--
		PM	10.5 s/v	B	10.8 s/v	B	12.0 s/v	B	1.2 s/v	No	--	--
24. Tustin Avenue at Fruit Street	E	AM	0.509	A	0.577	A	0.584	A	0.007	No	--	--
		PM	0.446	A	0.502	A	0.506	A	0.004	No	--	--
25. Cabrillo Park Drive at Park Court Place	D	AM	18.6 s/v	C	23.0 s/v	C	29.2 s/v	D	7.2 s/v	No	0.514	A <sup>17</sup>
		PM	24.3 s/v	C	<b>37.2 s/v</b>	<b>E</b>	<b>56.9 s/v</b>	<b>F</b>	9.1 s/v	No	0.423	A <sup>17</sup>

Note:

- **Bold ICU/LOS or HCM/LOS** values indicate adverse service levels based on the Cities LOS standards.
- s/v = seconds per vehicle (delay)

<sup>17</sup> Although the intersection is not considered significantly impacted, it is forecast to operate at unacceptable level of service. Therefore, recommended mitigation measures have been included in this analysis for informational purposes. Recommended mitigation includes the installation of a two-phase traffic signal.

## 9.0 STATE OF CALIFORNIA (CALTRANS) ANALYSIS

In conformance with the current Caltrans *Guide for the Preparation of Traffic Impact Studies, dated December 2002*, existing and projected peak hour operating conditions at the five (5) state-controlled study intersections within the study area have been evaluated using the *Highway Capacity Manual* operations method of analysis. These state-controlled locations include the following study intersections:

2. I-5 SB On-Ramp at First Street (City of Santa Ana/Caltrans)
7. I-5 SB On-Ramp/Mabury Street at 4<sup>th</sup> Street (City of Santa Ana/Caltrans)
8. I-5 NB Ramps at 4<sup>th</sup> Street (City of Santa Ana/Caltrans)
13. SR-55 SB Ramps at 4<sup>th</sup> Street (City of Santa Ana/Caltrans)
14. SR-55 NB Ramps at 4<sup>th</sup> Street (City of Tustin/Caltrans)

Caltrans “endeavors to maintain a target LOS at the transition between LOS “C” and LOS “D” on State highway facilities”; it does not require that LOS “D” (shall) be maintained. However, Caltrans acknowledges that this may not always be feasible and recommends that the lead agency consult with Caltrans to determine the appropriate target LOS. For this analysis, LOS D is the target level of service standard and will be utilized to assess the project impacts at the state-controlled study intersections.

The Caltrans *Guide for the Preparation of Traffic Impact Studies, dated December 2002* states that if an existing State-owned facility operates at less than the target LOS (i.e. LOS D); the existing service level should be maintained. Based on Caltrans Criteria, a Project’s impact is considered significant if the Project causes the LOS to change from an acceptable LOS (i.e., LOS D or better) to a deficient LOS (i.e. LOS E or F).

### 9.1 Highway Capacity Manual (HCM) Method of Analysis (Signalized Intersections)

Based on the HCM 6<sup>th</sup> Edition operations method of analysis, level of service for signalized intersections is defined in terms of control delay, which is a measure of driver discomfort, frustration, fuel consumption and lost travel time. The delay experienced by a motorist is made up of a number of factors that relate to control, geometries, traffic and incidents. Total delay is the difference between the travel time actually experienced and the reference travel time that would result during ideal conditions: in the absence of traffic control, in the absence of geometric delay, in the absence of any incidents and when there are no other vehicles on the road.

In the HCM, only the portion of total delay attributed to the control facility is quantified. This delay is called *control delay*. Control delay includes initial deceleration delay, queue move-up time, stopped delay and final acceleration delay. Specifically, LOS criteria for traffic signals are stated in terms of the average control delay per vehicle. The six qualitative categories of Level of Service that have been defined along with the corresponding HCM control delay value range for signalized intersections are shown in **Table 9-1**.

TABLE 9-1  
LEVEL OF SERVICE CRITERIA FOR SIGNALIZED INTERSECTIONS (HCM)<sup>18</sup>

Level of Service (LOS)	Control Delay Per Vehicle (seconds/vehicle)	Level of Service Description
A	$\leq 10.0$	This level of service occurs when progression is extremely favorable and most vehicles arrive during the green phase. Most vehicles do not stop at all. Short cycle lengths may also contribute to low delay.
B	$> 10.0$ and $\leq 20.0$	This level generally occurs with good progression, short cycle lengths, or both. More vehicles stop than with LOS A, causing higher levels of average delay.
C	$> 20.0$ and $\leq 35.0$	Average traffic delays. These higher delays may result from fair progression, longer cycle lengths, or both. Individual cycle failures may begin to appear at this level. The number of vehicles stopping is significant at this level, though many still pass through the intersection without stopping.
D	$> 35.0$ and $\leq 55.0$	Long traffic delays. At level D, the influence of congestion becomes more noticeable. Longer delays may result from some combination of unfavorable progression, long cycle lengths, or high v/c ratios. Many vehicles stop, and the proportion of vehicles not stopping declines. Individual cycle failures are noticeable.
E	$> 55.0$ and $\leq 80.0$	Very long traffic delays. This level is considered by many agencies (i.e. SANBAG) to be the limit of acceptable delay. These high delay values generally indicate poor progression, long cycle lengths, and high v/c ratios. Individual cycle failures are frequent occurrences.
F	$\geq 80.0$	Severe congestion. This level, considered to be unacceptable to most drivers, often occurs with over saturation, that is, when arrival flow rates exceed the capacity of the intersection. It may also occur at high v/c ratios below 1.0 with many individual cycle failures. Poor progression and long cycle lengths may also be major contributing factors to such delay levels.

<sup>18</sup> Source: *Highway Capacity Manual* (Signalized Intersections).

## 9.2 Existing Plus Project Traffic Conditions

**Table 9-2** summarizes the peak hour Level of Service results at the five (5) state-controlled study intersections for existing plus project traffic conditions. The first column (1) of HCM/LOS values in *Table 9-2* presents a summary of existing AM and PM peak hour traffic. The second column (2) lists existing plus project traffic conditions with current intersection geometry/lane configurations. The third column (3) shows the increase in delay value due to the added peak hour project trips and indicates whether the traffic associated with the Project will have a significant impact based on the significant impact criteria defined in this report. The fourth column (4) indicates the anticipated level of service with improvements, if any.

### 9.2.1 Existing Traffic Conditions

Review of column (1) of *Table 9-2* indicates that the intersection of SR-55 SB Ramps/4<sup>th</sup> Street currently operates at unacceptable LOS F in the AM peak hour. The remaining state-controlled study intersections currently operate at LOS C or better during the weekday AM and PM peak hours.

### 9.2.2 Existing Plus Project Traffic Conditions

Review of columns (2) and (3) of *Table 9-2* indicates that the intersection of SR-55 SB Ramps/4<sup>th</sup> Street will continue to operate at unacceptable LOS F in the AM peak hour with the addition of project traffic. The remaining state-controlled study intersections are forecast to operate at acceptable LOS C or better during the weekday AM and PM peak hours, with the addition of project traffic.

Although the intersection of SR-55 SB Ramps/4<sup>th</sup> Street is forecast to operate at unacceptable LOS F in the AM peak hour, the intersection is not considered significantly impacted when compared to the LOS standards and significant impact criteria specified in this report.

**Appendix E** presents the existing plus project HCM/LOS calculations for the state-controlled study intersections.

TABLE 9-2  
EXISTING PLUS PROJECT PEAK HOUR INTERSECTION CAPACITY ANALYSIS SUMMARY - CALTRANS

Key Intersection	Time Period	(1) Existing Traffic Conditions		(2) Existing Plus Project Traffic Conditions		(3) Significant Impact	(4) Existing Plus Project Traffic Conditions with Improvements	
		HCM	LOS	HCM	LOS	Yes/No	HCM	LOS
2. I-5 SB On Ramp at First Street	AM	7.2 s/v	A	7.4 s/v	A	No	--	--
	PM	7.2 s/v	A	7.4 s/v	A	No	--	--
7. I-5 SB On Ramp/Mabury Street at 4 <sup>th</sup> street	AM	15.2 s/v	B	16.1 s/v	B	No	--	--
	PM	13.3 s/v	B	14.3 s/v	B	No	--	--
8. I-5 NB Ramps at 4 <sup>th</sup> Street	AM	8.7 s/v	A	8.6 s/v	A	No	--	--
	PM	14.2 s/v	B	14.4 s/v	B	No	--	--
13. SR-55 SB Ramps at 4 <sup>th</sup> Street	AM	<b>147.9 s/v</b>	<b>F</b>	<b>151.8 s/v</b>	<b>F</b>	No	26.8 s/v	C <sup>19</sup>
	PM	27.2 s/v	C	27.6 s/v	C	No	24.8 s/v	C <sup>19</sup>
14. SR-55 NB Ramps at 4 <sup>th</sup> Street	AM	24.8 s/v	C	25.6 s/v	C	No	--	--
	PM	20.0 s/v	B	20.7 s/v	C	No	--	--

Note:

- **Bold HCM/LOS** values indicate adverse service levels based on the Caltrans LOS standards.
- s/v = seconds per vehicle (delay)

<sup>19</sup> Although the intersection is not considered a significant impact based on Caltrans criteria, level of service results at the intersection with the implementation of improvements discussed in Section 11.0 have been included for informational purposes.



### 9.3 Year 2025 Traffic Conditions

**Table 9-3** summarizes the peak hour Level of Service results at the at the five (5) state-controlled study intersections for the Year 2025 horizon year. The first column (1) of HCM/LOS values in *Table 9-3* presents a summary of existing AM and PM peak hour traffic conditions. The second column (2) lists future Year 2025 cumulative traffic conditions (existing plus ambient growth traffic plus cumulative projects traffic), without any traffic generated by the proposed Project. The third column (3) presents future forecast traffic conditions with the addition of traffic generated by the proposed Project. The fourth column (4) shows the increase in delay value due to the added peak hour project trips and indicates whether the traffic associated with the Project will have a significant impact based on the LOS standards and significant impact criteria defined in this report. The fifth column (5) indicates the anticipated level of service with improvements, if any.

#### 9.3.1 Year 2025 Cumulative Traffic Conditions

Review of Column (2) of *Table 9-3* indicates that the intersection of SR-55 SB Ramps/4<sup>th</sup> Street is forecast to operate at unacceptable LOS F in the AM peak hour. The remaining state-controlled study intersections are forecast to operate at LOS C or better during the weekday AM and PM peak hours.

#### 9.3.2 Year 2025 Cumulative Plus Project Traffic Conditions

Review of columns (3) and (4) of *Table 9-3* indicates that the intersection of SR-55 SB Ramps/4<sup>th</sup> Street will continue to operate at unacceptable LOS F in the AM peak hour with the addition of project traffic. The remaining state-controlled study intersections are forecast to operate at acceptable LOS C or better during the weekday AM and PM peak hours, with the addition of project traffic.

Although the intersection of SR-55 SB Ramps/4<sup>th</sup> Street is forecast to operate at unacceptable LOS F in the AM peak hour, the intersection is not considered significantly impacted when compared to the LOS standards and significant impact criteria specified in this report.

*Appendix E* presents the Year 2025 HCM/LOS calculations for the state-controlled study intersections.

TABLE 9-3

YEAR 2025 CUMULATIVE PEAK HOUR INTERSECTION CAPACITY ANALYSIS SUMMARY - CALTRANS

Key Intersection	Time Period	(1) Existing Traffic Conditions		(2) Year 2025 Cumulative Traffic Conditions		(3) Year 2025 Cumulative Plus Project Traffic Conditions		(4) Significant Impact Yes/No	(5) Year 2025 Cumulative Plus Project Traffic Conditions with Improvements	
		HCM	LOS	HCM	LOS	HCM	LOS		HCM	LOS
2. I-5 SB On Ramp at First Street	AM	7.2 s/v	A	7.7 s/v	A	8.0 s/v	A	No	--	--
	PM	7.2 s/v	A	8.3 s/v	A	8.6 s/v	A	No	--	--
7. I-5 SB On Ramp/Mabury Street at 4 <sup>th</sup> street	AM	15.2 s/v	B	15.6 s/v	B	16.4 s/v	B	No	--	--
	PM	13.3 s/v	B	14.8 s/v	B	15.6 s/v	B	No	--	--
8. I-5 NB Ramps at 4 <sup>th</sup> Street	AM	8.7 s/v	A	10.0 s/v	A	9.9 s/v	A	No	9.2 s/v	A <sup>20</sup>
	PM	14.2 s/v	B	20.6 s/v	C	21.2 s/v	C	No	11.9 s/v	B <sup>20</sup>
13. SR-55 SB Ramps at 4 <sup>th</sup> Street	AM	<b>147.9 s/v</b>	<b>F</b>	<b>156.9 s/v</b>	<b>F</b>	<b>160.7 s/v</b>	<b>F</b>	No	25.7 s/v	C <sup>20</sup>
	PM	27.2 s/v	C	31.4 s/v	C	32.8 s/v	C	No	26.0 s/v	C <sup>20</sup>
14. SR-55 NB Ramps at 4 <sup>th</sup> Street	AM	24.8 s/v	C	34.7 s/v	C	36.2 s/v	D	No	--	--
	PM	20.0 s/v	B	26.8 s/v	C	29.4 s/v	C	No	--	--

Note:

- **Bold HCM/LOS** values indicate adverse service levels based on the Caltrans LOS standards.
- s/v = seconds per vehicle (delay)

<sup>20</sup> Although the intersection is not considered a significant impact based on Caltrans criteria, level of service results at the intersection with the implementation of improvements discussed in Section 11.0 have been included for informational purposes.

## 9.4 Year 2040 Traffic Conditions

**Table 9-4** summarizes the peak hour Level of Service results at the at the five (5) state-controlled study intersections for the Year 2040 buildout year. The first column (1) of HCM/LOS values in *Table 9-4* presents a summary of existing AM and PM peak hour traffic conditions. The second column (2) lists future Year 2040 buildout traffic conditions, without any traffic generated by the proposed Project. The third column (3) presents future forecast traffic conditions with the addition of traffic generated by the proposed Project. The fourth column (4) shows the increase in delay value due to the added peak hour project trips and indicates whether the traffic associated with the Project will have a significant impact based on the LOS standards and significant impact criteria defined in this report. The fifth column (5) indicates the anticipated level of service with improvements, if any.

### 9.4.1 Year 2040 Buildout Traffic Conditions

Review of Column (2) of *Table 9-4* indicates that the intersection of SR-55 SB Ramps/4<sup>th</sup> Street is forecast to operate at unacceptable LOS F in the AM peak hour. The remaining state-controlled study intersections are forecast to operate at LOS C or better during the weekday AM and PM peak hours.

### 9.4.2 Year 2040 Buildout Plus Project Traffic Conditions

Review of columns (3) and (4) of *Table 9-4* indicates that the intersection of SR-55 SB Ramps/4<sup>th</sup> Street will continue to operate at unacceptable LOS F in the AM peak hour with the addition of project traffic. The remaining state-controlled study intersections are forecast to operate at acceptable LOS C or better during the weekday AM and PM peak hours, with the addition of project traffic.

Although the intersection of SR-55 SB Ramps/4<sup>th</sup> Street is forecast to operate at unacceptable LOS F in the AM peak hour, the intersection is not considered significantly impacted when compared to the LOS standards and significant impact criteria specified in this report.

*Appendix E* presents the Year 2040 HCM/LOS calculations for the state-controlled study intersections.

TABLE 9-4  
YEAR 2040 BUILDOUT PEAK HOUR INTERSECTION CAPACITY ANALYSIS SUMMARY - CALTRANS

Key Intersection	Time Period	(1) Existing Traffic Conditions		(2) Year 2040 Buildout Traffic Conditions		(3) Year 2040 Buildout Plus Project Traffic Conditions		(4) Significant Impact Yes/No	(5) Year 2040 Buildout Plus Project Traffic Conditions with Improvements	
		HCM	LOS	HCM	LOS	HCM	LOS		HCM	LOS
2. I-5 SB On Ramp at First Street	AM	7.2 s/v	A	7.9 s/v	A	8.1 s/v	A	No	--	--
	PM	7.2 s/v	A	8.9 s/v	A	9.2 s/v	A	No	--	--
7. I-5 SB On Ramp/Mabury Street at 4 <sup>th</sup> street	AM	15.2 s/v	B	16.6 s/v	B	17.6 s/v	B	No	--	--
	PM	13.3 s/v	B	16.8 s/v	B	17.4 s/v	B	No	--	--
8. I-5 NB Ramps at 4 <sup>th</sup> Street	AM	8.7 s/v	A	10.2 s/v	B	10.2 s/v	B	No	9.4 s/v	A <sup>21</sup>
	PM	14.2 s/v	B	28.1 s/v	C	29.1 s/v	C	No	13.8 s/v	B <sup>21</sup>
13. SR-55 SB Ramps at 4 <sup>th</sup> Street	AM	<b>147.9 s/v</b>	<b>F</b>	<b>170.3 s/v</b>	<b>F</b>	<b>174.1 s/v</b>	<b>F</b>	No	25.4 s/v	C <sup>21</sup>
	PM	27.2 s/v	C	39.7 s/v	D	41.7 s/v	D	No	32.2 s/v	C <sup>21</sup>
14. SR-55 NB Ramps at 4 <sup>th</sup> Street	AM	24.8 s/v	C	48.2 s/v	D	50.6 s/v	D	No	--	--
	PM	20.0 s/v	B	34.7 s/v	C	37.0 s/v	D	No	--	--

Note:

- **Bold HCM/LOS** values indicate adverse service levels based on the Caltrans LOS standards.
- s/v = seconds per vehicle (delay)

<sup>21</sup> Although the intersection is not considered a significant impact based on Caltrans criteria, level of service results at the intersection with the implementation of improvements discussed in Section 11.0 have been included for informational purposes.

10.0 SITE ACCESS AND INTERNAL CIRCULATION EVALUATION

10.1 Site Access

Access to the proposed Project will be provided via one (1) full access unsignalized driveway along Park Court Place and one (1) right in/out only driveway located along 4<sup>th</sup> Street.

**Table 10-1** summarizes the intersection level of service results for the two (2) proposed Project driveways under near-term (Year 2025) and long-term (Year 2040) traffic conditions at completion and full occupancy of the proposed Project. As shown, these key study intersections are forecast to operate at LOS D or better during the AM peak hour and PM peak hour.

**Appendix F** presents the near-term and long-term HCM/LOS calculations for the two (2) Project driveways.

10.2 Queuing Analysis

A queuing assessment has been completed to validate the driveway locations and egress from the site. In addition, as a result of the recommended improvements in Section 11.0, which identifies a second westbound right turn lane at I-5 NB Ramps/4<sup>th</sup> Street, the queueing analysis includes additional recommended improvements to help with existing congestion at Cabrillo Park Drive/4<sup>th</sup> Street. This evaluation is based on *Synchro 10.0 SimTraffic* 95<sup>th</sup> Percentile methodology.

10.2.1 Year 2040 Buildout Plus Project Traffic Conditions

**Table 10-2** presents the queueing analyses results for the AM and PM peak hours for Year 2040 Buildout Plus Project traffic conditions. Column (1) presents results for Year 2040 Buildout project traffic conditions and column (2) presents results for Year 2040 Buildout Plus Project traffic conditions with recommended improvements.

Based on field observation it is apparent that congestion occurs at Cabrillo Park Drive/4<sup>th</sup> Street as a result of vehicles trying to enter the westbound right-turn lane along 4<sup>th</sup> Street. Due to the recommended second westbound right-turn lane along 4<sup>th</sup> Street, additional improvements are recommended for the northbound approach at Cabrillo Park Drive/4<sup>th</sup> Street. The additional recommended improvements consist of the following:

- Add signage to the northbound direction along with lane line extensions to direct the motorist in the left turn lane that they can enter the inner right-turn lane for access to the I-5 NB Ramp. The northbound left/thru lane should have signage and lane extensions to direct the motorist to use the outer right-turn lane for access to the I-5 NB Ramp. These improvements are subject to the review and approval of the City of Santa Ana.

Review of Column (1) of *Table 10-2* indicates that the queues are generally adequate under Year 2040 Buildout Plus Project traffic conditions during both the AM and PM peak hours. However, the southbound right-turn lane at Cabrillo Park Drive/4<sup>th</sup> Street may exceed the storage provided. As an alternative, subject to review and approval of City staff, an option southbound through/right lane in

addition to the proposed southbound right-turn lane can be striped to provide additional queuing storage.

Review of Column (2) of *Table 10-2* indicates that with the implementation of improvements, the queues are generally adequate under Year 2040 Buildout Plus Project traffic conditions during both the AM and PM peak hours. However, the southbound right-turn lane at Cabrillo Park Drive/4<sup>th</sup> Street may exceed the storage provided. As an alternative, subject to review and approval of City staff, an option southbound through/right lane in addition to the proposed southbound right-turn lane can be striped to provide additional queuing storage. The implementation of the recommended improvements also helps to improve congestion and limit unnecessary weaving/merging of vehicles that need to enter the I-5 NB Ramp<sup>22</sup>.

However, in the event that Fourth Street experiences “spikes” in congestion during the weekday AM and PM peak hours, residents will very likely re-route themselves (self-monitor) and utilize the northern Driveway on Park Court Place instead of the driveway on Fourth Street. The intersections of Cabrillo Park Drive/Park Court Place and Cabrillo Park Drive/Fourth Street have enough capacity to accommodate the additional trips.

**Appendix G** presents the queuing worksheets for Year 2040 Buildout Plus Project traffic conditions.

---

<sup>22</sup> Level of service results at Cabrillo Park Drive/4<sup>th</sup> Street with Improvements:  
*Year 2040 Buildout Plus Project: AM Peak Hour: ICU 0.674, LOS B; PM Peak Hour: ICU 0.915, LOS E*

TABLE 10-1  
PROJECT DRIVEWAY PEAK HOUR INTERSECTION CAPACITY ANALYSIS

Key Intersection	Intersection Control	Time Period	(1) Year 2025 Cumulative Plus Project Traffic Conditions		(2) Year 2040 Buildout Plus Project Traffic Conditions	
			HCM	LOS	HCM	LOS
A. Project Driveway 1 at Park Court Place	One-Way Stop	AM	9.5 s/v	A	9.5 s/v	A
		PM	9.3 s/v	A	9.4 s/v	A
B. Project Driveway 2 at 4 <sup>th</sup> Street	One-Way Stop	AM	16.6 s/v	C	17.2 s/v	C
		PM	29.1 s/v	D	31.6 s/v	D

Notes:

- s/v = seconds per vehicle (delay)

TABLE 10-2  
YEAR 2040 BUILDOUT PEAK HOUR QUEUING ANALYSIS<sup>23</sup>

Key Study Intersection	Storage Provided (feet)	(1) Year 2040 Buildout Plus Project Traffic Conditions				(2) Year 2040 Buildout Plus Project Traffic Conditions with Improvements			
		AM Peak Hour		PM Peak Hour		AM Peak Hour		PM Peak Hour	
		Max. Queue/Min. Storage Required	Adequate Storage (Yes/No)	Max. Queue/Min. Storage Required	Adequate Storage (Yes/No)	Max. Queue/Min. Storage Required	Adequate Storage (Yes/No)	Max. Queue/Min. Storage Required	Adequate Storage (Yes/No)
8. I-5 NB Ramps at 4 <sup>th</sup> Street  <i>Westbound Through</i>	555'/215' <sup>24</sup>	196'	Yes	189'	Yes	204'	Yes	184'	Yes
	<i>Westbound Right-Turn</i>	555'/215' <sup>24</sup>	134'	Yes	171'	Yes	137'	Yes	188'
9. Cabrillo Park Drive at 4 <sup>th</sup> Street  <i>Southbound Right-Turn</i>	100'	210'	No <sup>25</sup>	162'	No	176'	No <sup>25</sup>	126'	No <sup>25</sup>
A. Project Driveway 1 at Park Court Place  <i>Northbound Left/Right-Turn</i>	90'	58'	Yes	56'	Yes	61'	Yes	60'	Yes
B. Project Driveway 2 at 4 <sup>th</sup> Street  <i>Southbound Right-Turn</i>	185'	68'	Yes	79'	Yes	61'	Yes	60'	Yes

<sup>23</sup> Queues are based on *SimTraffic* 95<sup>th</sup> Percentile methodology.

<sup>24</sup> A storage of 555-feet is provided under existing traffic conditions while a storage of 215-feet represents the distance between the limit line and the proposed project driveway.

<sup>25</sup> Please note that a right-turn storage is 100-feet with a 60-foot transition. Alternatively, subject to review and approval of City staff, an option southbound through/right lane in addition to the proposed southbound right-turn lane can be striped to provide additional queuing storage.



### 10.3 Internal Circulation Evaluation

Access to the site is proposed via a right-turn in/out driveway along 4<sup>th</sup> Street. Access for small service/delivery trucks (i.e. UPS, FedEx, and trash trucks) and passenger vehicles for the Project site have been evaluated. Our evaluation of the on-site circulation shown on the Project site plan was performed using the *Turning Vehicle Templates*, developed by Jack E. Leisch & Associates and *AutoTURN for AutoCAD* computer software that simulates turning maneuvers for various types of vehicles. **Figure 10-1** illustrates the turning movements required of a small delivery truck (SU-30) as it accesses the site from 4<sup>th</sup> Street. Review of *Figure 10-1* shows overall the turning movements are considered adequate.

After reviewing the design of Project Driveway 2 along 4<sup>th</sup> Street, it has been determined that the driveway throating is considered adequate.

### 10.4 Sight Distance Evaluation

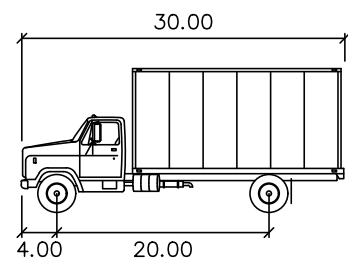
At intersections and/or project driveways, a substantially clear line of sight should be maintained between the driver of a vehicle waiting at the crossroad and the driver of an approaching vehicle. Adequate time must be provided for the waiting vehicle to either cross all lanes of through traffic, cross the near lanes and turn left, or turn right, without requiring through traffic to radically alter their speed. A sight distance evaluation has been performed for both project driveways.

The Sight Distance Evaluation prepared for the project driveways are based on the criteria and procedures set forth by the California Department of Transportation (Caltrans) in the State's *Highway Design Manual (HDM)*. Corner sight distance was utilized for the evaluation. Corner sight distance is defined in the Caltrans HDM to be the distance required by the driver of a vehicle, traveling at a given speed, to maneuver their vehicle and avoid an object without radically altering their speed. Line of sight for corner sight distance is to be determined from a 3½ foot height at the location of the driver of a vehicle on a minor road to a 4¼ foot object height in the center of the approaching lane of the major road.

Based on the criteria set forth in Table 405.1A of the Caltrans HDM and a posted speed limit of 25 mph on Park Court Place, a corner sight distance of 275 feet is required for left-turn at Project Driveway 1 and 239 feet for right-turn at Project Driveway 1.

Based on the criteria set forth in Table 405.1A of the Caltrans HDM and a posted speed limit of 40 mph on 4<sup>th</sup> Street, a corner sight distance of 382 feet is required for right-turn at Project Driveway 2.

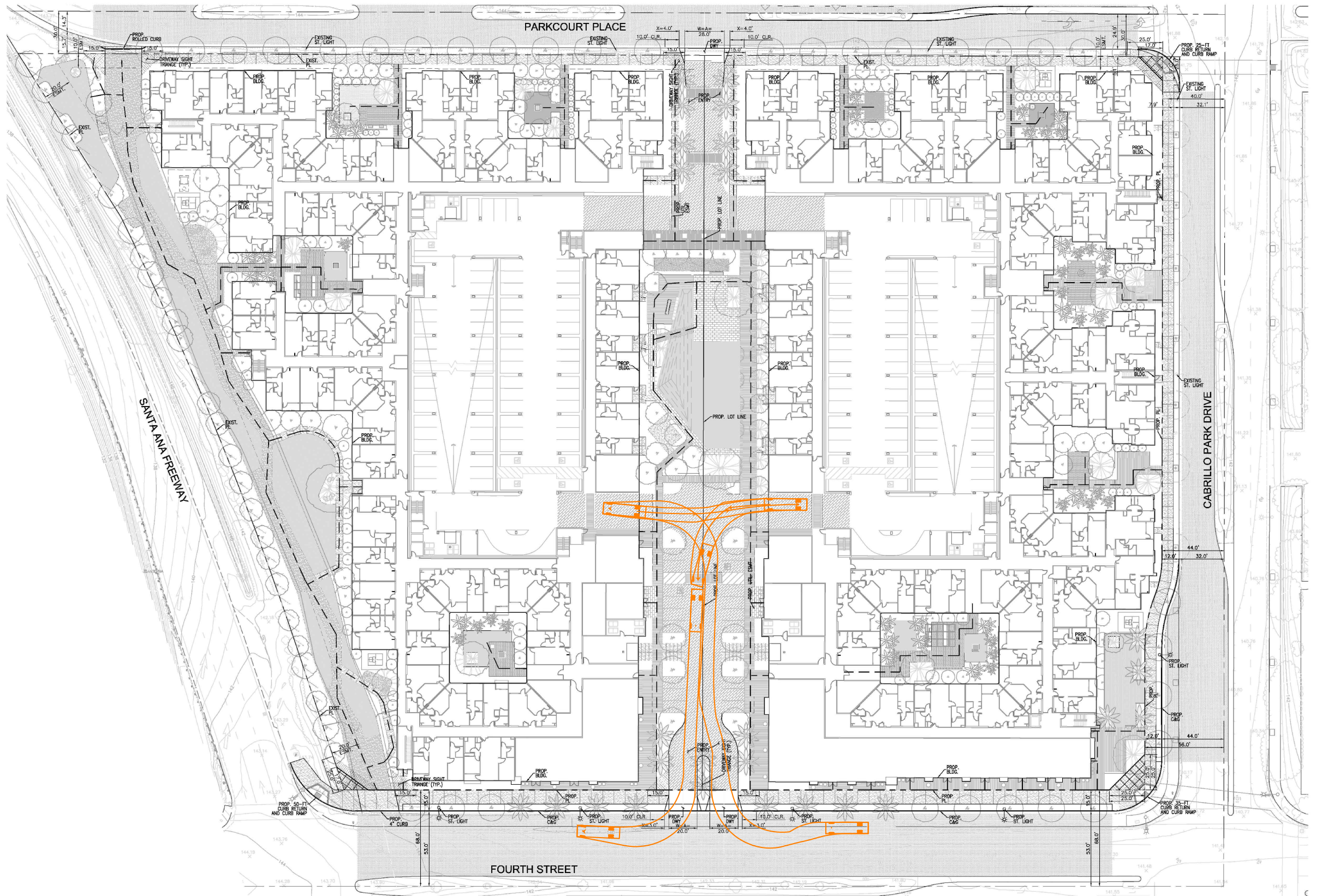
**Figure 10-2** presents the results of the sight distance evaluation for the Project driveways based on the application of the corner sight distance criteria. The figure illustrates the limited use areas. As shown, the sight lines at the proposed Project driveways are expected to be adequate as long as obstructions within the sight triangles are minimized.



SU

feet

- Width : 8.00
- Track : 8.00
- Lock to Lock Time : 6.0
- Steering Angle : 31.8



SOURCE: KTG ARCHITECTS

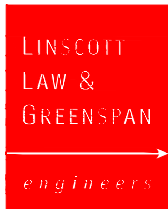



FIGURE 10-1

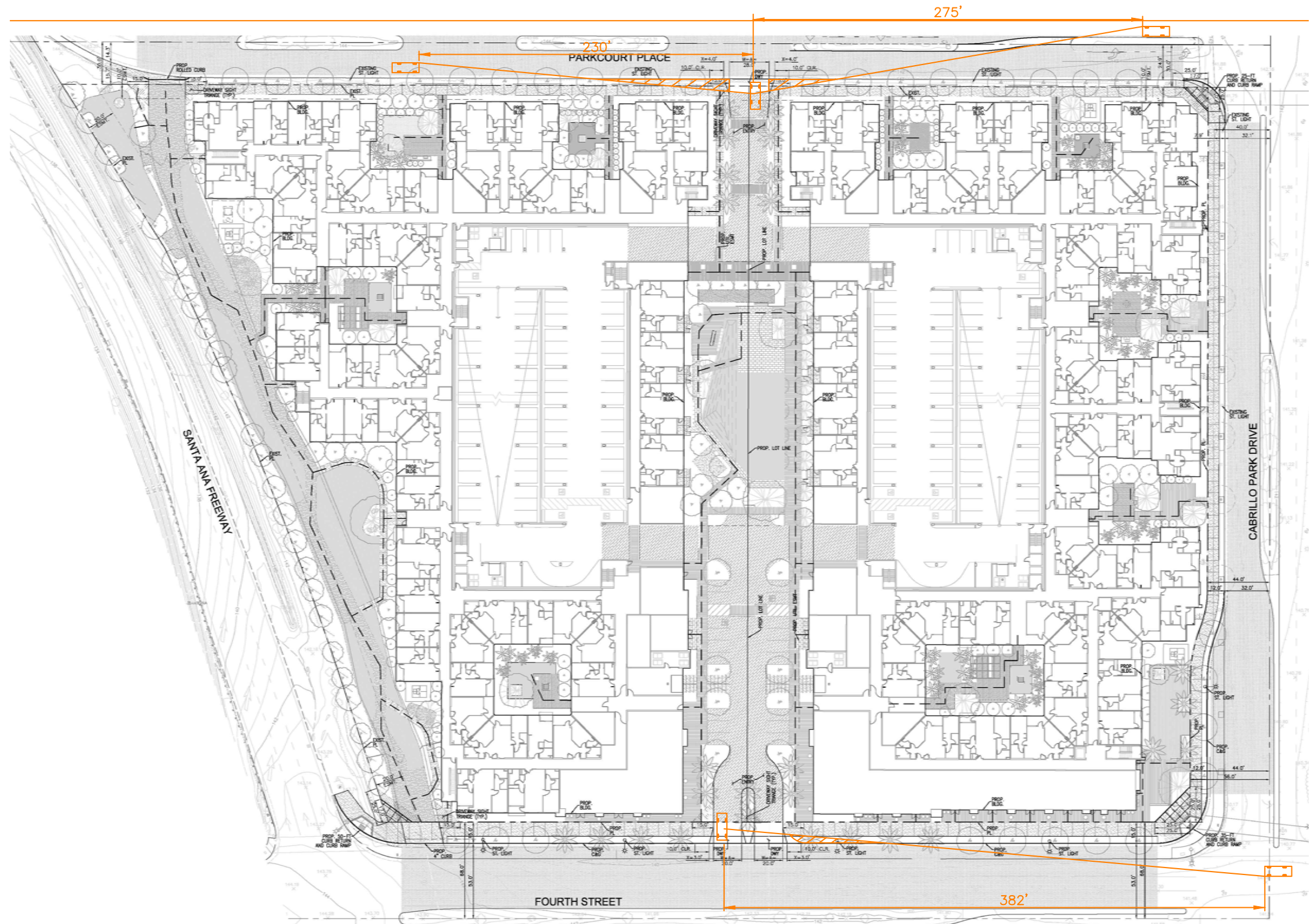
SU-30 TRUCK TURNING ANALYSIS  
4TH AND CABRILLO MIXED-USE PROJECT, SANTA ANA

**CORNER SIGHT DISTANCE**

DESIGN SPEED LIMIT:	25 MPH
REQUIRED CORNER SIGHT DISTANCE:	239 FEET
RIGHT TURN MOVEMENT	
DESIGN SPEED LIMIT:	25 MPH
REQUIRED CORNER SIGHT DISTANCE:	275 FEET
LEFT TURN MOVEMENT	
DESIGN SPEED LIMIT:	40 MPH
REQUIRED CORNER SIGHT DISTANCE:	382 FEET
RIGHT TURN MOVEMENT	

**LEGEND**

 LIMITED USE AREA: TO ENSURE ADEQUATE SIGHT DISTANCE, HARDSCAPE AND/OR LANDSCAPE SHALL NOT BE HIGHER THAN 30 INCHES. NO FENCES OR WALLS IN LIMITED USE AREA.



SOURCE: KTG ARCHITECTS



**FIGURE 10-2**

**PROJECT DRIVEWAYS SIGHT DISTANCE ANALYSIS**  
4TH AND CABRILLO MIXED-USE PROJECT, SANTA ANA

## 11.0 RECOMMENDED INTERSECTION IMPROVEMENTS

For those intersections where projected traffic volumes are expected to result in unacceptable operating conditions, this report recommends (identifies) improvement measures that change the intersection geometry to increase capacity. These capacity improvements involve roadway widening and/or re-striping to reconfigure (add lanes) to specific approaches of a key intersection. The identified improvements are expected to:

- mitigate the impact of existing traffic, Project traffic and future non-project (ambient traffic growth and cumulative project) traffic and
- improve Levels of Service to an acceptable range and/or to pre-project conditions.

### 11.1 Planned and/or Recommended Improvements

#### 11.1.1 Existing Plus Project Traffic Conditions

The results of the intersection capacity analyses presented previously in *Table 8-1* shows that the proposed Project is expected to have a significant impact at one (1) of the twenty-five (25) key study intersections under Existing Plus Project traffic conditions. As such, the following intersection improvements are recommended to mitigate the impacts of the proposed Project under these conditions.

- **No. 13 – SR-55 SB Ramps at Fourth Street:** Modify the eastbound shared through/right-turn lane to construct a free-right turn lane. Modify the existing traffic signal as necessary. This improvement is subject to the review and approval of the City of Santa Ana and Caltrans. Per City requirements, the Project may be expected to pay a fair-share/local fee to cover the Project's fair share of the full construction costs needed to implement these mitigation measures.

#### 11.1.2 Year 2025 Cumulative Plus Project Traffic Conditions

The results of the intersection capacity analyses presented previously in *Table 8-2* shows that the proposed Project is expected to have a significant impact at two (2) of the twenty-five (25) key study intersections under Year 2025 Cumulative Plus Project traffic conditions. As such, the following intersection improvements are recommended to mitigate the impacts of the proposed Project under these conditions.

**No. 8 – I-5 NB Ramps at Fourth Street:** Construct an additional westbound right-turn lane. Modify the existing traffic signal as necessary, inclusive any modifications to the traffic signal phasing. This improvement is consistent with the *Traffic Impact Study for the Metro East Overlay Zone in the City of Santa Ana*. This improvement is subject to the review and approval of the City of Santa Ana and Caltrans. The proposed Project is expected to pay the full construction cost needed to implement these mitigation measures, which are reflected in the Project site plan and is considered a “design feature”.

- **No. 13 – SR-55 SB Ramps at Fourth Street:** Same as those identified in Section 11.1.1 – Modify the eastbound shared through/right-turn lane to construct a free-right turn lane. Modify the existing traffic signal as necessary. This improvement is subject to the review and

approval of the City of Santa Ana and Caltrans. Per City requirements, the Project may be expected to pay a fair-share/local fee to cover the Project's fair share of the full construction costs needed to implement these mitigation measures.

#### 11.1.3 Year 2040 Buildout Plus Project Traffic Conditions

The results of the intersection capacity analyses presented previously in *Table 8-3* shows that the proposed Project is expected to have a significant impact at two (2) of the twenty-five (25) key study intersections under Year 2040 Buildout Plus Project traffic conditions. As such, the following intersection improvements are recommended to mitigate the impacts of the proposed Project under these conditions.

- **No. 8 – I-5 NB Ramps at Fourth Street:** *Same as those identified in Section 11.1.2* – Construct an additional westbound right-turn lane. Modify the existing traffic signal as necessary inclusive any modifications to the traffic signal phasing. This improvement is consistent with the *Traffic Impact Study for the Metro East Overlay Zone in the City of Santa Ana*. This improvement is subject to the review and approval of the City of Santa Ana and Caltrans. The proposed Project is expected to pay the full construction cost needed to implement these mitigation measures which are reflected in the Project site plan and is considered a “design feature”.
- **No. 13 – SR-55 SB Ramps at Fourth Street:** *Same as those identified in Sections 11.1.1 and 11.1.2* – Modify the eastbound shared through/right-turn lane to construct a free-right turn lane. Modify the existing traffic signal as necessary. This improvement is subject to the review and approval of the City of Santa Ana and Caltrans. Per City requirements, the Project may be expected to pay a fair-share/local fee to cover the Project's fair share of the full construction costs needed to implement these mitigation measures.

#### 11.2 Project-Specific Improvements

The following improvements are being implemented as part of the proposed Project, which the Project is expected to pay the full construction costs:

- **No. 9 – Cabrillo Park Drive at Fourth Street:** Construct an exclusive southbound right-turn lane. Modify the existing traffic signal as necessary. This improvement, which has been incorporated in the Project site plan as a Project “design feature” is subject to the review and approval of the City of Santa Ana.

As an alternative to the above mentioned improvement, subject to review and approval of City staff, an option southbound through/right lane in addition to the proposed southbound right-turn lane is proposed to minimize the southbound right-turning vehicles from impeding the through traffic.

#### 11.3 Recommended Circulation Enhancement

The following improvements are recommended to be implemented to enhance circulation within the Project Vicinity, thereby maintaining acceptable operating conditions:

- **No. 25 – Cabrillo Park Drive at Park Court Place:** Install two-phase traffic signal and implement all necessary signing and striping improvements. This improvement is subject to the review and approval of the City of Santa Ana.

*Figure 11-1* graphically illustrates the recommended and project specific improvements, as well as recommended circulation enhancements. *Figure 11-2* presents a conceptual improvement plan for 4<sup>th</sup> Street between the I-5 NB Ramps and Cabrillo Park Drive that illustrates recommended signage and striping to inform motorists of availability of lanes to access the I-5 NB ramps and/or continue on 4<sup>th</sup> Street. The improvements are consistent with those recommended in Section 10.2 of this report. Please note that the proposed Project may be expected to pay the full construction cost needed to implement the signage and striping for the proposed freeway wayfinding at 4<sup>th</sup> Street and Cabrillo Park Drive. However, it is assumed that the City and/or Caltrans will provide maintenance of these improvements.

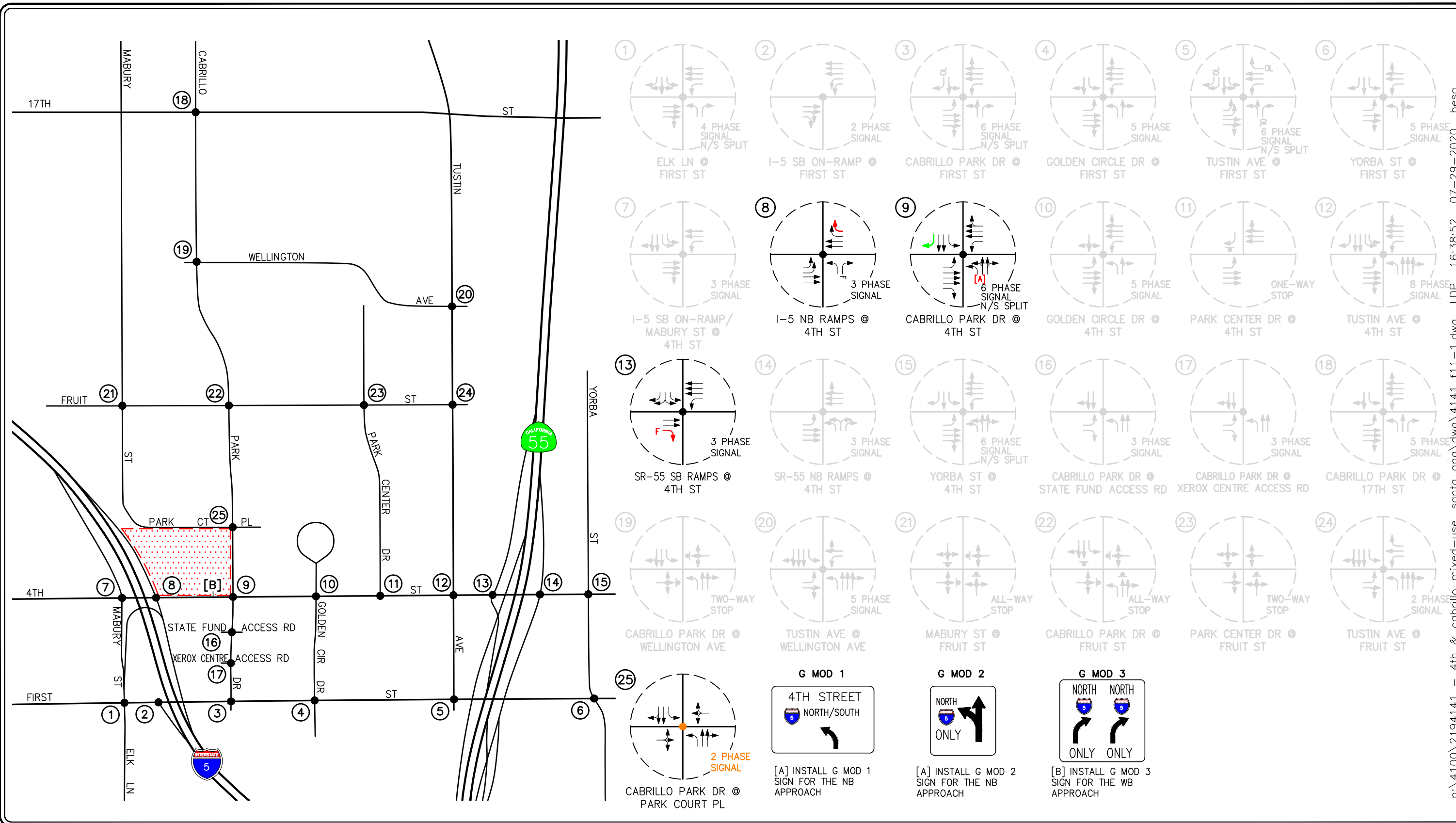
#### 11.4 Project-Related Fair-Share Contribution

The transportation impacts associated with the development of the Project were determined based on the Existing Plus Project, Year 2025 and Year 2040 Buildout traffic analyses. As summarized in *Tables 8-1, 8-2 and 8-3*, the development of the Project is anticipated to have a significant impact at two (2) locations. While the proposed Project is expected to pay the full construction costs for the intersection of I-5 NB Ramps/Fourth Street, the Project can be expected to pay its fair share of the improvement costs at the intersection of SR-55 SB Ramps/Fourth Street to offset the Project’s incremental traffic impact at these intersections.

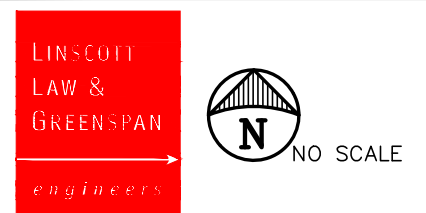
Although the intersection of Cabrillo Park Drive/Park Court Place is not considered significantly impacted, it was determined that the implementation of improvements at this location would help improve the level of service at this location, thereby enhancing access and circulation through this intersection for local area traffic as well as Project-related traffic. Therefore, based on collaboration with City staff, the proposed Project is expected to pay the full construction cost or install a traffic signal at this location.

*Table 11-1* presents the Project’s fair-share contribution to construct the recommended improvements at the two (2) study intersections. As presented in this *Table 11-1*, the first column (1) presents a total of all intersection peak hour movements for existing conditions. The second column (2) presents Project-related added traffic volumes during AM peak hour and PM peak hour. The third column (3) presents Year 2040 Buildout traffic conditions with Project traffic. The fourth column (4) represents what percentage of total added intersection peak hour traffic is Project-related traffic.

Review of *Table 11-1* shows that the proposed Project’s percentage of net traffic impact ranges from **12.30% to 100.00%**. This percentage represents the Project’s “fair-share” cost responsibility associated with the implementation of the recommended mitigation measures.



n:\41100\2194141 - 4th & cabrillo mixed-use, santa ana\dwg\4141 f11-1.dwg LDP 16:38:52 07-29-2020 besa



**KEY**

- Red arrow = RECOMMENDED IMPROVEMENT
- Green arrow = PROJECT SPECIFIC IMPROVEMENT
- Orange arrow = RECOMMENDED CIRCULATION ENHANCEMENT
- Red hatched box = PROJECT SITE

**FIGURE 11-1**

**PLANNED AND RECOMMENDED IMPROVEMENTS**  
4TH AND CABRILLO MIXED-USE PROJECT, SANTA ANA





TABLE 11-1  
YEAR 2040 BUILDOUT PROJECT FAIR-SHARE COST CONTRIBUTION

Key Intersection		City/ Jurisdiction	Time Period	(1) Existing Traffic	(2) Project Traffic	(3) Year 2040 Buildout Plus Project Traffic	(4) Project Fair-Share Percent <sup>26</sup>
13.	SR-55 SB Ramps at 4 <sup>th</sup> Street	Santa Ana/ Caltrans	AM	3163	78	3,797	12.30%
			PM	--	--	--	--
25.	Cabrillo Park Drive at Park Court Place	Santa Ana	AM	--	--	--	--
			PM	--	--	--	100.00% <sup>27</sup>

<sup>26</sup> Project fair-share percentage Column (4) = [Column (2)] / [Column (3) – Column (1)].

<sup>27</sup> As the intersection is not considered significantly impacted, the installation of the two-phase traffic signal shall be fully paid by the Project or the Project will implement the improvement. →

## 12.0 CONGESTION MANAGEMENT PROGRAM (CMP) COMPLIANCE ASSESSMENT

This analysis is consistent with the requirements and procedures outlined in the current *Orange County Congestion Management Program (CMP)*. The CMP requires that a traffic impact analysis be conducted for any project generating 2,400 or more daily trips, or 1,600 or more daily trips for projects that directly access the CMP Highway System (HS). As noted in Section 5.0 of this traffic study, the proposed Project is forecast to generate approximately 4,121 daily trip-ends and thus meets the criteria requiring a CMP TIA.

The CMPHS includes specific roadways, which include State Highways and Super Streets, which are now known as Smart Streets. Therefore, the CMP TIA analysis requirements relate to the potential impacts only on the specified CMPHS, which in this case includes First Street west of the I-5 SB On-Ramp. As described in the "Radius of Development Influence" section of the CMP TIA, the study area (i.e. CMP intersections) is recommended to be defined by the CMP links which have a project impact of three percent, or more, of their daily LOS "E" capacity.

There is one (1) CMP intersection in close proximity to the site which is as follows:

<u>Study Intersection</u>	<u>Location</u>
13	I-5 SB On-Ramps at First Street

**Table 12-1** summarizes the Project percentage impact CMP analysis for three (3) key roadway segments in the vicinity of the proposed Project along First Street. Column one (1) of *Table 12-1* shows the CMP LOS "E" Capacity for each roadway segment, column two (2) shows the Project ADT for each roadway segment, column three (3) shows the Project ADT LOS "E" capacity percentages for each roadway segment and column (4) shows whether or not added project traffic meets or exceeds the "three percent" limit.

Review of *Table 12-1* shows that the three percent limit is not exceeded at any of the three (3) key roadway segments and therefore a CMP analysis is not required.

TABLE 12-1  
PROJECT PERCENTAGE RADIUS OF INFLUENCE CMP ANALYSIS

<b>Roadway Segment</b>	<b>(1) CMP LOS "E" Capacity</b>	<b>(2) Project ADT</b>	<b>(3) Percentage (3) = (2) ÷ (1)</b>	<b>(4) Radius of Influence (Yes/No)</b>
1. First Street, west of Elk Lane/Mabury Street	56,300	206	0.4%	No
2. First Street, between Elk Lane/Mabury Street and I-5 SB On-Ramp	56,300	495	0.9%	No
3. First Street, between I-5 SB On-Ramp and Cabrillo Park Drive	56,300	515	0.9%	No

## 13.0 SUMMARY OF FINDINGS AND CONCLUSIONS

- **Project Description** – The Project site is an 8.35-acre vacant parcel of land within the Metro East Mixed Use Overlay Zone that is generally located north of 4<sup>th</sup> Street, east of the Santa Ana (I-5) freeway, and west of Cabrillo Park Drive.

The proposed Project includes the development of up to 644 apartment units, 3,500 SF restaurant uses and 11,700 SF of retail space. The proposed Project will provide a total of 1,300 parking spaces within two buildings along with 18 surface parking spaces. “Building A” is proposed as a five-story apartment podium with up to 325 apartment homes consisting of approximately 19 (±5.8%) studio units, 162 (±49.8%) one-bedroom units, 121 (±37.2%) two-bedroom units and 23 (±7.1%) three-bedroom units and approximately 6,100 SF of ground floor retail/commercial space and 3,500 SF restaurant space “wrapped” around an eight-level partial subterranean parking structure with a total of approximately 650 spaces along with 9 ground floor spaces for retail/leasing. “Building B” is proposed as a five-story apartment podium with up to 319 apartment homes consisting of approximately 20 (±6.3%) studio units, 164 (±51.4%) one-bedroom units, 127 (±39.8%) two-bedroom units and 8 (±2.5%) three-bedroom units and approximately 5,600 SF of ground floor retail/commercial space “wrapped” around an eight-level partial subterranean parking structure with a total of approximately 650 spaces along with 9 ground floor spaces for retail/leasing. On-site facilities/amenities of the proposed Project include a leasing office, a lounge/lobby, business center, pool/spa, and a fitness center for residents.

Vehicular access to the proposed Project will be provided via one (1) full access unsignalized driveway along Park Court Place and one (1) right in/out only driveway located along 4<sup>th</sup> Street. As part of the proposed Project, an exclusive southbound right-turn lane will be constructed at the intersection of Cabrillo Park Drive/4<sup>th</sup> Street. Additionally, the project’s curb face is planned to be set back far enough to accommodate improvements at I-5 NB Ramps/4<sup>th</sup> Street, which include the construction of an additional right-turn lane.

- **Study Scope** – The following twenty-five (25) key study intersections were selected for detailed peak hour level of service analyses under Existing Traffic Conditions, Existing Plus Project Traffic Conditions, Year 2025 Cumulative Traffic Conditions, Year 2025 Cumulative plus Project, Year 2040 Buildout Traffic Conditions, and Year 2040 Buildout Plus Project Traffic Conditions.

### Key Study Intersections

- |  |   |
|--|---|
| 1. Elk Lane at First Street (Santa Ana)                | 14. SR-55 NB Ramps at 4 <sup>th</sup> Street (Tustin/Caltrans)  |
| 2. I-5 SB On-Ramp at First Street (Santa Ana/Caltrans) | 15. Yorba Street at 4 <sup>th</sup> Street (Tustin)             |
| 3. Cabrillo Park Drive at First Street (Santa Ana)     | 16. Cabrillo Park Drive at State Fund Access Road (Santa Ana)   |
| 4. Golden Circle Drive at First Street (Santa Ana)     | 17. Cabrillo Park Drive at Xerox Center Access Road (Santa Ana) |
| 5. Tustin Avenue at First Street (Tustin)              | 18. Cabrillo Park Drive at 17 <sup>th</sup> Street (Santa Ana)  |
| 6. Yorba Street at First Street (Tustin)               | 19. Cabrillo Park Drive at Wellington Avenue (Santa Ana)        |

- |  |   |
|--|---|
| 7. I-5 SB On-Ramp/Mabury Street at 4 <sup>th</sup> Street (Santa Ana/Caltrans) | 20. Tustin Avenue at Wellington Avenue (Santa Ana)      |
| 8. I-5 NB Ramps at 4 <sup>th</sup> Street (Santa Ana/Caltrans)                 | 21. Mabury Street at Fruit Street (Santa Ana)           |
| 9. Cabrillo Park Drive at 4 <sup>th</sup> Street (Santa Ana)                   | 22. Cabrillo Park Drive at Fruit Street (Santa Ana)     |
| 10. Golden Circle Drive at 4 <sup>th</sup> Street (Santa Ana)                  | 23. Park Center Drive at Fruit Street (Santa Ana)       |
| 11. Park Center Drive at 4 <sup>th</sup> Street (Santa Ana)                    | 24. Tustin Avenue at Fruit Street (Santa Ana)           |
| 12. Tustin Avenue at 4 <sup>th</sup> Street (Santa Ana)                        | 25. Cabrillo Park Drive at Park Court Place (Santa Ana) |
| 13. SR-55 SB Ramps at 4 <sup>th</sup> Street (Santa Ana/Caltrans)              |   |

- **Existing Traffic Conditions** – Twenty-four (24) of the twenty-five key study intersections currently operate at an acceptable level of service during the AM and PM peak hours. The intersection of SR-55 SB Ramps/4<sup>th</sup> Street currently operates at unacceptable LOS E during the AM peak hour.
- **Project Trip Generation** – The proposed Project, after adjustment for internal capture, is forecast to generate approximately 4,121 “net” daily trips, with 264 “net” trips (82 inbound, 182 outbound) produced in the AM peak hour and 344 “net” trips (205 inbound, 139 outbound) produced in the PM peak hour on a “typical” weekday.
- **Related Projects Traffic Characteristics** – Thirty (30) related projects were considered as part of the cumulative background setting. The thirty (30) related projects are forecast to generate 45,942 daily trips, with 3,033 trips (1,458 inbound, 1,575 outbound) anticipated during the AM peak hour and 3,837 trips (1,927 inbound, 1,910 outbound) produced during the PM peak hour.
- **Existing Plus Project Traffic Conditions** – Traffic associated with the proposed Project will significantly impact one (1) of the twenty-five study intersections, when compared to the LOS standards and significant impact criteria specified in this report. The impacted intersection of SR-55 SB Ramps/4<sup>th</sup> Street is forecast to operate at LOS E during the AM peak hour. The remaining study intersections are forecast to operate at acceptable level of service during the AM and PM peak hours. The implementation of recommended improvements at the intersection will help offset the Project’s impact
- **Year 2025 Cumulative Traffic Conditions Plus Project** – Traffic associated with the proposed Project will significantly impact two (2) of the twenty-five study intersections, when compared to the LOS standards and significant impact criteria specified in this report, which include I-5 NB Ramps/4<sup>th</sup> Street and SR-55 SB Ramps/4<sup>th</sup> Street. The remaining study intersections are forecast to operate at acceptable level of service during the AM and PM peak hours. The implementation of recommended improvements at the intersection will help offset the Project’s impact.
- **Year 2040 Buildout Traffic Conditions Plus Project** – Traffic associated with the proposed Project will significantly impact two (2) of the twenty-five study intersections, when compared to the LOS standards and significant impact criteria specified in this report, which include I-5 NB Ramps/4<sup>th</sup> Street and SR-55 SB Ramps/4<sup>th</sup> Street. The remaining study intersections are

forecast to operate at acceptable level of service during the AM and PM peak hours. The implementation of recommended improvements at the intersection will help offset the Project's impact.

- **Caltrans Existing Traffic Conditions** – The intersection of SR-55 SB Ramps/4<sup>th</sup> Street currently operates at unacceptable LOS F in the AM peak hour. The remaining state-controlled study intersections currently operate at LOS C or better during the weekday AM and PM peak hours.
- **Caltrans Existing Plus Project Traffic Conditions** – The intersection of SR-55 SB Ramps/4<sup>th</sup> Street will continue to operate at unacceptable LOS F in the AM peak hour with the addition of project traffic. The remaining state-controlled study intersections are forecast to operate at acceptable LOS C or better during the weekday AM and PM peak hours, with the addition of project traffic.

Although the intersection of SR-55 SB Ramps/4<sup>th</sup> Street is forecast to operate at unacceptable LOS F in the AM peak hour, the intersection is not considered significantly impacted when compared to the LOS standards and significant impact criteria specified in this report.

- **Caltrans Year 2025 Cumulative Plus Project Traffic Conditions** – The intersection of SR-55 SB Ramps/4<sup>th</sup> Street will continue to operate at unacceptable LOS F in the AM peak hour with the addition of project traffic. The remaining state-controlled study intersections are forecast to operate at acceptable LOS C or better during the weekday AM and PM peak hours, with the addition of project traffic.

Although the intersection of SR-55 SB Ramps/4<sup>th</sup> Street is forecast to operate at unacceptable LOS F in the AM peak hour, the intersection is not considered significantly impacted when compared to the LOS standards and significant impact criteria specified in this report.

- **Caltrans Year 2040 Buildout Plus Project Traffic Conditions** – The intersection of SR-55 SB Ramps/4<sup>th</sup> Street will continue to operate at unacceptable LOS F in the AM peak hour with the addition of project traffic. The remaining state-controlled study intersections are forecast to operate at acceptable LOS C or better during the weekday AM and PM peak hours, with the addition of project traffic.

Although the intersection of SR-55 SB Ramps/4<sup>th</sup> Street is forecast to operate at unacceptable LOS F in the AM peak hour, the intersection is not considered significantly impacted when compared to the LOS standards and significant impact criteria specified in this report.

- **Queuing Analysis** – Based on field observation it is apparent that congestion occurs at Cabrillo Park Drive/4<sup>th</sup> Street as a result of vehicles trying to enter the westbound right-turn lane along 4<sup>th</sup> Street. Due to the recommended second westbound right-turn lane along 4<sup>th</sup> Street, additional improvements are recommended for the northbound and southbound approaches at Cabrillo Park Drive/4<sup>th</sup> Street. The additional recommended improvements consist of the following:

- Add signage to the northbound direction along with lane line extensions to direct the motorist in the left turn lane that they can enter the inner right-turn lane for access to the I-5 NB Ramp. The northbound left/thru lane should have signage and lane extensions to direct the motorist to use the outer right-turn lane for access to the I-5 NB Ramp. These improvements are subject to the review and approval of the City of Santa Ana.

With the implementation of improvements, the queues are generally adequate under Year 2040 Buildout Plus Project traffic conditions during both the AM and PM peak hours. However, the southbound right-turn lane at Cabrillo Park Drive/4<sup>th</sup> Street may exceed the storage provided. As an alternative, subject to review and approval of City staff, an option southbound through/right lane in addition to the proposed southbound right-turn lane can be striped to provide additional queuing storage. The implementation of the recommended improvements also helps to improve congestion and limit unnecessary weaving/merging of vehicles that need to enter the I-5 NB Ramp.

However, in the event that Fourth Street experiences “spikes” in congestion during the weekday AM and PM peak hours, residents will very likely re-route themselves (self-monitor) and utilize the northern Driveway on Park Court Place instead of the driveway on Fourth Street. The intersections of Cabrillo Park Drive/Park Court Place and Cabrillo Park Drive/Fourth Street have enough capacity to accommodate the additional trips.

- ***Existing Plus Project Recommended Improvements*** – The following intersection improvements are recommended to mitigate the impacts of the proposed Project under these conditions.
  - **No. 13 – SR-55 SB Ramps at Fourth Street:** Modify the eastbound shared through/right-turn lane to construct a free-right turn lane. Modify the existing traffic signal as necessary. This improvement is subject to the review and approval of the City of Santa Ana and Caltrans. Per City requirements, the Project may be expected to pay a fair-share/local fee to cover the Project’s fair share of the full construction costs needed to implement these mitigation measures.
- ***Year 2025 Cumulative Plus Project Recommended Improvements*** – The following intersection improvements are recommended to mitigate the impacts of the proposed Project under these conditions.
  - **No. 8 – I-5 NB Ramps at Fourth Street:** Construct an additional westbound right-turn lane. Modify the existing traffic signal as necessary inclusive any modifications to the traffic signal phasing. This improvement is consistent with the *Traffic Impact Study for the Metro East Overlay Zone in the City of Santa Ana*. This improvement is subject to the review and approval of the City of Santa Ana and Caltrans. The proposed Project is expected to pay the full construction cost needed to implement these mitigation measures.
  - **No. 13 – SR-55 SB Ramps at Fourth Street:** Modify the eastbound shared through/right-turn lane to construct a free-right turn lane. Modify the existing traffic signal as necessary.

This improvement is subject to the review and approval of the City of Santa Ana and Caltrans. Per City requirements, the Project may be expected to pay a fair-share/local fee to cover the Project's fair share of the full construction costs needed to implement these mitigation measures.

- ***Year 2040 Buildout Plus Project Recommended Improvements*** – The following intersection improvements are recommended to mitigate the impacts of the proposed Project under these conditions.
  - **No. 8 – I-5 NB Ramps at Fourth Street:** Construct an additional westbound right-turn lane. Modify the existing traffic signal as necessary inclusive any modifications to the traffic signal phasing. This improvement is consistent with the *Traffic Impact Study for the Metro East Overlay Zone in the City of Santa Ana*. This improvement is subject to the review and approval of the City of Santa Ana and Caltrans. The proposed Project is expected to pay the full construction cost needed to implement these mitigation measures.
  - **No. 13 – SR-55 SB Ramps at Fourth Street:** Modify the eastbound shared through/right-turn lane to construct a free-right turn lane. Modify the existing traffic signal as necessary. This improvement is subject to the review and approval of the City of Santa Ana and Caltrans. Per City requirements, the Project may be expected to pay a fair-share/local fee to cover the Project's fair share of the full construction costs needed to implement these mitigation measures.
- ***Project Specific Improvements*** – The following improvements are being implemented as part of the proposed Project, which the Project is expected to pay the full construction costs:
  - **No. 9 – Cabrillo Park Drive at Fourth Street:** Construct an exclusive southbound right-turn lane. Modify the existing traffic signal as necessary. This improvement is subject to the review and approval of the City of Santa Ana.

As an alternative to the above mentioned improvement, subject to review and approval of City staff, an option southbound through/right lane in addition to the proposed southbound right-turn lane is proposed to minimize the southbound right-turning vehicles from impeding the through traffic.

- ***Recommended Circulation Enhancement:*** The following improvements, which are expected to be implemented or paid for by the Project, are recommended to be implemented to enhance circulation within the Project Vicinity, thereby maintaining acceptable operating conditions:
  - **No. 25 – Cabrillo Park Drive at Park Court Place:** Install two-phase traffic signal and implement all necessary signing and striping improvements. This improvement is subject to the review and approval of the City of Santa Ana.



- ***Project-Related Fair-Share Contribution*** – The proposed Project’s percentage of net traffic impact ranges from **12.30%** to **100.00%**. This percentage represents the Project’s “fair-share” cost responsibility associated with the implementation of the recommended mitigation measures.
- ***CMP Compliance Assessment*** – The three percent limit is not exceeded at any of the three (3) key roadway segments and therefore a CMP analysis is not required.

# EXHIBIT **13**

1 - 215



## THE CONCORD GROUP

369 SAN MIGUEL DRIVE, SUITE 265  
NEWPORT BEACH, CALIFORNIA 92660  
PHONE 949.717.6450

251 KEARNY STREET, 6<sup>TH</sup> FLOOR  
SAN FRANCISCO, CALIFORNIA 94108  
PHONE 415.397.5490

1170 PEACHTREE STREET NE, SUITE 1200  
ATLANTA, GEORGIA 30309  
PHONE 404.879.5000

641 LEXINGTON AVENUE, SUITE 1400  
NEW YORK, NEW YORK 10022  
PHONE 646.354.7090

MARKET & FISCAL IMPACT ANALYSES  
FOR A MIXED-USE DEVELOPMENT IN  
SANTA ANA, CA (4<sup>TH</sup> & CABRILLO PARK DRIVE)

SPR No. 2020-04  
1801 East Fourth Street  
Central Pointe Mixed-Use Development  
Exhibit 13 – Market and Fiscal Analysis

PREPARED FOR:  
ARNEL DEVELOPMENT CO.



## TABLE OF CONTENTS

### EXECUTIVE SUMMARY

#### MARKET ANALYSIS

1. Recommendations
2. MF Rent Positioning
  - A. Rent to Size Graph
  - B. Absolute Rent
3. Retail / Office Rent Positioning
4. Project Location
  - A. Regional
  - B. Median Income
  - C. Local Setting
  - D. Surrounding Land Uses
  - E. Traffic Counts
5. Site Plan
6. Demographics
7. MF Macro-Market Performance
  - A. Inventory & Deliveries
  - B. Occupancy & Rents
8. MF Inventory
  - A. Location & Performance
  - B. Vacancy by Unit Type
  - C. Floor Plan Mix
  - D. Amenities
9. Retail Performance
10. Office Performance
11. Mixed-Use Analogs

### FISCAL IMPACT ANALYSIS

#### APPENDIX

- A. Survey – Apartments
- B. Survey – Retail Leases
- C. ULI – Emerging Trends in Real Estate

# EXECUTIVE SUMMARY



---

**To:** Arnel Development Co.  
**From:** The Concord Group  
**Date:** August 2020  
**Re:** Market & Fiscal Impact Analyses for a Mixed-Use Development in Santa Ana, CA (4<sup>th</sup> & Cabrillo Park Dr)

---

Arnel Development Co. (“Arnel”) is evaluating the development potential of a mixed-use project in the central Orange County community of Santa Ana. The project site is located at the eastern edge of the city, immediately opposite Interstate 5. The project is planned for 644 upscale apartment units and 15,200 square feet of commercial space, in a five-story building. In support of strategic planning and underwriting due diligence, Arnel required market and fiscal impact input to identify the highest and best use of the project under the current MEMU zoning and demonstrate the financial viability of the development. To this end, The Concord Group (“TCG”) and RSG were engaged to conduct market and fiscal feasibility analyses for the project. The following text highlights the key findings and conclusions generated by the analysis, supported by an exhibit package of tables, maps and graphs.

### Project Overview

- The project is well located near Interstate 5, Southern California’s primary north / south connector, and is just over a mile from the city’s Downtown and associated food, dining, service and employment amenities (*Exhibit 4*).
- A total of 644 apartments are planned in a five-story building with 15,200 square feet of ground floor retail, located at the northwest corner of 4<sup>th</sup> Street and Cabrillo Park Drive (*Exhibits 1 and 5*).
- The project’s elevated regional accessibility, close proximity to Downtown’s cultural amenities and major County job nodes, combined with a top-of-market community amenity and interior unit specification package, merits a near top-of-market multi-family rent positioning strategy (*Exhibit 2*).
- The scale of the commercial retail planned within the project’s mixed-use context is in alignment with other multi-family focused mixed-use projects in Orange County, who’s commercial retail footprints range from 8,500 to 14,000 SF (*Exhibit 11*).

## THE CONCORD GROUP

### Marketability

The project's marketing strengths are as follows:

- *Regional Accessibility* – the project site is easily accessible to the target renter and consumer base, with freeway and rail access each less than a mile away (*Exhibit 4C*).
- *Proximity to Jobs* – several major Orange County office employment nodes are within a five-mile radius of the project, including Downtown Santa Ana, South Coast Metro, Irvine Business Complex and Town and Country, driving demand for both apartments and commercial space.
- *Cultural and Entertainment Amenities* – the Project is located proximate to the city's Downtown and Artists Village, home to numerous galleries and popular restaurants that possess regional draws (*Exhibit 4C*).
- *Shortage of State-of-the-Art Apartments* – Santa Ana is under-supplied with Class A rental apartment product, evidenced by high rates of occupancies and rapid rent growth over the past five years (*Exhibit 7*).

The project's marketing challenges are as follows:

- *Distressed Retail Environment* – the rise of e-commerce has had a significant negative impact on “brick- and-mortar” retailers, leading to store closures across the retail landscape. The negative effects of e-commerce have been especially apparent during the current pandemic which has served to accelerate store closings and overall retail contraction (*Appendix C*).

### Apartment Market Performance

- TCG surveyed eight comparable rental projects in the CMA, representing best-in-class product in the cities of Santa Ana, Costa Mesa, Irvine, Tustin, Orange and Anaheim (*Exhibit 8A*).
- The average base rent (ie. an average of the lowest listed rent for each floorplan, excluding premiums for views, orientation and elevation) of the eight comparables surveyed is \$2,606, or \$2.88 per square foot (“PSF”) – top of market rents include Skyloft (average base rent of \$3,024, \$3.32 PSF) and Eleven 10 (\$2,571, \$3.12).

## THE CONCORD GROUP

- The overall rental apartment market is performing strongly, evidenced by:
  - Surveyed occupancy of 94% in stabilized projects (ie. not in lease-up), slightly below 95% stabilization, but high relative the Covid-19 market environment (*Exhibit 8A*).
  - Elevated rent growth – rents in Santa Ana have increased an average of 4.0% per year since 2014 (*Exhibit 7B*).

### Commercial Market Performance

- Neither 4th Street nor Cabrillo Park Drive are established retail corridors in the project's neighborhood around I-5 (*Exhibit 4D*).
- The local 3-mile radius trade area is in general equilibrium, with 44 SF of retail per capital, a ratio on par with the County average (also 44, per *Exhibit 6*).
- There has been limited demand for new retail in the site's 3-mile radius trade area. While the trade area has added only 100,000 SF of new retail 10-years (current inventory of 12.2M SF), occupancy has not changed during the timeframe (*Exhibit 9*).
- The mixed-use character of the multi-family driven projects is limiting to the overall scale of retail opportunity. Successful, large-scale commercial retail projects require anchor tenancy (grocery, department store, etc), a characteristic that cannot be met within the mixed-us context of the site.
  - Two of the three analog mixed-use multi-family / commercial projects surveyed suffer from poor occupancy, each below 50% (*Exhibit 11*).
  - The two low occupancy analogs share both a similar walk score as the subject (60-69 range) and overall scale (13,000 SF average) (*Exhibit 11*).
- Without a critical mass of retail near the site, the project will be challenged to attract a significant scale of retail tenancy.
- The 15,200 SF of commercial retail planned is at the upper end of the range supportable on site
  - Target tenant types will require smaller unit footprints, ranging from 500 to 2,500 SF.
  - Target tenant types include hairdressers, dry cleaners, craft food store, small professional service businesses, etc.



## THE CONCORD GROUP

## Apartment Rent Recommendations

Floorplan	Arnel Program						TCG Recommended Rents					
	Unit Mix		Beds	Den/ Loft	Bath	Unit Size	Base Rent		Avg. Premium		Average Rent	
	Num.	Perc.					\$	\$/sf	\$	%	\$	\$/sf
S1	19	3%	0	---	1	518	\$2,080	\$4.02	\$62	3.0%	\$2,142	\$4.14
S2	20	3%	0	---	1	543	\$2,120	\$3.90	\$64	3.0%	\$2,184	\$4.02
1B - 1	122	19%	1	---	1	683	\$2,425	\$3.55	\$73	3.0%	\$2,498	\$3.66
1B - 2	176	27%	1	---	1	726	\$2,485	\$3.42	\$75	3.0%	\$2,560	\$3.53
1B - 3	3	0%	1	---	1	728	\$2,590	\$3.56	\$78	3.0%	\$2,668	\$3.66
1B - 5	5	1%	1	---	1	750	\$2,545	\$3.39	\$76	3.0%	\$2,621	\$3.50
1B - 4	20	3%	1	---	1	752	\$2,550	\$3.39	\$77	3.0%	\$2,627	\$3.49
2B - 1	140	22%	2	---	2	1,066	\$3,061	\$2.87	\$92	3.0%	\$3,153	\$2.96
2B - 3	68	11%	2	---	2	1,071	\$3,069	\$2.87	\$92	3.0%	\$3,162	\$2.95
2B - 2	40	6%	2	---	2	1,148	\$3,195	\$2.78	\$96	3.0%	\$3,291	\$2.87
3B - 1	25	4%	3	---	3	1,274	\$3,400	\$2.67	\$102	3.0%	\$3,502	\$2.75
3B - 2	6	1%	3	---	3	1,339	\$3,680	\$2.75	\$110	3.0%	\$3,790	\$2.83
<b>Total</b>	<b>644</b>	<b>100%</b>				<b>560,650</b>	<b>\$1,758,803</b>				<b>\$1,811,567</b>	
<b>Average</b>						<b>871</b>	<b>\$2,731</b>	<b>\$3.14</b>	<b>\$82</b>		<b>\$2,813</b>	<b>\$3.23</b>
Studio	39	6%				531	\$2,101	\$3.96	\$63		\$2,164	\$4.08
1-Bed	326	51%				712	\$2,468	\$3.47	\$74		\$2,542	\$3.57
2-Bed	248	39%				1,081	\$3,085	\$2.85	\$93		\$3,178	\$2.94
3-Bed	31	5%				1,287	\$3,454	\$2.68	\$104		\$3,558	\$2.77

- TCG recommends an average base rent of \$2,731, or \$3.14 PSF, placing the project at the near the top of the CMA (*Exhibit 2B*).
- Rent premium garners for elevation, courtyard and views generate an additional \$82 in premium revenue for an average project rent of \$2,813 (\$3.23 PSF).

## Commercial Rent Recommendations

- In-line commercial tenancy will achieve rents ranging from \$28 to \$32 PSF per year (NNN), in line with mixed-use analogs (Appendix B) and at the top of the local 4<sup>th</sup> Street / Irvine Boulevard commercial corridor.

## Market Conclusions

- The current development plan represents the highest and best use for the project.
- Multi-family residential possesses the greatest level of marketability of the MEMU permitted land uses. A regional under-supply of Class A residences is evidenced by high rates of occupancy and rent growth within the product type (*Exhibit 7B*). The project location, just off I-5 and proximate to Downtown Santa Ana, will be highly desirable to prospective residents seeking convenient access to both jobs and entertainment.
- The modest scale of commercial land uses planned is appropriate for the mixed-use orientation of the project. The scale of commercial (15,200) is in alignment with similar scope, multi-family anchored projects elsewhere in Orange County (*Exhibit 11*).

## Fiscal Impact Findings (RSG)

- The multi-family / commercial mixed-use development at the site will provide significantly more fee and tax revenue to the City of Santa Ana as compared to the existing office land use:
  - Approximately \$41.3 million (\$23.1 million in net present value [2020 dollars], discounted at four percent) in additional City General Fund Revenue, including construction period revenues, recurring site-specific tax and other project revenues
  - Approximately \$541,400 in property tax revenue per year, as opposed to the current \$11,700. The site development would generate approximately \$10.3 million after 25 years (discounted)
  - Over the same 25-year period, the City General Fund expenditures associated with the project total \$7.0 million (discounted)
  - As a result, the net new General Fund revenue is projected to be approximately \$28.1 million (\$16.1 million in 2020 dollars) from the acquisition and development of the project
- The Development will generate more revenue to the City in one year than the existing use is projected to generate over the next 25 years

## THE CONCORD GROUP

## Net New Recurring General Fund Fiscal Impacts

Revenue Category	25-Year Recurring	
	Nominal	NPV 4.0%
Property Tax	\$ 18,505,380	\$ 10,333,353
Property Tax In-Lieu	12,096,754	6,756,731
Utility User Tax	3,537,877	1,884,715
Sales Tax	3,479,170	1,853,440
Measure X (2018) Sales Tax Increase	2,753,009	1,786,920
Business Tax	927,121	493,901
<b>Total Revenues</b>	<b>\$ 41,299,312</b>	<b>\$ 23,109,059</b>
Less City Expenditures	\$(13,214,039)	\$(7,026,724)
<b>NET NEW REVENUE TOTAL</b>	<b>\$ 28,085,273</b>	<b>\$ 16,082,335</b>

Sources: City of Santa Ana, County of Orange, California State Board of Equalization, ESRI Business Analyst Online, and RSG, Inc.

The entire fiscal impact study, in detail, is available for review in Section II of this report.

\* \* \* \*

This assignment was completed by Michael Reynolds in association with RSG. We have enjoyed working with you on this assignment and look forward to our continued involvement.

# MARKET ANALYSIS

**EXHIBIT 1**  
**RECOMMENDATIONS**  
**SANTA ANA - CENTRAL POINTE**  
**MAY 2020**

**Project Summary**

- Location:**
- Central Orange County, in the City of Santa Ana
    - Santa Ana is the County seat, with county, state and federal offices all located in Downtown
    - Eastern edge of the city, just east of I-5, at the northwest corner of 4th Street and Cabrillo Park Drive
  - I-5, the West Coast's primary north/south connector, directly fronts the site, connecting renters to major job centers throughout Orange and LA Counties
    - Santa Ana Metrolink Station is just under a mile northeast of the property, linking the site to Southern California's growing rail hub
  - Downtown Santa Ana, a major regional food and entertainment destination, is just over a mile west of the project
- Description:**
- 644 apartment units and 15,200 of street level retail in two 5 story, wrap style buildings
    - 7 stories of parking (with semi-sub); some street front surface parking for retail
    - 8.35-acre site - 80.9 dwelling units per acre
  - Extensive community amenity program include two roof top courtyards with pools and large community park central to the project
  - Interior unit specifications on par with best-in-class, Orange County Class "A" rental market

**Marketability Metrics**

- Market Strengths:**
- *Regional Accessibility*
    - I-5 and the Santa Ana Metrolink Station are both proximate to the site
  - *Proximity to White Collar Jobs*
    - In addition to downtown Santa Ana, multiple major Orange County employment cores are located within a five-mile radius, including South Coast Metro, Irvine Business Complex and Anaheim/Orange
  - *Arts and Dining Destination*
    - Project is located proximate to the city's Artists Village, home to numerous galleries and popular restaurants that possess regional draws
  - *Lack of Class A Institutional Supply*
    - The city is under-supplied with luxury, "Class A" apartment product
    - Santa Ana's gentrification to date has focused primarily on retail and office redevelopment
    - Indicative of the City's housing shortage, the City boasts a jobs to housing ratio of 1.2, higher than the County average of 1.1
- Market Challenges:**
- *Distressed Retail Environment*
    - The rise of e-commerce has had a significant negative impact on "brick- and-mortar" retailers, leading to store closures across the retail landscape. The negative effects of e-commerce have been especially apparent during the current pandemic which has served to accelerate store closings

**Multi-Family Program & Recommended Rents**

- Positioning Thesis:**
- Subject site base rents are positioned slightly below the top of upscale, low-rise competitive set in Central Orange County
    - Top-of-market positioning is merited by the project's downtown Santa Ana location, Orange County's only authentic, walkable Downtown neighborhood, accessibility to the 5 freeway, planned high level of amenities, and interior unit specifications
    - Average base rent of \$3.14 PSF positions the project generally in line with Eleven 10 (\$3.12), a project with a superior location in the Platinum Triangle in Orange

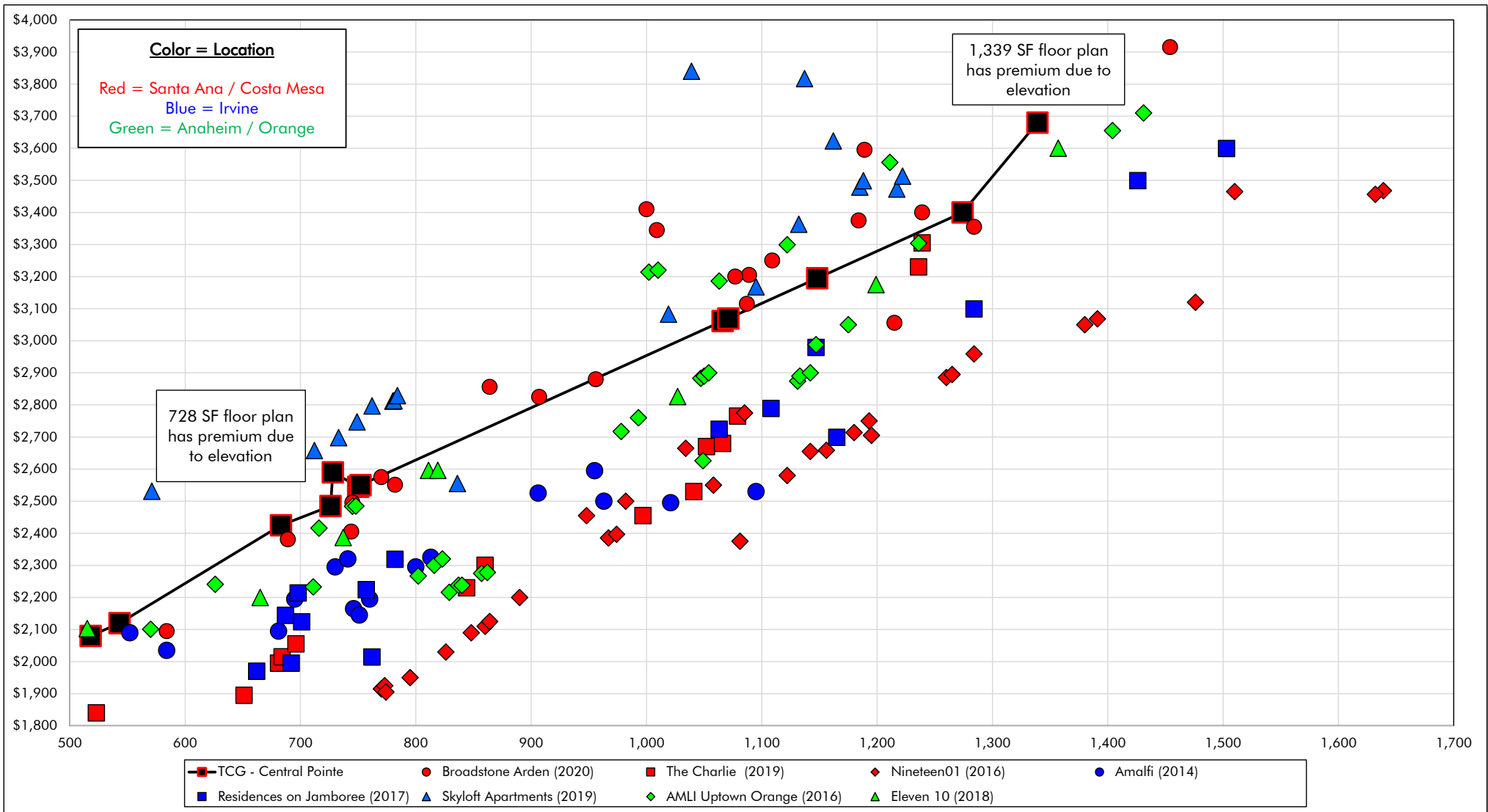
MF Program:	Arnel Program						TCG Recommended Rents						
	Floorplan	Unit Mix		Beds	Den/Loft	Bath	Unit Size	Base Rent		Avg. Premium		Average Rent	
		Num.	Perc.					\$	\$/sf	\$	%	\$	\$/sf
S1	19	3%	0	---	1	518	\$2,080	\$4.02	\$62	3.0%	\$2,142	\$4.14	
S2	20	3%	0	---	1	543	\$2,120	\$3.90	\$64	3.0%	\$2,184	\$4.02	
1B - 1	122	19%	1	---	1	683	\$2,425	\$3.55	\$73	3.0%	\$2,498	\$3.66	
1B - 2	176	27%	1	---	1	726	\$2,485	\$3.42	\$75	3.0%	\$2,560	\$3.53	
1B - 3	3	0%	1	---	1	728	\$2,590	\$3.56	\$78	3.0%	\$2,668	\$3.66	
1B - 5	5	1%	1	---	1	750	\$2,545	\$3.39	\$76	3.0%	\$2,621	\$3.50	
1B - 4	20	3%	1	---	1	752	\$2,550	\$3.39	\$77	3.0%	\$2,627	\$3.49	
2B - 1	140	22%	2	---	2	1,066	\$3,061	\$2.87	\$92	3.0%	\$3,153	\$2.96	
2B - 3	68	11%	2	---	2	1,071	\$3,069	\$2.87	\$92	3.0%	\$3,162	\$2.95	
2B - 2	40	6%	2	---	2	1,148	\$3,195	\$2.78	\$96	3.0%	\$3,291	\$2.87	
3B - 1	25	4%	3	---	3	1,274	\$3,400	\$2.67	\$102	3.0%	\$3,502	\$2.75	
3B - 2	6	1%	3	---	3	1,339	\$3,680	\$2.75	\$110	3.0%	\$3,790	\$2.83	
<b>Total</b>	<b>644</b>	<b>100%</b>				<b>560,650</b>	<b>\$1,758,803</b>				<b>\$1,811,567</b>		
<b>Average</b>						<b>871</b>	<b>\$2,731</b>	<b>\$3.14</b>	<b>\$82</b>		<b>\$2,813</b>	<b>\$3.23</b>	

**Commercial Program and Recommended Rents**

- Commercial Program:**
- TCG recommends an average rent of \$30 PSF per year (NNN) for the 15,200 SF of retail
  - Rent recommendations are in line with mixed-use analogs in Orange County - namely Pinnacle at MacArthur Place (local to Santa Ana) and Pinnacle at Fullerton (downtown Fullerton address)
  - Recommended rents are positioned at the top of the 4th Street / Irvine Boulevard corridor
  - TCG projects a slow to moderate paced lease-up, based primarily on the relative low rate of occupancy at the Pinnacle at MacArthur Place project

EXHIBIT 2A

MF RENT POSITIONING - RENT TO SIZE GRAPH  
 SANTA ANA, COSTA MESA, ORANGE AND TUSTIN  
 MAY 2020



Source: Appendix A

EXHIBIT 2B

MF RENT POSITIONING - ABSOLUTE RENT  
SANTA ANA, COSTA MESA, ORANGE AND TUSTIN  
MAY 2020

Rents listed are "base" - an average of the lowest listed rents per floorplan

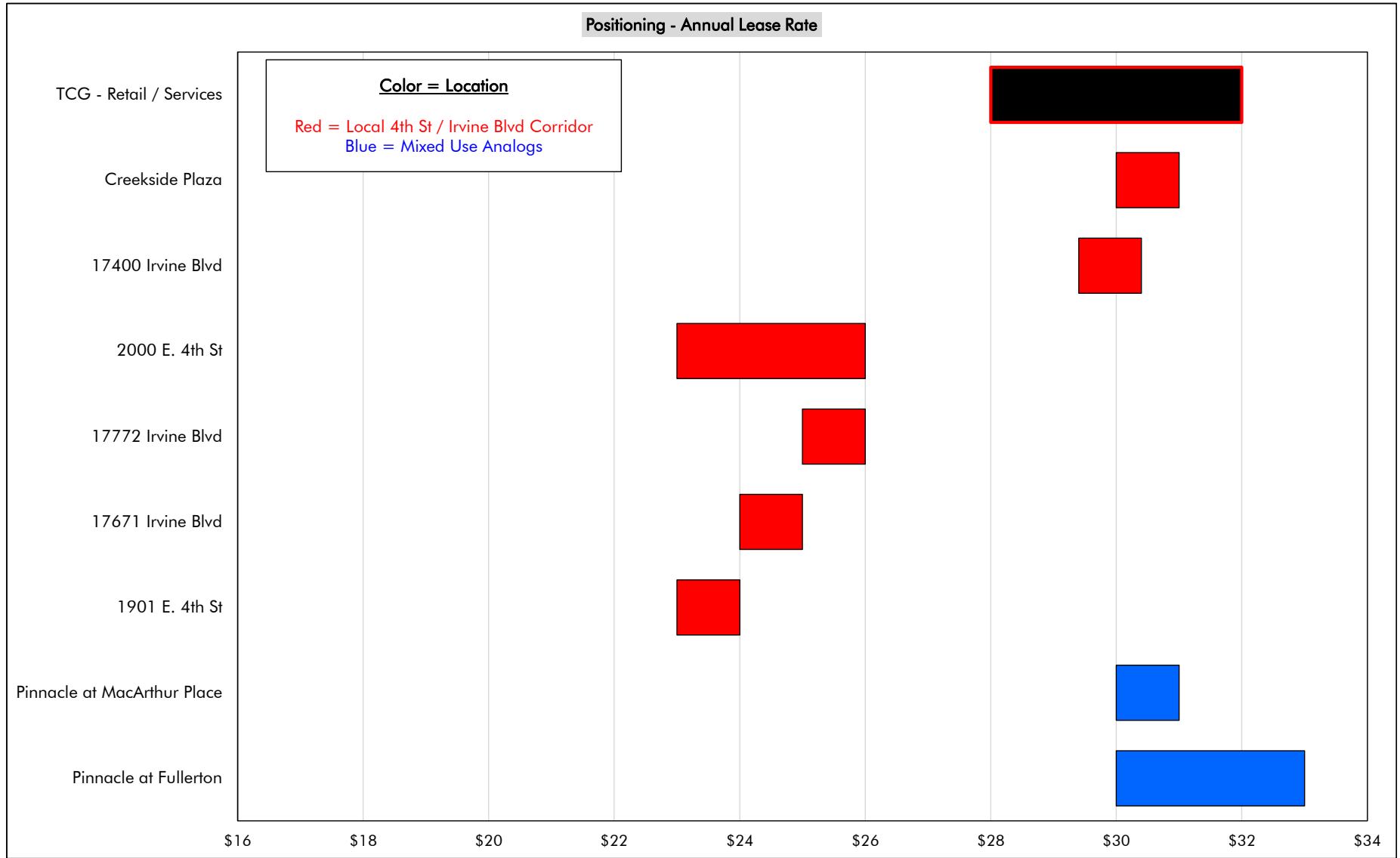
**Color = Location**  
Red = Santa Ana / Costa Mesa  
Blue = Irvine / Tustin  
Green = Anaheim / Orange

Map Key	Project Name	Units	Year Built	Occ.	Unit Mix (by Bed Count)			Overall			Project Averages (Size and List Rent)								
					0	1	2	Unit Size	Base Rent		Studios			One-Bedrooms			Two-Bedrooms		
									\$	\$/sf	Unit Size	\$	\$/sf	Unit Size	\$	\$/sf	Unit Size	\$	\$/sf
<b>1-Bed Sort</b>																			
<b>A</b>	Broadstone Arden	335	2020	26%	26%	19%	53%	1,023	\$3,063	\$2.99	800	\$2,676	\$3.34	881	\$2,769	\$3.14	1,157	\$3,312	\$2.86
<b>F</b>	Skyloft Apartments	388	2019	19%	8%	54%	36%	910	\$3,024	\$3.32	571	\$2,531	\$4.43	768	\$2,713	\$3.53	1,165	\$3,513	\$3.02
<b>TCG - Central Pointe</b>								<b>871</b>	<b>\$2,731</b>	<b>\$3.14</b>	<b>531</b>	<b>\$2,101</b>	<b>\$3.96</b>	<b>712</b>	<b>\$2,468</b>	<b>\$3.47</b>	<b>1,081</b>	<b>\$3,085</b>	<b>\$2.85</b>
<b>H</b>	Eleven 10	260	2018	93%	21%	51%	28%	825	\$2,571	\$3.12	515	\$2,103	\$4.08	764	\$2,463	\$3.22	1,167	\$3,118	\$2.67
<b>G</b>	AMLl Uptown Orange	334	2016	93%	3%	45%	51%	930	\$2,663	\$2.86	570	\$2,101	\$3.69	782	\$2,307	\$2.95	1,071	\$2,986	\$2.79
<b>D</b>	Amalfi	542	2014	95%	12%	69%	19%	785	\$2,268	\$2.89	584	\$2,035	\$3.48	748	\$2,242	\$3.00	1,046	\$2,510	\$2.40
<b>E</b>	Residences on Jamboree	381	2017	96%	18%	43%	33%	897	\$2,447	\$2.73	690	\$1,994	\$2.89	724	\$2,132	\$2.95	1,134	\$2,906	\$2.56
<b>B</b>	The Charlie	228	2019	13%	10%	40%	42%	875	\$2,373	\$2.71	542	\$1,848	\$3.41	708	\$2,060	\$2.91	1,048	\$2,633	\$2.51
<b>C</b>	Nineteen01	261	2016	90%	0%	46%	50%	1,072	\$2,495	\$2.33	---	---	---	831	\$2,056	\$2.47	1,235	\$2,804	\$2.27
<b>Total/Average:</b>		<b>2,729</b>	<b>2017</b>	<b>68%</b>	<b>12%</b>	<b>48%</b>	<b>37%</b>	<b>904</b>	<b>\$2,606</b>	<b>\$2.88</b>	<b>645</b>	<b>\$2,236</b>	<b>\$3.47</b>	<b>765</b>	<b>\$2,329</b>	<b>\$3.04</b>	<b>1,130</b>	<b>\$3,010</b>	<b>\$2.66</b>
Excluding Lease-Ups:		1,778		94%															
<b>2-Bed Sort</b>																			
<b>F</b>	Skyloft Apartments	388	2019	19%	8%	54%	36%	910	\$3,024	\$3.32	571	\$2,531	\$4.43	768	\$2,713	\$3.53	1,165	\$3,513	\$3.02
<b>A</b>	Broadstone Arden	335	2020	26%	26%	19%	53%	1,023	\$3,063	\$2.99	800	\$2,676	\$3.34	881	\$2,769	\$3.14	1,157	\$3,312	\$2.86
<b>H</b>	Eleven 10	260	2018	93%	21%	51%	28%	825	\$2,571	\$3.12	515	\$2,103	\$4.08	764	\$2,463	\$3.22	1,167	\$3,118	\$2.67
<b>TCG - Central Pointe</b>								<b>871</b>	<b>\$2,731</b>	<b>\$3.14</b>	<b>531</b>	<b>\$2,101</b>	<b>\$3.96</b>	<b>712</b>	<b>\$2,468</b>	<b>\$3.47</b>	<b>1,081</b>	<b>\$3,085</b>	<b>\$2.85</b>
<b>G</b>	AMLl Uptown Orange	334	2016	93%	3%	45%	51%	930	\$2,663	\$2.86	570	\$2,101	\$3.69	782	\$2,307	\$2.95	1,071	\$2,986	\$2.79
<b>E</b>	Residences on Jamboree	381	2017	96%	18%	43%	33%	897	\$2,447	\$2.73	690	\$1,994	\$2.89	724	\$2,132	\$2.95	1,134	\$2,906	\$2.56
<b>C</b>	Nineteen01	261	2016	90%	0%	46%	50%	1,072	\$2,495	\$2.33	---	---	---	831	\$2,056	\$2.47	1,235	\$2,804	\$2.27
<b>B</b>	The Charlie	228	2019	13%	10%	40%	42%	875	\$2,373	\$2.71	542	\$1,848	\$3.41	708	\$2,060	\$2.91	1,048	\$2,633	\$2.51
<b>D</b>	Amalfi	542	2014	95%	12%	69%	19%	785	\$2,268	\$2.89	584	\$2,035	\$3.48	748	\$2,242	\$3.00	1,046	\$2,510	\$2.40
<b>Studio Sort</b>																			
<b>A</b>	Broadstone Arden	335	2020	26%	26%	19%	53%	1,023	\$3,063	\$2.99	800	\$2,676	\$3.34	881	\$2,769	\$3.14	1,157	\$3,312	\$2.86
<b>F</b>	Skyloft Apartments	388	2019	19%	8%	54%	36%	910	\$3,024	\$3.32	571	\$2,531	\$4.43	768	\$2,713	\$3.53	1,165	\$3,513	\$3.02
<b>H</b>	Eleven 10	260	2018	93%	21%	51%	28%	825	\$2,571	\$3.12	515	\$2,103	\$4.08	764	\$2,463	\$3.22	1,167	\$3,118	\$2.67
<b>TCG - Central Pointe</b>								<b>871</b>	<b>\$2,731</b>	<b>\$3.14</b>	<b>531</b>	<b>\$2,101</b>	<b>\$3.96</b>	<b>712</b>	<b>\$2,468</b>	<b>\$3.47</b>	<b>1,081</b>	<b>\$3,085</b>	<b>\$2.85</b>
<b>G</b>	AMLl Uptown Orange	334	2016	93%	3%	45%	51%	930	\$2,663	\$2.86	570	\$2,101	\$3.69	782	\$2,307	\$2.95	1,071	\$2,986	\$2.79
<b>D</b>	Amalfi	542	2014	95%	12%	69%	19%	785	\$2,268	\$2.89	584	\$2,035	\$3.48	748	\$2,242	\$3.00	1,046	\$2,510	\$2.40
<b>E</b>	Residences on Jamboree	381	2017	96%	18%	43%	33%	897	\$2,447	\$2.73	690	\$1,994	\$2.89	724	\$2,132	\$2.95	1,134	\$2,906	\$2.56
<b>B</b>	The Charlie	228	2019	13%	10%	40%	42%	875	\$2,373	\$2.71	542	\$1,848	\$3.41	708	\$2,060	\$2.91	1,048	\$2,633	\$2.51

Source: Appendix A

EXHIBIT 3

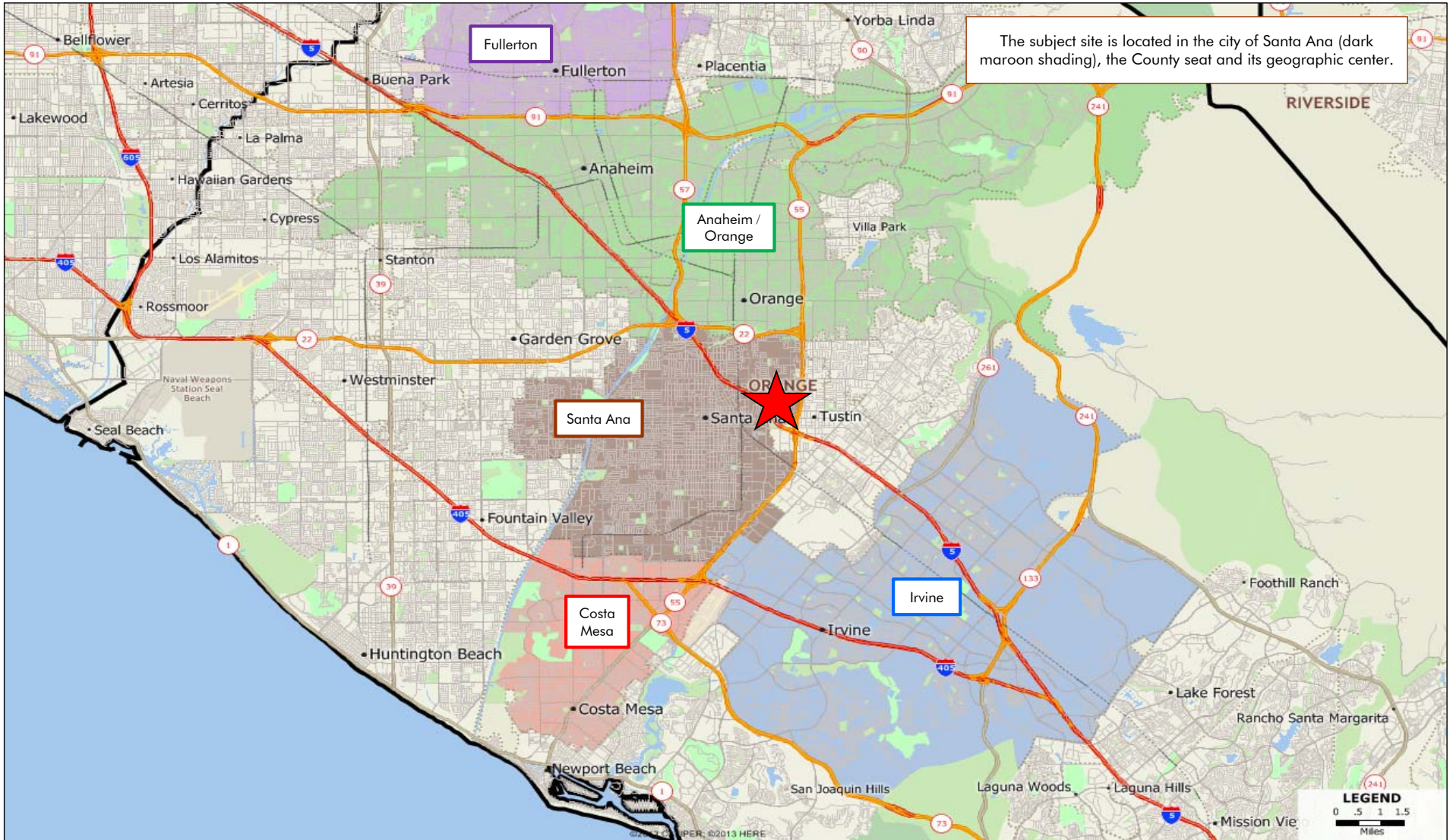
RETAIL / OFFICE RENT POSITIONING  
ORANGE COUNTY AND LOCAL THREE-MILE TRADE AREA  
JANUARY 2017 THROUGH JULY 2020 - 3.5-YEARS



Source: Appendix B

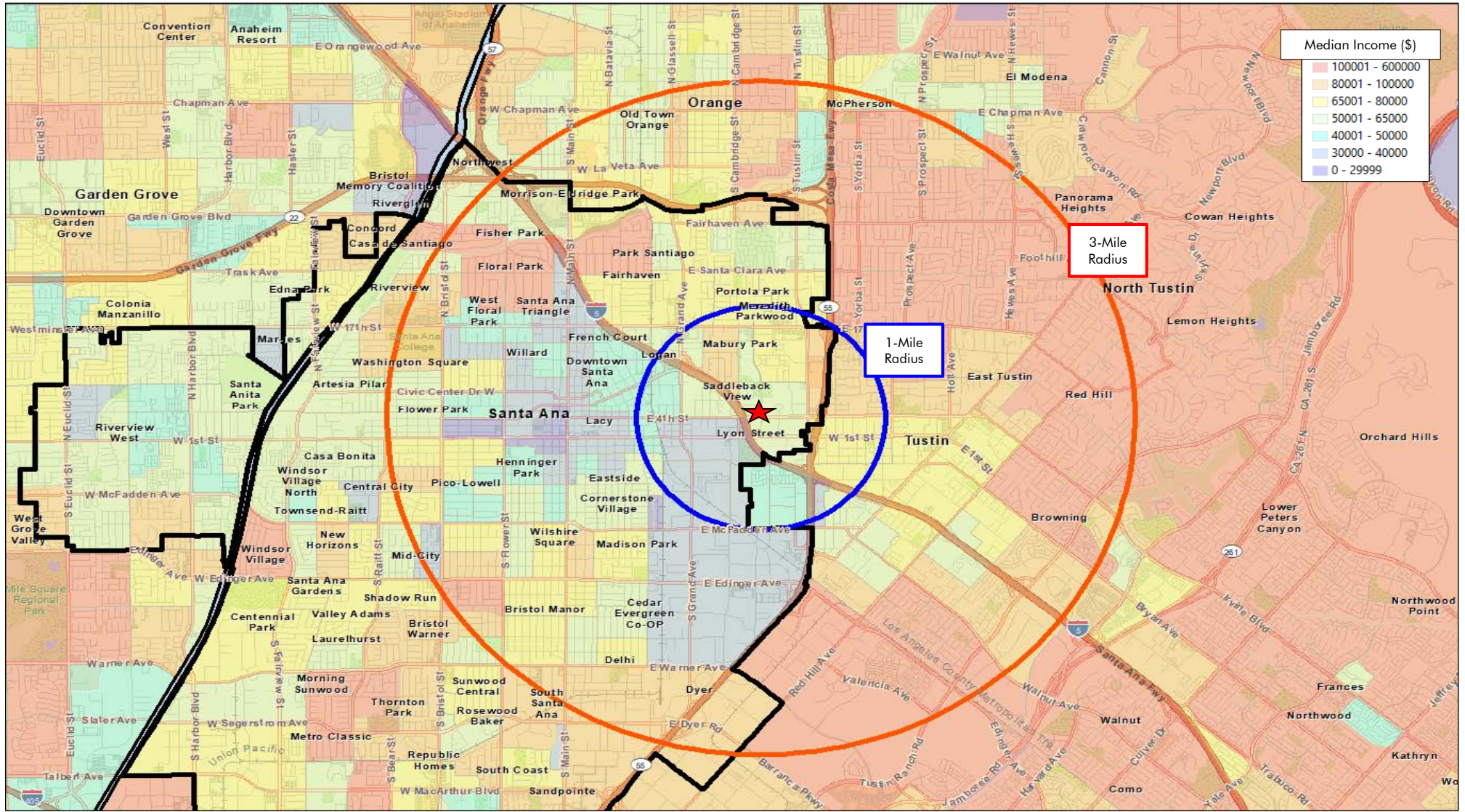


EXHIBIT 4A  
PROJECT LOCATION - REGIONAL  
ORANGE COUNTY  
MAY 2020



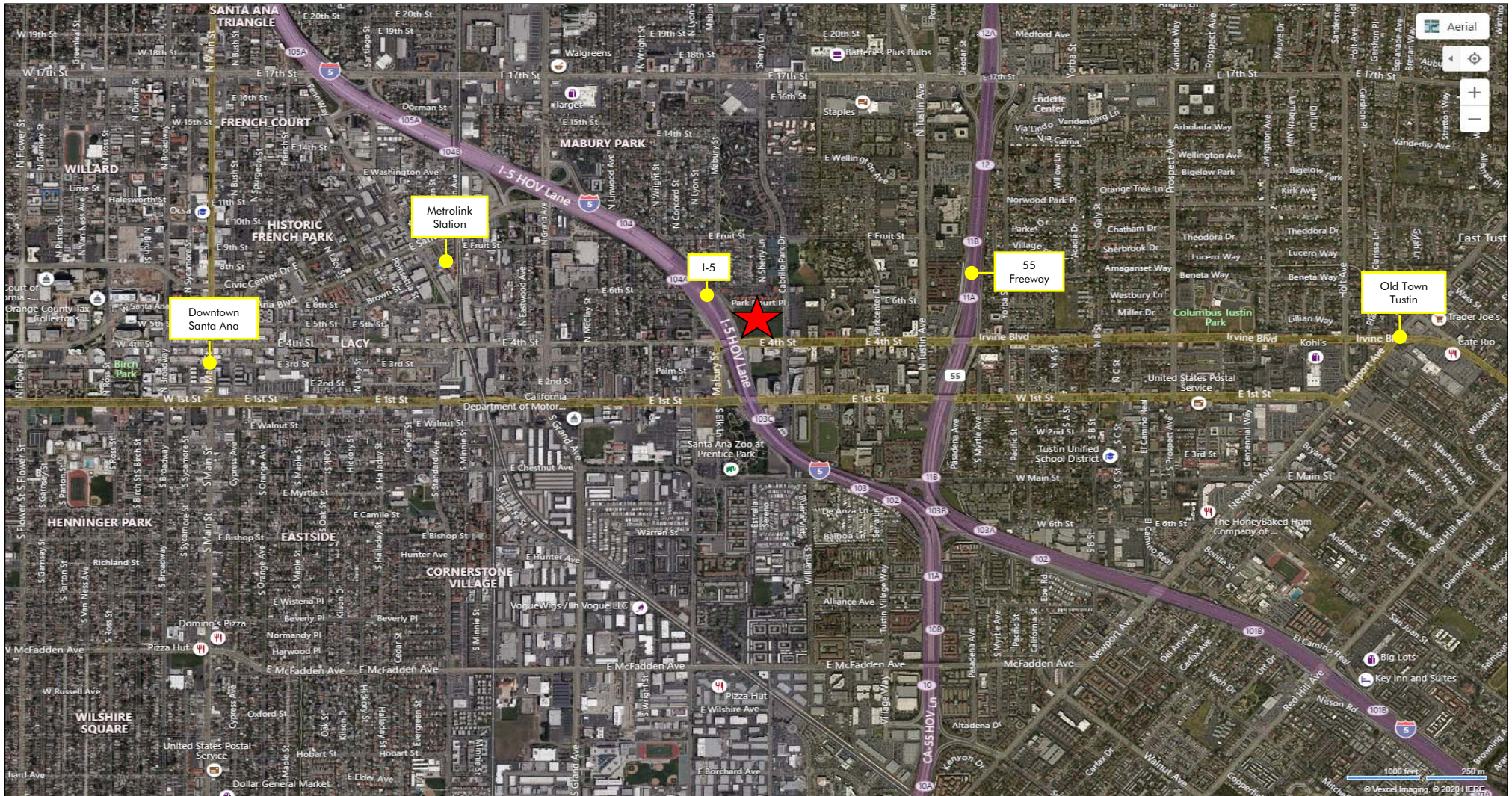
Map: Mapitude

EXHIBIT 4B  
PROJECT LOCATION - MEDIAN INCOME  
ORANGE COUNTY  
MAY 2020



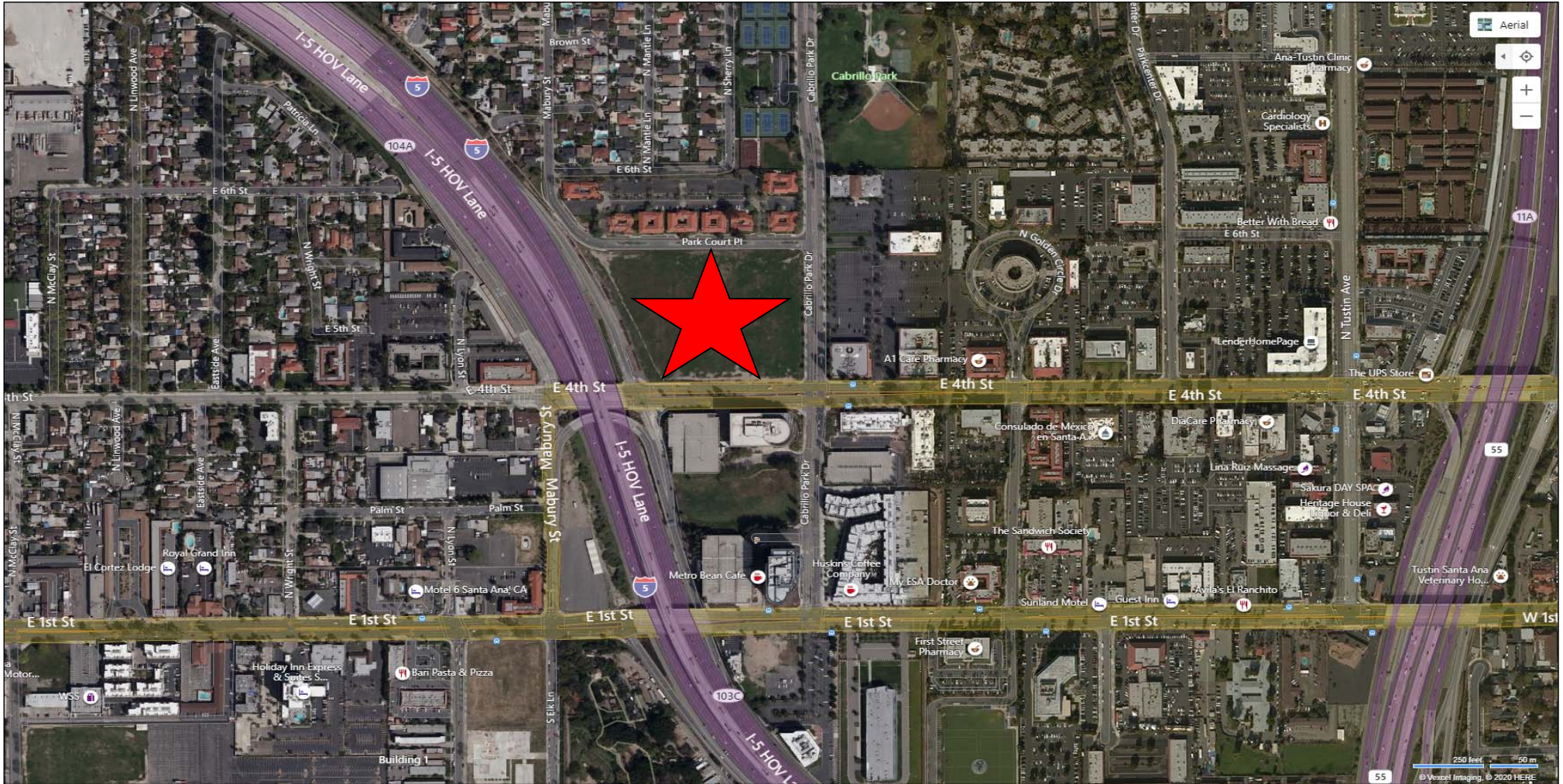
Source: ESRI

EXHIBIT 4C  
PROJECTION LOCATION - LOCAL SETTING  
SANTA ANA / TUSTIN  
MAY 2020



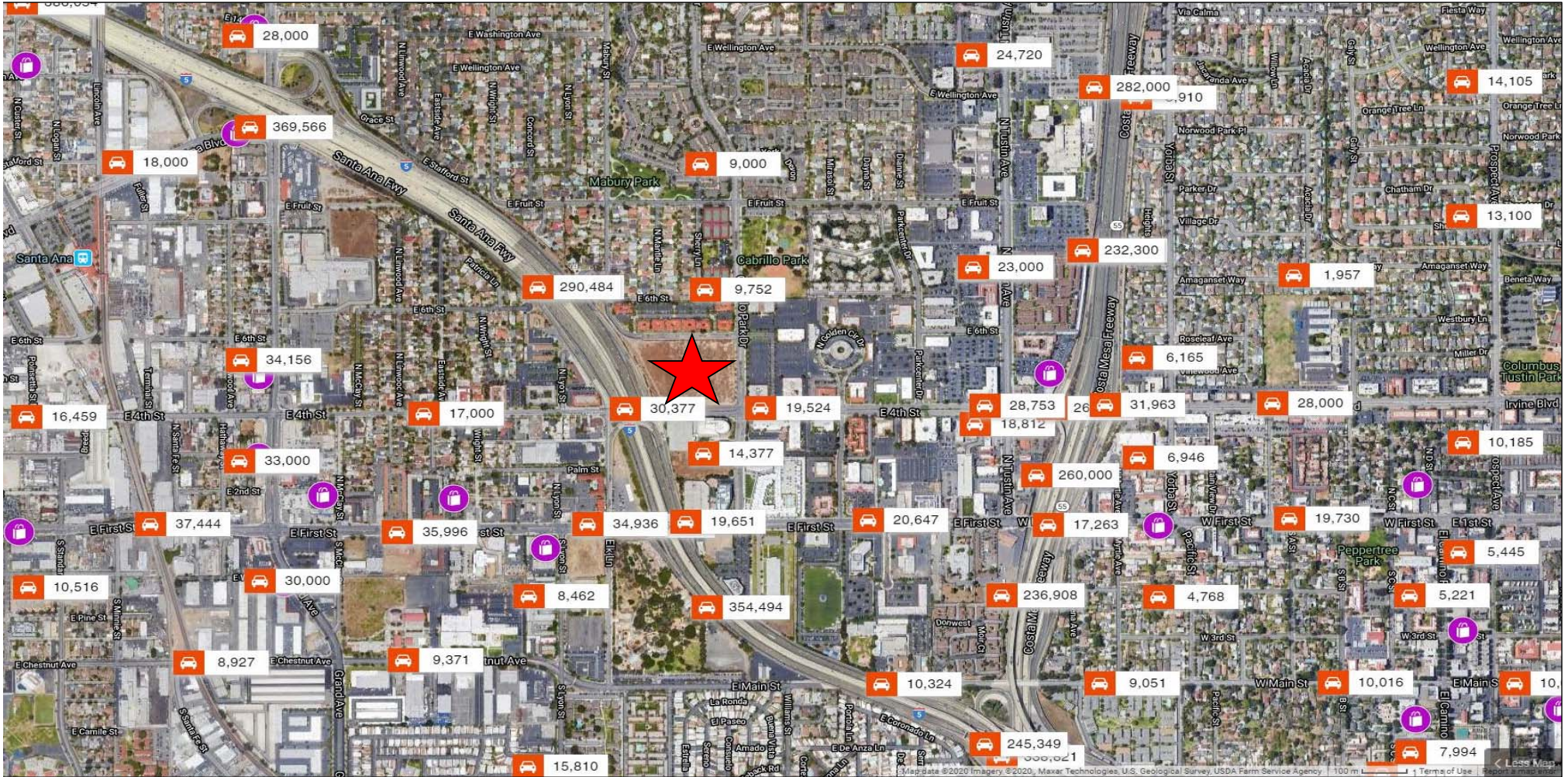
Map: BingMaps

EXHIBIT 4D  
PROJECTION LOCATION - SURROUNDING LAND USES  
SANTA ANA  
MAY 2020



Map: BingMaps

EXHIBIT 4E  
PROJECTION LOCATION - TRAFFIC COUNTS  
SANTA ANA  
MAY 2020



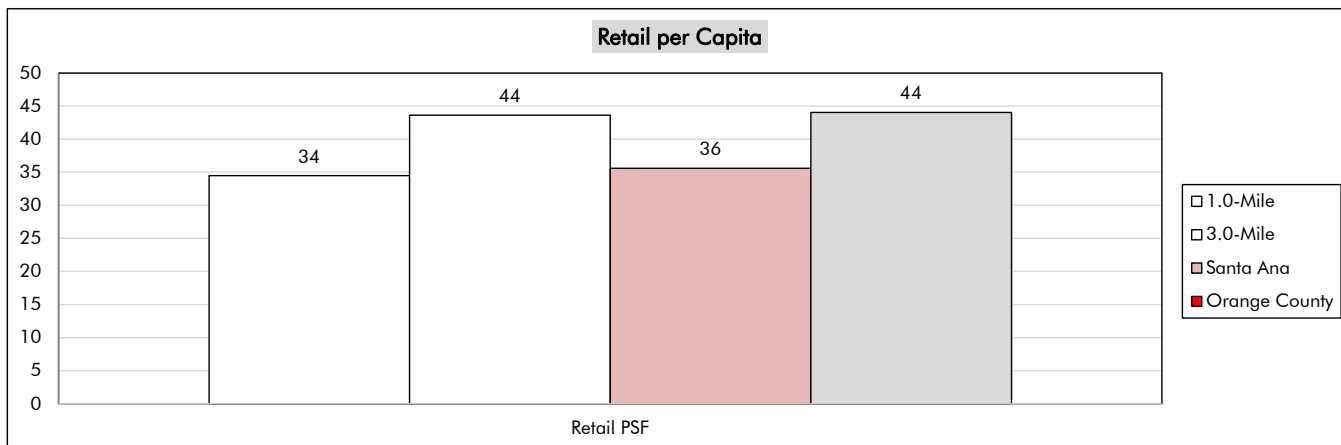
Map: CoStar

EXHIBIT 5  
SITE PLAN  
4TH AND CABRILLO - SANTA ANA  
MAY 2020



**EXHIBIT 6  
DEMOGRAPHICS  
ORANGE COUNTY  
2019**

Geography:	Local Radii								U.S.	
	1.0-Mile		3.0-Mile		Santa Ana		Orange County		Num.	Perc.
	Num.	Perc.	Num.	Perc.	Num.	Perc.	Num.	Perc.		
<b>Population</b>										
2019	34,761		280,411		340,347		3,252,459		332,417,793	
2024	35,921		287,653		349,390		3,368,861		345,487,602	
Gr./ Yr.	232	0.7%	1,448	0.5%	1,809	0.5%	23,280	0.7%	2,613,962	0.8%
<b>Households</b>										
2010	9,395		71,438		73,123		992,781		116,716,292	
2019	9,853		73,769		75,607		1,060,886		125,168,557	
Gr./ Yr.	51	0.5%	259	0.4%	276	0.4%	7,567	0.7%	939,141	0.8%
2024	10,107		75,335		77,346		1,095,455		129,922,162	
Gr./ Yr.	51	0.5%	313	0.4%	348	0.5%	6,914	0.6%	950,721	0.7%
<b>Renters ('19)</b>	6,615	67%	41,031	56%	41,674	55%	458,189	43%	45,709,279	37%
<b>HH Size ('19)</b>	3.5		3.8		4.5		3.1		2.7	
1 Person	2,026	21%	12,535	17%	9,533	13%	222,107	21%	33,464,681	27%
1-2 Persons	4,178	42%	29,106	39%	22,207	29%	532,561	50%	74,476,732	60%
3+ Persons	5,675	58%	44,663	61%	53,400	71%	528,325	50%	50,691,825	40%
Family HHs	7,128	72%	56,102	76%	61,665	82%	757,094	71%	83,153,401	66%
<b>Median Income (000s)</b>										
2019	\$53		\$67		\$60		\$88		\$61	
2024	\$60		\$78		\$71		\$103		\$69	
Gr./ Yr.	\$1.2	2.2%	\$2.3	3.3%	\$2.2	3.5%	\$2.9	3.0%	\$1.7	2.7%
<b>Income Profile ('19)</b>										
Over \$50K	5,396	55%	46,846	64%	45,254	60%	771,621	73%	73,892,464	59%
Over \$75K	3,124	32%	33,370	45%	29,958	40%	614,698	58%	51,974,116	42%
Over \$100K	1,732	18%	23,171	31%	19,230	25%	475,348	45%	36,152,986	29%
Over \$150K	706	7%	11,239	15%	7,697	10%	269,674	25%	17,309,482	14%
Over \$200K	299	3%	5,690	8%	3,201	4%	156,471	15%	9,153,435	7%
<b>Age Profile ('19)</b>										
Median - Pop.	30		32		31		37		39	
Householder										
Under 25	462	5%	2,556	3%	2,435	3%	30,673	3%	5,004,274	4%
25-34	2,032	21%	12,762	17%	13,551	18%	153,712	14%	19,381,040	15%
35-44	2,305	23%	15,575	21%	16,632	22%	190,990	18%	20,976,243	17%
45-54	1,984	20%	15,337	21%	16,677	22%	209,921	20%	22,103,882	18%
55-64	1,493	15%	12,785	17%	12,992	17%	207,275	20%	24,301,863	19%
65 Plus	1,576	16%	14,754	20%	13,321	18%	268,296	25%	33,399,611	27%
<b>Retail Inventory</b>										
SF (000s) (QTD)	1,198		12,231		12,117		143,250			
SF per Person	34		44		36		44			

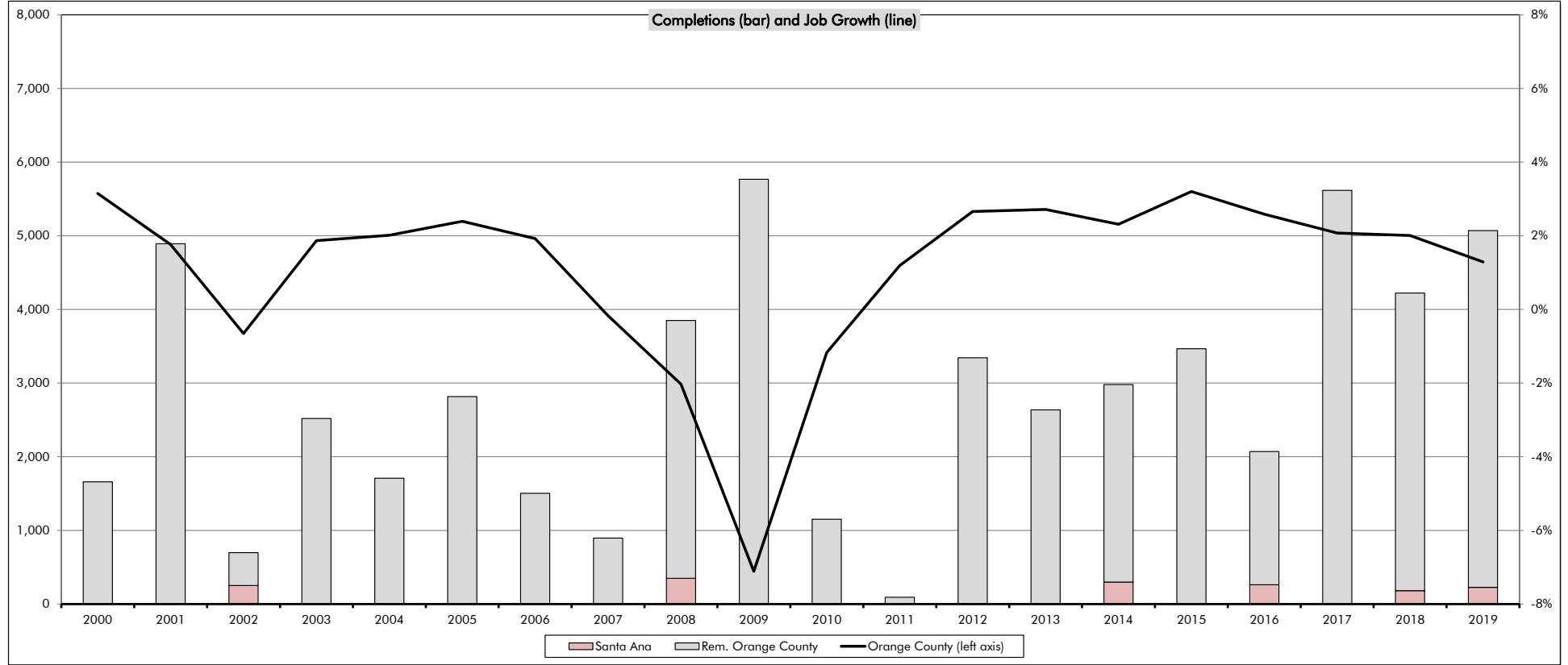


Source: ESRI

EXHIBIT 7A

MF MACRO-MARKET PERFORMANCE - INVENTORY & DELIVERIES  
ORANGE COUNTY  
2000 THROUGH FIRST QUARTER 2020

Values in 000s	Annual																				Annual Average			YTD - Apr-20		
	2000	2001	2002	2003	2004	2005	2006	2007	2008	2009	2010	2011	2012	2013	2014	2015	2016	2017	2018	2019	5-Yr	10-Yr	15-Yr	1Q20	Num.	%Inv
<b>Job Growth</b>																										
Orange County	3.1%	1.8%	-0.7%	1.9%	2.0%	2.4%	1.9%	-0.2%	-2.0%	-7.1%	-1.2%	1.2%	2.7%	2.7%	2.3%	3.2%	2.6%	2.1%	2.0%	1.3%				0.9%		
<b>Inventory (000s)</b>																										
Orange County	204.6	207.7	210.5	212.3	214.1	216.7	218.9	219.4	222.0	225.9	229.6	230.1	232.2	234.6	237.4	240.6	243.4	248.5	252.6	256.1				260.4		
Santa Ana	19.7	19.7	19.9	19.9	19.9	19.9	19.9	19.7	19.8	20.1	20.1	20.1	20.1	20.0	20.3	20.3	20.5	20.6	20.8	20.8				22.2		
% County	9.6%	9.5%	9.5%	9.4%	9.3%	9.2%	9.1%	9.0%	8.9%	8.9%	8.7%	8.7%	8.6%	8.5%	8.6%	8.4%	8.4%	8.3%	8.2%	8.1%				8.5%		
<b>Completions (000s)</b>																										
Orange County	1.66	4.89	0.70	2.52	1.71	2.82	1.51	0.90	3.85	5.77	1.15	0.09	3.34	2.64	2.98	3.47	2.07	5.62	4.22	5.07	4.09	3.28	3.03	1.65	3.22	1.2%
Santa Ana	0.00	0.00	0.25	0.00	0.00	0.00	0.00	0.00	0.35	0.00	0.00	0.00	0.00	0.00	0.30	0.00	0.26	0.00	0.18	0.23	0.13	0.11	0.09	1.22	0.22	1.0%
% County	0%	0%	36%	0%	0%	0%	0%	0%	9%	0%	0%	0%	0%	0%	10%	0%	13%	0%	4%	4%	3%	3%	3%	74%	7%	



Source: Jobs - BLS; Apartment - CoStar (for projects that are 5+ units)

Note: "U/C" - under construction



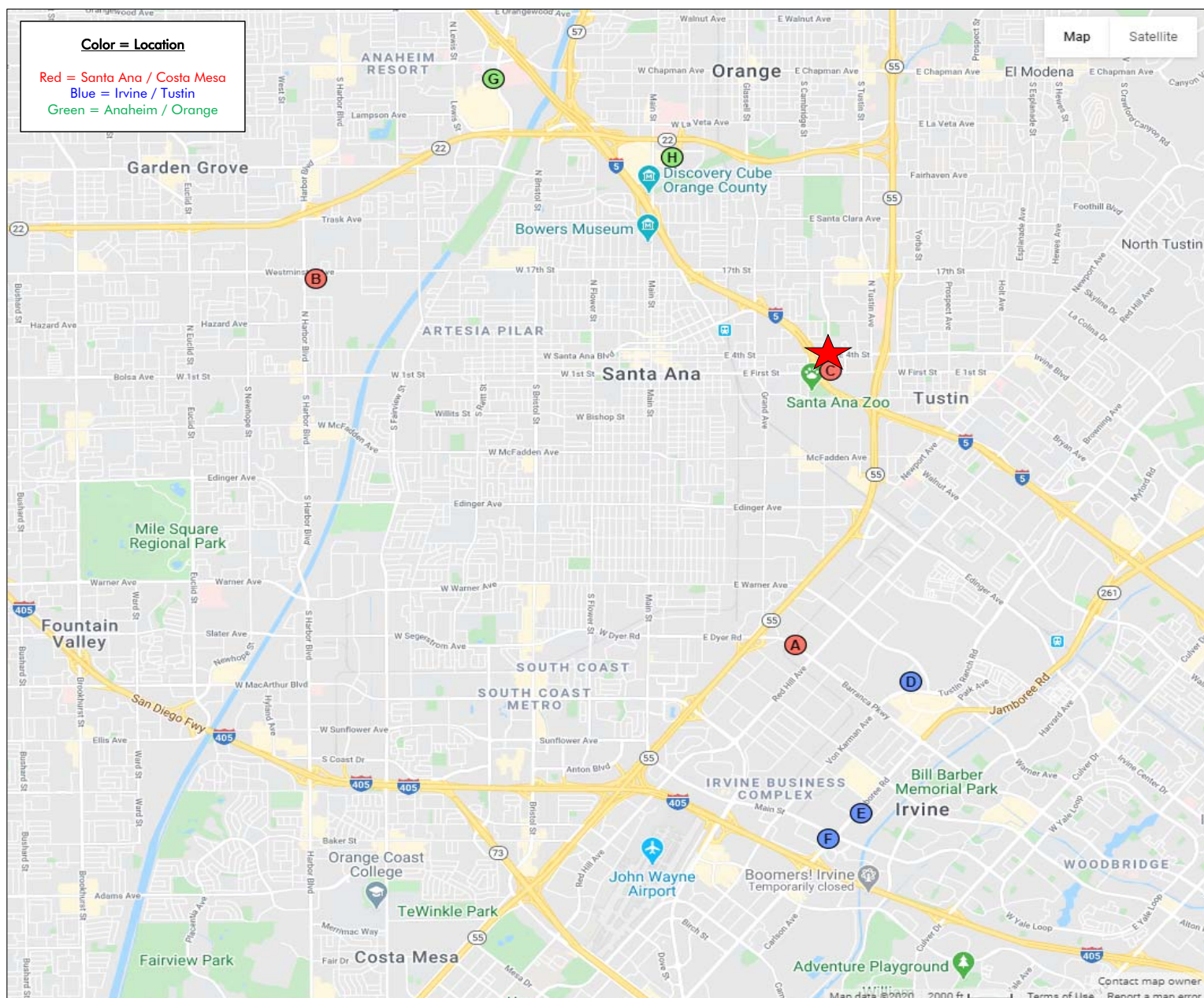


EXHIBIT 8A

MF INVENTORY - LOCATION & PERFORMANCE  
SANTA ANA, COSTA MESA, ORANGE AND TUSTIN  
MAY 2020

Rents listed are "base" - an average of the lowest listed rents per floorplan

Map Key	Project Name	Units	Year Built	Occ.	Unit Mix (by Bed Count)			Overall			Project Averages (Size and List Rent)								
					0	1	2	Unit Size	Base Rent		Studios		One-Bedrooms		Two-Bedrooms				
									\$	\$/sf	Unit Size	Base Rent	\$/sf	Unit Size	Base Rent	\$/sf	Unit Size	Base Rent	\$/sf
F	Skyloft Apartments	388	2019	19%	8%	54%	36%	910	\$3,024	\$3.32	571	\$2,531	\$4.43	768	\$2,713	\$3.53	1,165	\$3,513	\$3.02
H	Eleven 10	260	2018	93%	21%	51%	28%	825	\$2,571	\$3.12	515	\$2,103	\$4.08	764	\$2,463	\$3.22	1,167	\$3,118	\$2.67
A	Broadstone Arden	335	2020	26%	26%	19%	53%	1,023	\$3,063	\$2.99	800	\$2,676	\$3.34	881	\$2,769	\$3.14	1,157	\$3,312	\$2.86
D	Amalfi	542	2014	95%	12%	69%	19%	785	\$2,268	\$2.89	584	\$2,035	\$3.48	748	\$2,242	\$3.00	1,046	\$2,510	\$2.40
E	Residences on Jamboree	381	2017	96%	18%	43%	33%	897	\$2,447	\$2.73	690	\$1,994	\$2.89	724	\$2,132	\$2.95	1,134	\$2,906	\$2.56
G	AMLI Uptown Orange	334	2016	93%	3%	45%	51%	930	\$2,663	\$2.86	570	\$2,101	\$3.69	782	\$2,307	\$2.95	1,071	\$2,986	\$2.79
B	The Charlie	228	2019	13%	10%	40%	42%	875	\$2,373	\$2.71	542	\$1,848	\$3.41	708	\$2,060	\$2.91	1,048	\$2,633	\$2.51
C	Nineteen01	261	2016	90%	0%	46%	50%	1,072	\$2,495	\$2.33	---	---	---	831	\$2,056	\$2.47	1,235	\$2,804	\$2.27
<b>Total/Average:</b>		<b>2,729</b>	<b>2017</b>	<b>68%</b>	<b>12%</b>	<b>48%</b>	<b>37%</b>	<b>904</b>	<b>\$2,606</b>	<b>\$2.88</b>	<b>645</b>	<b>\$2,236</b>	<b>\$3.47</b>	<b>765</b>	<b>\$2,329</b>	<b>\$3.04</b>	<b>1,130</b>	<b>\$3,010</b>	<b>\$2.66</b>
Excluding Lease-Ups:		1,778		94%															



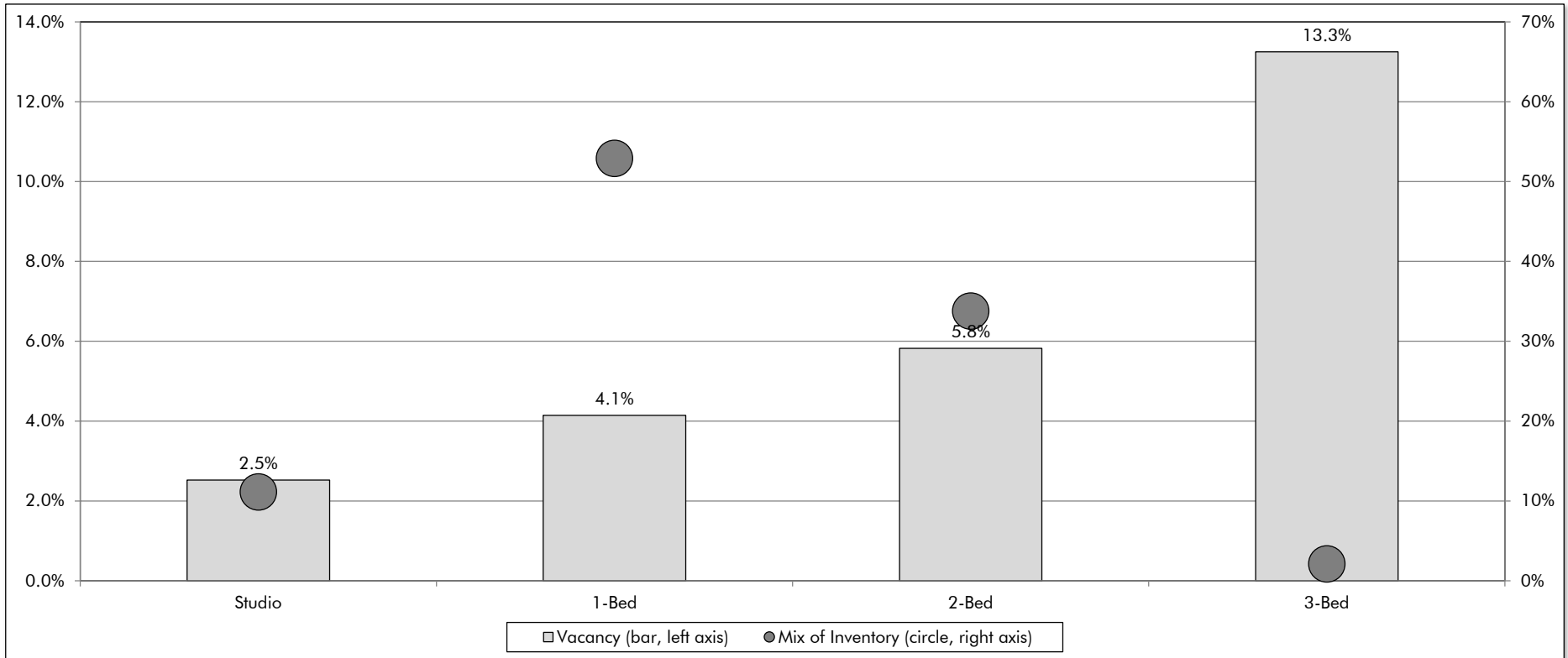
Source: Appendix A

EXHIBIT 8B

MF INVENTORY - VACANCY BY UNIT TYPE  
SANTA ANA, COSTA MESA, ORANGE AND TUSTIN  
MAY 2020

**Color = Location**  
Red = Santa Ana / Costa Mesa  
Blue = Irvine / Tustin  
Green = Anaheim / Orange

Project Name	Year Built	1B \$/SF	Units	Unit Sizes				Unit Count				Unit Mix				Vacancy	Vacancy Rate By Unit Type			
				0	1	2	3	0	1	2	3	0	1	2	3		0	1	2	3
Eleven 10	2018	\$3.22	260	515	764	1,167	---	55	133	73	0	21%	51%	28%	0%	7%	4%	1%	0%	---
Amalfi	2014	\$3.00	542	584	748	1,046	---	65	374	103	0	12%	69%	19%	0%	5%	0%	5%	13%	---
Residences on Jamboree	2017	\$2.95	381	690	724	1,134	1,452	69	164	126	23	18%	43%	33%	6%	4%	3%	2%	4%	13%
AMLI Uptown Orange	2016	\$2.95	334	570	782	1,071	1,418	10	150	170	4	3%	45%	51%	1%	7%	10%	8%	5%	0%
Nineteen01	2016	\$2.47	261	---	831	1,235	1,799	0	121	130	11	0%	46%	50%	4%	10%	---	3%	7%	18%
<b>Total/Average:</b>	<b>2016</b>	<b>\$2.88</b>	<b>1,778</b>	<b>601</b>	<b>762</b>	<b>1,127</b>	<b>1,092</b>	<b>198</b>	<b>941</b>	<b>601</b>	<b>38</b>	<b>11%</b>	<b>53%</b>	<b>34%</b>	<b>2%</b>	<b>6%</b>	<b>3%</b>	<b>4%</b>	<b>6%</b>	<b>13%</b>

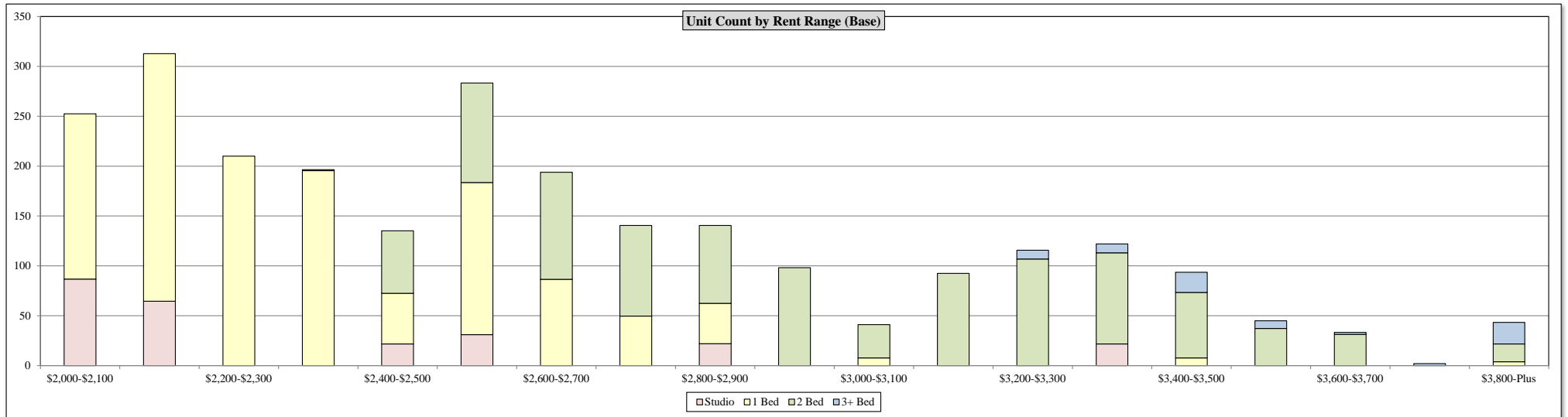


(1) Excludes projects in Lease-up  
(2) Represents availability of units as per leasing agents and community websites  
Source: Appendix A

**EXHIBIT 8C**  
**MF INVENTORY - FLOOR PLAN MIX**  
**SANTA ANA, COSTA MESA, ORANGE AND TUSTIN**  
**MAY 2020**

Units by Rent Range (Base)																					Total	
Bed Count	Under \$2,000	\$2,000 - \$2,100	\$2,100 - \$2,200	\$2,200 - \$2,300	\$2,300 - \$2,400	\$2,400 - \$2,500	\$2,500 - \$2,600	\$2,600 - \$2,700	\$2,700 - \$2,800	\$2,800 - \$2,900	\$2,900 - \$3,000	\$3,000 - \$3,100	\$3,100 - \$3,200	\$3,200 - \$3,300	\$3,300 - \$3,400	\$3,400 - \$3,500	\$3,500 - \$3,600	\$3,600 - \$3,700	\$3,700 - \$3,800	\$3,800 Plus	Num.	Share
0	92	87	65	0	0	22	31	0	0	22	0	0	0	0	22	0	0	0	0	0	340	12%
Share	27%	26%	19%	0%	0%	6%	9%	0%	0%	6%	0%	0%	0%	0%	6%	0%	0%	0%	0%	0%	1,304	48%
1	85	166	248	210	196	51	153	87	50	40	0	8	0	0	0	8	0	0	0	0	1,014	37%
Share	7%	13%	19%	16%	15%	4%	12%	7%	4%	3%	0%	1%	0%	0%	0%	1%	0%	0%	0%	0%	71	3%
2	0	0	0	0	1	63	100	107	91	78	98	33	92	107	91	66	37	31	0	0	18	0%
Share	0%	0%	0%	0%	0%	6%	10%	11%	9%	8%	10%	3%	9%	11%	9%	6%	4%	3%	0%	0%	22	2%
3	0	0	0	0	0	0	0	0	0	0	0	0	0	9	9	20	8	2	2	2	22	0%
Share	0%	0%	0%	0%	0%	0%	0%	0%	0%	0%	0%	0%	0%	12%	12%	28%	11%	3%	3%	30%	22	0%
<b>Total</b>	<b>177</b>	<b>252</b>	<b>313</b>	<b>210</b>	<b>197</b>	<b>135</b>	<b>283</b>	<b>194</b>	<b>141</b>	<b>141</b>	<b>98</b>	<b>41</b>	<b>92</b>	<b>116</b>	<b>122</b>	<b>94</b>	<b>45</b>	<b>33</b>	<b>2</b>	<b>43</b>	<b>2,729</b>	<b>100%</b>
Cumulative	6%	16%	27%	35%	42%	47%	57%	65%	70%	75%	78%	80%	83%	88%	92%	95%	97%	98%	98%	100%		

Units by Floor Plan Size Range																					Total	
Bed Count	Under 600	600 - 650	650 - 700	700 - 750	750 - 800	800 - 850	850 - 900	900 - 950	950 - 1,000	1,000 - 1,050	1,050 - 1,100	1,100 - 1,150	1,150 - 1,200	1,200 - 1,250	1,250 - 1,300	1,300 - 1,350	1,350 - 1,400	1,400 - 1,450	1,450 - 1,500	1,500 Plus	Num.	Share
0	203	0	72	22	0	0	22	0	0	22	0	0	0	0	0	0	0	0	0	0	340	12%
Share	60%	0%	21%	6%	0%	0%	6%	0%	0%	6%	0%	0%	0%	0%	0%	0%	0%	0%	0%	0%	1,304	48%
1	27	10	194	414	285	244	42	37	31	12	0	0	0	8	0	0	0	0	0	0	1,014	37%
Share	2%	1%	15%	32%	22%	19%	3%	3%	2%	1%	0%	0%	1%	0%	0%	0%	0%	0%	0%	0%	71	3%
2	0	0	0	0	0	0	0	0	54	146	249	231	197	54	47	0	22	0	2	13	18	0%
Share	0%	0%	0%	0%	0%	0%	0%	0%	5%	14%	25%	23%	19%	5%	5%	0%	2%	0%	0%	1%	22	0%
3	0	0	0	0	0	0	0	0	0	0	0	0	0	18	0	0	0	28	3	22	22	0%
Share	0%	0%	0%	0%	0%	0%	0%	0%	0%	0%	0%	0%	0%	25%	0%	0%	0%	40%	5%	31%	22	0%
<b>Total</b>	<b>230</b>	<b>10</b>	<b>266</b>	<b>435</b>	<b>285</b>	<b>244</b>	<b>64</b>	<b>37</b>	<b>85</b>	<b>179</b>	<b>249</b>	<b>231</b>	<b>197</b>	<b>79</b>	<b>47</b>	<b>0</b>	<b>22</b>	<b>28</b>	<b>5</b>	<b>35</b>	<b>2,729</b>	<b>100%</b>
Cumulative	8%	9%	19%	34%	45%	54%	56%	58%	61%	67%	76%	85%	92%	95%	97%	97%	98%	99%	99%	100%		



Source: Appendix A

EXHIBIT 8D

MF INVENTORY - AMENITIES  
SANTA ANA, COSTA MESA, ORANGE AND TUSTIN  
MAY 2020

**Project:** \_\_\_\_\_

**Nineteen01**

**Broadstone Arden**

**Eleven 10**

**Community Summary**

City	Santa Ana	Santa Ana	Orange
Address	1901 E 1st St	1951 E Dyer Road	1110 W. Town and Country Rd
Year Built	2016	2020	2018
Elevation	5	5	5
Units	261	335	260
Average Rent (\$)	\$2,495	\$3,063	\$2,571
Average Rent (\$/sf)	\$2.33	\$2.99	\$3.12
% 1-Beds	46%	19%	51%
% 2-Beds	50%	53%	28%

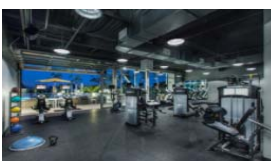
**Community Amenities**

Concierge Service	No	Yes	Yes
Business Center	Yes	Yes	Yes
Conference Room	No	Yes	Yes
Fitness Center	Yes	Yes	Yes + Outdoor Athletic Terrace
Cardio Room	Combined	Spin Studio	Combined
Weight Room	Combined	Yes	Combined
Yoga/Stretch Room	---	Yes	Outdoor Area
Game Room	Yes	Outdoor, Ping Pong / Billiards	Billiards / Shuffleboard
Kitchen/Clubhouse	Catering Kitchen / Games	Large, Catering Kitchen	Catering Kitchen
Pool	Rooftop / Cabanas	Resort Pool, Salt Room	Resort-Style Pool and Spa
Theater	TV Room	Outdoor Pool Theatre	No
Wi-Fi	Yes	Yes	Yes
Other Areas	Car Wash Station	Golf Simulator	Pet Spa and Dog Park
	Pet Spa and Dog Park	Coffee Lounge	Amazon parcel locker system
	Outdoor Cabanas w/ TVs	Day Spa	Outdoor Cabanas
	Bike Storage	Storage Units	

**Interior Spec**

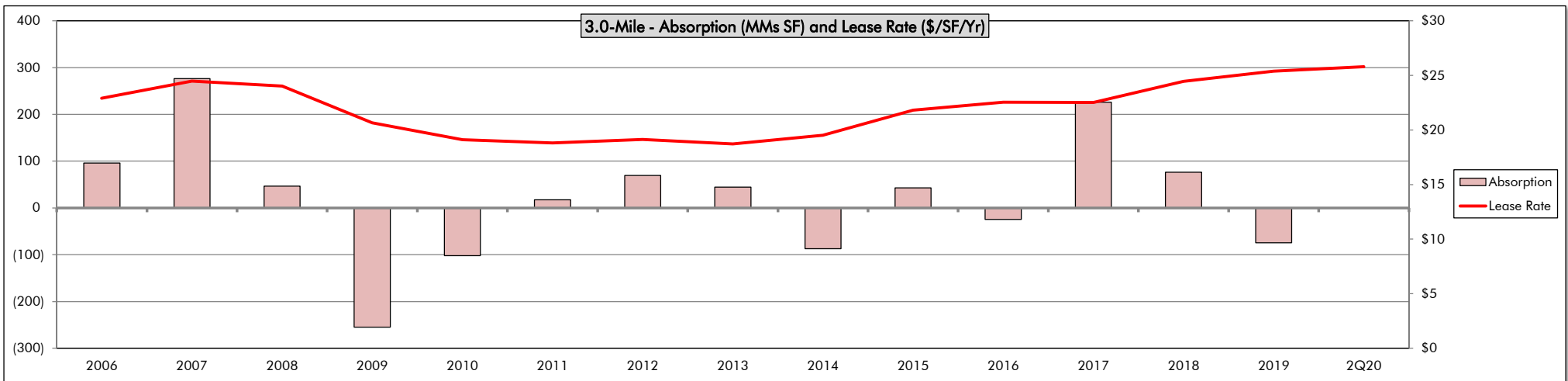
Kitchen			
Appliance	Stainless Steel	Stainless Steel	Stainless Steel
Counters	Quartz/Marble	Quartz	Quartz
Floor	Wood-Grain Finish	Wood Plank Style	Wood-Style
Cabinets	Contemporary	Contemporary	Contemporary
Backsplash	Full	Full	Full
Washer/Dryer In Unit	Stacked	Stacked	Stacked
Flooring (common)	Wood-Grain Finish	Wood Plank Style	Wood-Style
Balcony/Patio	In most units	Private Patios	In most units

**Pictures**



**EXHIBIT 9  
RETAIL PERFORMANCE  
ORANGE COUNTY  
2006 THROUGH SECOND QUARTER 2020**

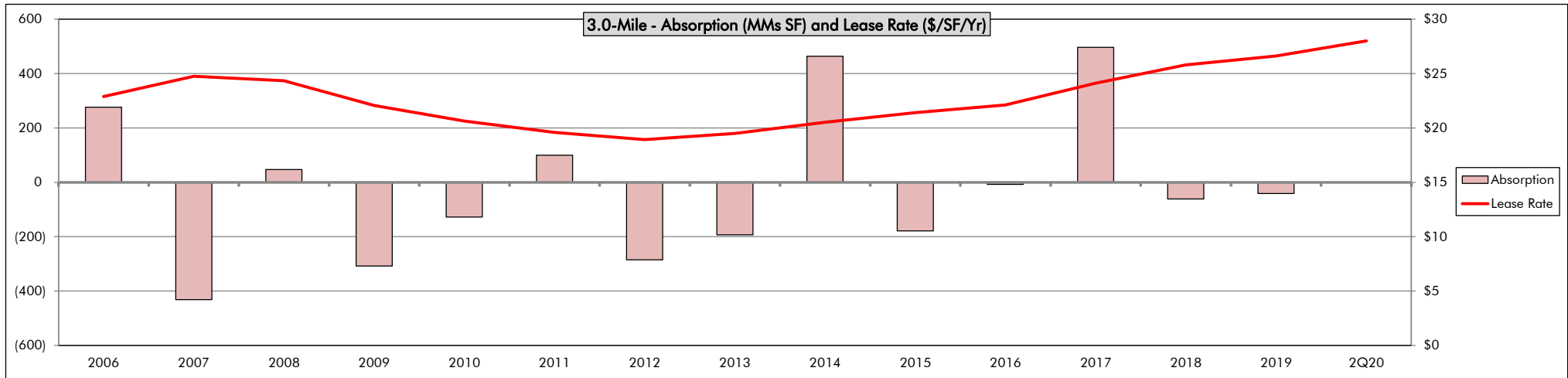
Period:	Annual														Annual Average		Quarterly		Under Const.	
	2006	2007	2008	2009	2010	2011	2012	2013	2014	2015	2016	2017	2018	2019	5-Yr	10-Yr	1Q20	2Q20	Num.	%Inv
<b>Inventory SF (MMs)</b>															<i>Growth (#)</i>					
Orange County	138.6	139.8	141.3	142.1	142.3	141.8	141.8	141.5	141.6	142.1	142.6	143.0	143.2	143.3	0.33	0.11	143.3	143.3	0.16	0.1%
Santa Ana	12.0	12.1	12.2	12.2	12.2	12.2	12.2	12.1	12.1	12.1	12.1	12.1	12.1	12.1	(0.00)	(0.01)	12.1	12.1	0.1	0.5%
3.0-Mile	12.0	12.0	12.1	12.1	12.1	12.1	12.1	12.1	12.1	12.1	12.1	12.1	12.2	12.2	0.03	0.01	12.2	12.2	0.01	0.0%
1.0-Mile	1.1	1.1	1.1	1.2	1.2	1.2	1.2	1.2	1.2	1.2	1.2	1.2	1.2	1.2	0.01	0.00	1.2	1.2	0.00	0.0%
% Santa Ana	9%	9%	9%	10%	10%	9%	10%	10%	10%	10%	10%	10%	10%	10%	-187%	-24%	10%	10%	0%	
<b>Occupancy</b>																				
Orange County	96.3%	96.6%	96.0%	94.2%	93.6%	94.0%	93.9%	94.4%	95.4%	96.0%	96.2%	95.9%	96.2%	<b>96.2%</b>	96.1%	95.2%	96.0%	<b>95.8%</b>		
Santa Ana	96.3%	96.8%	96.3%	95.4%	94.1%	94.2%	93.9%	93.4%	94.9%	95.6%	95.8%	95.7%	96.6%	96.3%	96.0%	95.0%	95.9%	96.3%		
3.0-Mile	95.0%	96.7%	97.2%	95.8%	94.0%	93.8%	94.3%	94.1%	94.9%	94.7%	94.6%	95.3%	96.6%	96.1%	95.4%	94.8%	95.8%	95.8%		
1.0-Mile	97.9%	97.6%	96.1%	92.4%	91.6%	92.0%	94.2%	94.9%	92.7%	93.3%	96.1%	96.7%	97.7%	97.1%	96.1%	94.6%	97.3%	97.1%		
<b>Absorption SF (000s)</b>																				
Orange County	987	1,965	(97)	(2,323)	(312)	100	295	790	1,206	1,685	47	145	716	(394)	440	428				
Santa Ana	134	64	60	(227)	3	(94)	(5)	27	52	111	(43)	(44)	134	(67)	18	7				
3.0-Mile	96	276	46	(255)	(102)	17	69	45	(87)	43	(24)	226	76	(74)	49	19				
1.0-Mile	18	(12)	(7)	(0)	(18)	7	46	(6)	(42)	46	15	28	(1)	3	18	8				
<b>Lease Rate</b>															<i>Growth (%)</i>					
Orange County	\$24	\$27	\$29	\$26	\$23	\$22	\$22	\$22	\$23	\$24	\$25	\$26	\$26	\$27	3.8%	0.6%	\$28.26	\$28.62		
Santa Ana	\$25	\$26	\$25	\$22	\$19	\$19	\$19	\$18	\$20	\$22	\$21	\$23	\$24	\$26	4.8%	1.7%	\$26.97	\$27.11		
3.0-Mile	\$23	\$24	\$24	\$21	\$19	\$19	\$19	\$19	\$20	\$22	\$23	\$23	\$24	\$25	5.4%	2.1%	\$26.37	<b>\$25.80</b>		
1.0-Mile	\$16	\$37	\$31	\$27	\$22	\$22	\$22	\$21	\$23	\$26	\$25	\$26	\$26	\$27	3.0%	0.1%	\$27.11	<b>\$30.23</b>		



Source: CoStar

**EXHIBIT 10  
OFFICE PERFORMANCE  
ORANGE COUNTY  
2006 THROUGH SECOND QUARTER 2020**

Period:	Annual														Annual Average		Quarterly		Under Const.	
	2006	2007	2008	2009	2010	2011	2012	2013	2014	2015	2016	2017	2018	2019	5-Yr	10-Yr	1Q20	2Q20	Num.	%Inv
<b>Inventory SF (MMs)</b>															<i>Growth (#)</i>					
Orange County	146.3	149.8	153.2	153.9	153.9	154.0	154.4	154.0	154.7	154.9	155.4	156.5	158.1	158.9	0.83	0.50	159.1	159.1	1.38	0.9%
Santa Ana	19.6	19.6	19.7	19.7	19.7	19.8	19.8	19.6	19.5	19.5	19.5	19.5	19.5	19.4	(0.02)	(0.03)	19.4	19.4	0.0	0.0%
3.0-Mile	21.6	21.7	21.8	21.9	22.0	22.0	22.0	21.8	21.7	21.8	21.8	21.9	21.9	21.9	0.03	(0.01)	21.8	21.8	0.19	0.9%
1.0-Mile	5.4	5.4	5.4	5.4	5.5	5.5	5.5	5.4	5.4	5.4	5.4	5.4	5.4	5.4	0.00	(0.01)	5.4	5.4	0.00	0.0%
% Santa Ana	27%	27%	27%	28%	28%	28%	28%	28%	28%	28%	28%	28%	28%	28%	0%	20%	28%	28%		
<b>Occupancy</b>															<i>Growth (%)</i>					
Orange County	93.1%	91.1%	87.8%	86.0%	84.5%	85.8%	87.0%	88.5%	89.1%	90.5%	91.4%	91.2%	90.5%	<b>90.4%</b>	90.8%	88.9%	90.4%	<b>90.3%</b>		
Santa Ana	93.8%	92.3%	90.0%	87.8%	87.5%	88.0%	87.4%	86.9%	87.0%	87.5%	87.6%	89.8%	90.1%	89.2%	88.8%	88.1%	88.5%	88.0%		
3.0-Mile	94.4%	93.6%	91.6%	90.5%	89.2%	89.3%	88.6%	88.4%	89.5%	89.8%	88.8%	90.2%	91.0%	90.7%	90.1%	89.5%	90.7%	90.4%		
1.0-Mile	95.7%	93.5%	89.1%	87.3%	85.0%	86.2%	85.0%	86.5%	88.1%	88.6%	89.1%	88.4%	89.2%	88.4%	88.7%	87.4%	87.7%	87.0%		
<b>Absorption SF (000s)</b>															<i>Growth (%)</i>					
Orange County	700	(852)	(1,001)	(3,581)	(472)	2,900	2,054	1,193	2,880	1,572	1,582	243	620	245	852	1,282				
Santa Ana	86	(586)	(167)	(338)	33	58	(25)	(487)	244	(162)	393	333	(115)	(392)	12	(12)				
3.0-Mile	276	(432)	47	(308)	(128)	99	(285)	(193)	463	(179)	(8)	497	(61)	(42)	41	16				
1.0-Mile	154	(267)	(43)	(99)	(4)	40	(55)	1	85	(43)	160	(77)	(15)	(53)	(5)	4				
<b>Lease Rate</b>															<i>Growth (%)</i>					
Orange County	\$28	\$30	\$29	\$26	\$24	\$23	\$22	\$22	\$24	\$26	\$27	\$29	\$31	\$32	5.9%	2.0%	\$32.26	\$32.76		
Santa Ana	\$24	\$25	\$25	\$22	\$21	\$20	\$19	\$19	\$20	\$21	\$22	\$23	\$25	\$27	6.1%	1.9%	\$28.13	\$27.82		
3.0-Mile	\$23	\$25	\$24	\$22	\$21	\$20	\$19	\$20	\$21	\$21	\$22	\$24	\$26	\$27	5.3%	1.9%	\$27.30	<b>\$28.01</b>		
1.0-Mile	\$23	\$23	\$23	\$23	\$21	\$19	\$19	\$19	\$20	\$21	\$20	\$22	\$24	\$26	5.2%	1.3%	\$28.24	<b>\$28.69</b>		

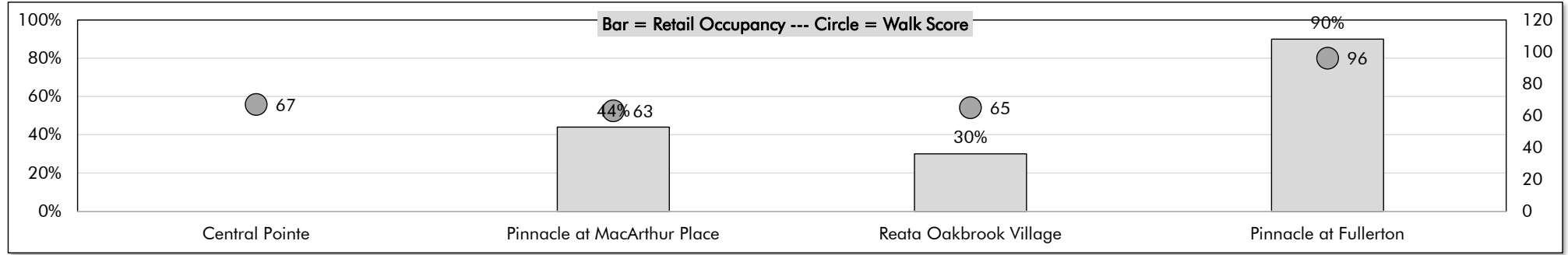


Source: CoStar

**EXHIBIT 11**  
**MIXED-USE ANALOGS**  
**SANTA ANA, LAGUNA HILLS AND FULLERTON**  
**MAY 2020**

Project Name City Street	Central Pointe Santa Ana 4th & Cabrillo Park Dr	Pinnacle at MacArthur Place Santa Ana 31 E. MacArthur Cres	Reata Oakbrook Village Laguna Hills 24391 Avenida de la Carlota	Pinnacle at Fullerton Fullerton 229 E. Commonwealth Ave
<b>Project Description</b>				
Year Built	TBD	2001	2016	2004
Elevation	5-stories	4-stories	4-stories	4-stories
Apartments	644	253	289	192
Retail (SF)	15,200	14,000	12,000	8,500
Parking				
Garage	Wrap - 7-stories	Semi-Sub Podium	Semi-Sub Podium	Semi-Sub Podium
Street	20-spaces	25-spaces	Unlimited Spaces	8-spaces
<b>Retail Performance</b>				
Occupancy	<b>TBD</b>	<b>44%</b>	<b>30%</b>	<b>90%</b>
<b>Visibility</b>				
Primary Frontage Street	4th Street	MacArthur Boulevard	Avenida de la Carlota	Commonwealth Avenue
Walk Score	<b>67</b>	<b>63</b>	<b>65</b>	<b>96</b>
Traffic Count	<b>23,000</b>	<b>36,000</b>	<b>15,000</b>	<b>24,000</b>

Picture



Source: CoStar; OCTA; TCG



# FISCAL IMPACT ANALYSIS



17872 GILLETTE AVE.  
SUITE 350  
IRVINE, CA 92614

714 541 4585  
INFO@WEBRSG.COM  
WEBRSG.COM

June 3, 2020

Via Electronic Mail

Michael D. Reynolds, Principal  
THE CONCORD GROUP  
369 San Miguel Drive, Suite 265  
Newport Beach, CA 92660

**DEVELOPMENT FISCAL IMPACT ANALYSIS  
CENTRAL POINTE MIXED-USE PROJECT, SANTA ANA**

Dear Mr. Reynolds:

RSG, Inc. (“RSG”) was retained by The Concord Group (“TCG”) to perform a fiscal and economic impact analysis for the development of a proposed mixed-use apartment and retail project (“Project”) in Santa Ana, California. TCG obtained this analysis on behalf of the property owner/developer, Arnel & Waterford Property Company (“Developer”), which recently submitted an application for redevelopment of the subject property with the City of Santa Ana’s (“City”) Planning and Building Services Department.

The Project site sits along 4<sup>th</sup> Street, between the Santa Ana (Interstate 5) Freeway (“I-5”) and Cabrillo Park Drive. The gross site area is approximately 8.35 acres, and is made up of four vacant parcels. If approved, the Project would consist of two five-story mixed-used buildings divided by a central park and open walk space. Attached to the buildings would be two seven-story parking structures. On the ground floor of each building would be a total 15,200 square feet of retail space.

This letter describes our analysis, methodology, and anticipated recurring fiscal impacts resulting from development of the Project. As is typical at this stage, our conclusions could evolve as the application moves forward through the design and environmental review process.

As is consistent with other Santa Ana projects analyzed by RSG, the construction period was assumed to be over three years. Part of the work would begin in 2021 (36 percent), with a majority taking place in 2022 (51 percent), leading to the remainder in 2023 (13 percent). The Project would open in the third construction year. Fiscal impacts from that year are reduced to reflect a partial year.

Overall, RSG anticipates the following fiscal outcomes over a 25-year forecast period:

- Gross General Fund revenues of approximately \$23.1 million, (net present value, discounted at 4 percent), including:
  - \$10.3 million (net present value, discounted at 4 percent) in net new property tax revenues to the City General Fund.
  - A combined \$3.6 million in sales taxes that includes \$1.8 million from the City’s base rate, as well as an additional \$1.8 million from the City’s Measure X additional tax rate through the sunset in 2039 (net present value, discounted at 4 percent).

- A total of \$23.1 million (net present value, discounted at 4 percent) in additional City General Fund revenue, including construction period revenues, recurring site-specific tax, and other Project impacts.
- City General Fund expenditures associated with the Project total \$7 million (net present value, discounted at 4 percent)
- As a result, the net new General Fund revenue (revenues less expenditures) is projected to be approximately \$16.1 million (net present value, discounted at 4 percent) if the Project were developed as proposed.

Table 1 summarizes the 25-year fiscal impact of the Project. Table 2 provides the corresponding forecast of the same impacts on the following page.

**Table 1**

**NET NEW RECURRING GENERAL FUND FISCAL IMPACTS**

Central Pointe, Santa Ana

Revenue Category	25-Year Recurring	
	Nominal	NPV 4.0%
Property Tax	\$ 18,505,380	\$ 10,333,353
Property Tax In-Lieu	12,096,754	6,756,731
Utility User Tax	3,537,877	1,884,715
Sales Tax	3,479,170	1,853,440
Measure X (2018) Sales Tax Increase	2,753,009	1,786,920
Business Tax	927,121	493,901
<b>Total Revenues</b>	<b>\$ 41,299,312</b>	<b>\$ 23,109,059</b>
Less City Expenditures	\$(13,214,039)	\$(7,026,724)
<b>NET NEW REVENUE TOTAL</b>	<b>\$ 28,085,273</b>	<b>\$ 16,082,335</b>

Sources: City of Santa Ana, County of Orange, California State Board of Equalization, ESRI Business Analyst Online, and RSG, Inc.

**Table 2**

**25-YEAR NET NEW RECURRING FISCAL IMPACT PROJECTIONS**  
 Central Pointe, Santa Ana

Year	Net New Property Tax	Property Tax In-Lieu	Utility User Tax	Sales Tax	Measure X (2018) Additional Sales Tax	Business Tax	Gross Revenue	City Expenditures	Net New Total
CY1 2021	\$ 205,735	\$ 138,575	\$ -	\$ -	\$ -	\$ -	\$ 344,309	\$ -	\$ 344,309
CY2 2022	462,569	302,985	-	-	-	-	765,554	-	765,554
CY3 2023	529,747	346,150	91,766	90,244	135,366	24,048	1,217,321	(307,968)	909,354
1 2024	540,342	353,073	94,519	92,951	139,427	24,769	1,245,082	(353,986)	891,096
2 2025	551,149	360,135	97,355	95,740	143,609	25,512	1,273,500	(364,606)	908,895
3 2026	562,172	367,337	100,276	98,612	147,918	26,278	1,302,593	(375,544)	927,049
4 2027	573,416	374,684	103,284	101,570	152,355	27,066	1,332,375	(386,810)	945,565
5 2028	584,884	382,178	106,383	104,617	156,926	27,878	1,362,866	(398,414)	964,451
6 2029	596,582	389,821	109,574	107,756	161,634	28,715	1,394,081	(410,367)	983,714
7 2030	608,513	397,618	112,861	110,988	149,668	29,576	1,409,225	(422,678)	986,547
8 2031	620,684	405,570	116,247	114,318	154,158	30,463	1,441,440	(435,358)	1,006,082
9 2032	633,097	413,682	119,734	117,748	158,783	31,377	1,474,421	(448,419)	1,026,002
10 2033	645,759	421,955	123,326	121,280	163,546	32,318	1,508,186	(461,872)	1,046,314
11 2034	658,674	430,394	127,026	124,918	168,453	33,288	1,542,754	(475,728)	1,067,026
12 2035	671,848	439,002	130,837	128,666	173,506	34,287	1,578,146	(489,999)	1,088,147
13 2036	685,285	447,782	134,762	132,526	178,711	35,315	1,614,382	(504,699)	1,109,682
14 2037	698,990	456,738	138,805	136,502	184,073	36,375	1,651,483	(519,840)	1,131,642
15 2038	712,970	465,873	142,969	140,597	189,595	37,466	1,689,470	(535,436)	1,154,034
16 2039	727,230	475,190	147,258	144,815	195,283	38,590	1,728,366	(551,499)	1,176,867
17 2040	741,774	484,694	151,676	149,159	-	39,748	1,567,051	(568,044)	999,007
18 2041	756,610	494,388	156,226	153,634	-	40,940	1,601,798	(585,085)	1,016,713
19 2042	771,742	504,276	160,913	158,243	-	42,168	1,637,342	(602,638)	1,034,704
20 2043	787,177	514,361	165,740	162,990	-	43,433	1,673,702	(620,717)	1,052,985
21 2044	802,920	524,648	170,713	167,880	-	44,736	1,710,898	(639,338)	1,071,559
22 2045	818,979	535,141	175,834	172,916	-	46,078	1,748,949	(658,518)	1,090,431
23 2046	835,358	545,844	181,109	178,104	-	47,461	1,787,876	(678,274)	1,109,602
24 2047	852,066	556,761	186,542	183,447	-	48,885	1,827,700	(698,622)	1,129,078
25 2048	869,107	567,896	192,139	188,950	-	50,351	1,868,443	(719,581)	1,148,862
<b>TOTAL</b>	\$ 18,505,380	\$ 12,096,754	\$ 3,537,877	\$ 3,479,170	\$ 2,753,009	\$ 927,121	\$ 41,299,312	\$ (13,214,039)	\$ 28,085,273
<b>NPV 4.00%</b>	\$ 10,333,353	\$ 6,756,731	\$ 1,884,715	\$ 1,853,440	\$ 1,786,920	\$ 493,901	\$ 23,109,059	\$ (7,026,724)	\$ 16,082,335
Inflation Rate	2.0%	2.0%	3.0%	3.0%	3.0%	3.0%	3.0%	3.0%	

## PROJECT DESCRIPTION

The Project site is situated just east of the I-5 Freeway on 4<sup>th</sup> Street at Cabrillo Park Drive, south of Parkcourt Place. The Project sits at the northern border of the MEMU zone. It is 1.7 miles east of Downtown Santa Ana. Santa Ana's Saddleback View neighborhood lies across I-5 to the west while Marbury Park neighborhood is to the north. Office/professional uses are located to the east, and located south across 4<sup>th</sup> Street is the California Department of Transportation (Caltrans) District 12 office building and other uses. The Project is also one block away from the relatively new Nineteen01 multifamily project at the corner of First Street and Cabrillo Park Drive.

Figure 1 shows the location of the Project Site.

**Figure 1: Project Site**



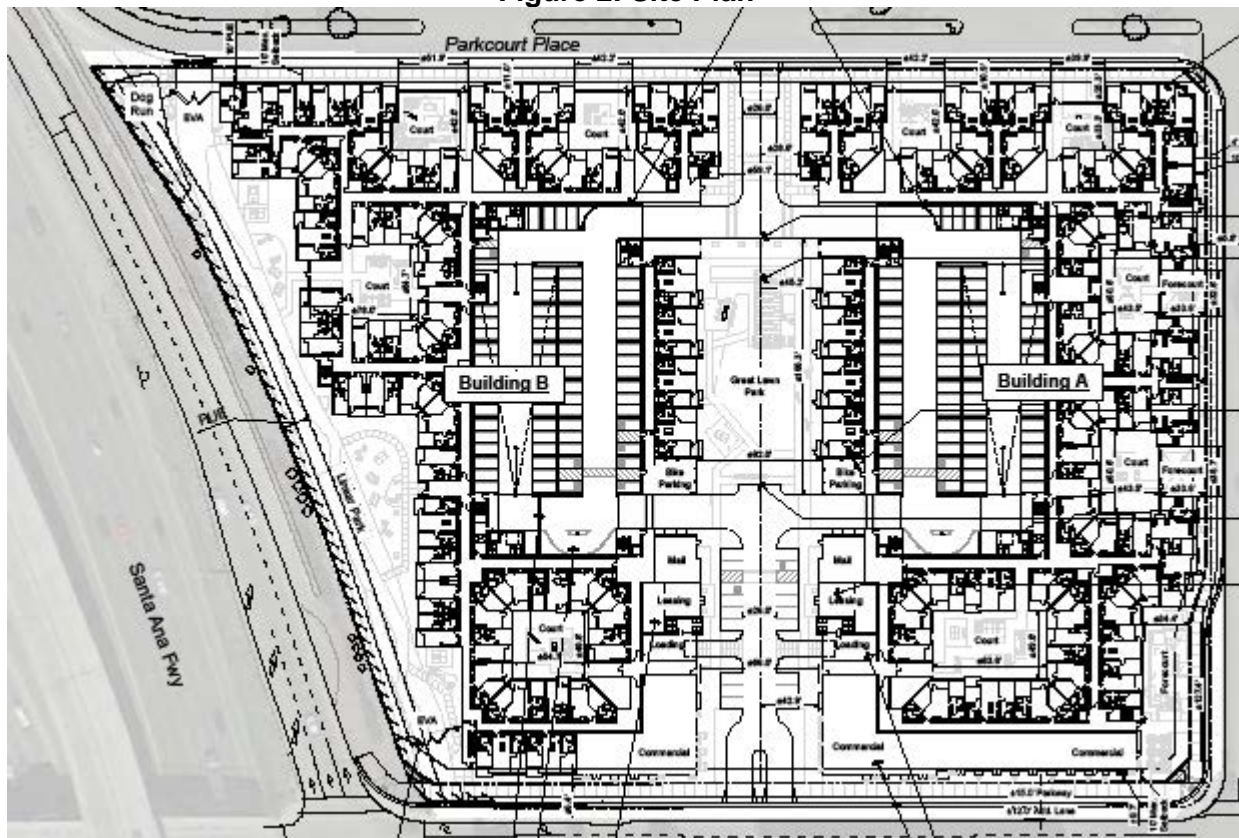
Source: Google Maps

According to the Developer this is the City's Metro East Mixed-Use ("MEMU") Overlay Zone, as well as its Active Urban District. The MEMU zone was created in 2007 by the Santa Ana Planning Commission to foster the development of more active commercial and residential projects. The zone encourages the construction of modern and urban architecture, with plentiful open space.

As shown in Figure 2, the 576,000 square foot (gross building area) Project would result in the construction of 644 market rate multifamily units, 15,200 square feet of ground floor retail space, and two seven-story parking structures with a combined 1,318 spaces.

Both buildings contain similar amenities. The eastern structure, building A, would host 318 units, 580 parking spaces, and retail space of 9,600 square feet. Five courtyards checker this building's outdoor open space. The western structure (building B) would host 319 units and 638 parking spaces. The building would also have 5,600 square feet for retail on the ground floor. Just outside of the building would be open space divided into four courtyards, an Emergency Vehicle Access lane ("EVA"), a small dog run, and a park looking out on the I-5 Freeway. Between both buildings would be a resident park and paved pedestrian walkways leading to 4<sup>th</sup> Street and Parkcourt Place.

**Figure 2: Site Plan**



Source: KTG Y Group Inc., Arnel & Waterford Property Co.

Figure 3 presents a rendering of the project as currently proposed:

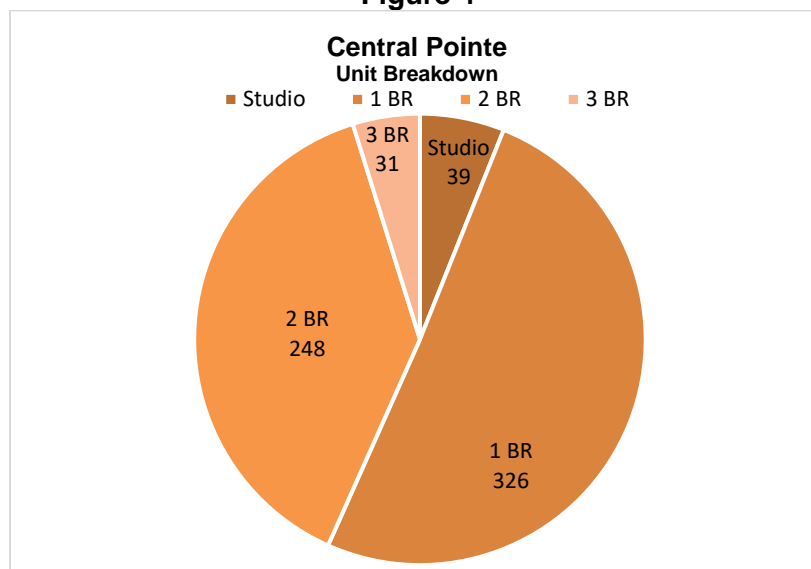
Figure 3



The proposed 644 unit market-rate project includes 39 studios (6 percent of all units), 326 one-bedroom (51 percent), 284 two-bedroom (39 percent), and 31 three-bedroom (5 percent) units.

Figure 4 exhibits the unit mix:

Figure 4



Source: KTG Group Inc., Arnel & Waterford Property Co.

## RECURRING FISCAL IMPACTS

### *Property Tax Revenue*

All property taxes in the state of California are levied at a rate of 1 percent. The City's share of the 1 percent property tax levy is 19.4%, as provided by the County of Orange ("County") Auditor-Controller. The Developer provided RSG with the Project costs that consisted of \$42 million for land, and \$203 million for hard and soft costs. This \$245 million adjusted for inflation over the construction period, would amount to an assessed valuation of \$279 million at buildout.

To accurately portray the effect of the Project to the City, property tax revenues presented in this report are net of any existing revenues. The existing site is currently valued at \$5.5 million. When adjusted for inflation over the construction period the value is \$6 million, providing the City an estimated \$11,691 in year 2023 absent the construction of the Project. The new development would provide \$541,438 to the City in that same year. Therefore, the net new property tax revenues to the City would be **\$529,747** at buildout.

**Table 3**

<b>NET NEW PROPERTY TAX REVENUE</b>		
Central Pointe, Santa Ana		
<b>At Buildout</b>		
Existing Assessed Value	\$	6,026,240
Proposed Project Assessed Valuation <sup>1</sup>		279,091,931
<b>Net New Value</b>	<b>\$</b>	<b>273,065,691</b>
City Property Tax Rate		19.4%
		<i>Annual Estimate</i>
Existing Property Tax Revenues	\$	11,691
New Property Tax Revenues	\$	541,438
<b>Net New Property Tax Revenues</b>	<b>\$</b>	<b>529,747</b>

Source: County of Orange Auditor Controller, RSG, Inc.

<sup>1</sup> Inflated pursuant to the construction schedule

To project future property taxes, RSG assumed 2 percent inflation on property tax revenues over the 25-year projection period, resulting in **\$10.3 million** (net present value, discounted at 4 percent) in net new property tax revenues for the City General Fund.

### *Property Tax in-lieu of Motor Vehicle License Fee Revenue*

Established in 1935, the Motor Vehicle License Fee ("MVLFF") was essentially a tax on vehicle ownership. It is collected by the State annually when vehicles are registered and was historically allocated to cities and counties based upon a statutory formula. In 2004, during the State's budget crisis, about 90 percent of each city's MVLFF revenue was replaced with property tax revenue, and cities in particular began to receive an allocation of property tax from the Educational Revenue



Augmentation Fund (“ERAF”) in an amount equal to what they would have received in MVLF under an older MVLF allocation formula. Under current law, the property tax in-lieu of MVLF revenue increases based on assessed value growth in a jurisdiction, so estimated revenues are based on changes in assessed value created by the Project.

Based on the City’s 2019-20 secured property tax roll, the total assessed value of all Property in the City is \$26.3 billion. When adjusting for inflation during the construction period, the Project’s net new assessed valuation (\$273 million) increases the City’s assessed value by 1.06 percent. The MVLF increase from the Project is calculated from the percent increase in assessed value. This gives us **\$346,150** in estimated In-Lieu MVLF revenues at build-out (see Table 4). As depicted above, the City is expected to receive **\$6.8 million** (net present value, discounted at 4 percent) in In-Lieu MVLF revenues through 2048.

**Table 4**

<b>PROPERTY TAX IN-LIEU OF MOTOR VEHICLE LICENSE FEES</b>		
Central Pointe, Santa Ana		
2019-20 City Assessed Value	\$	26,369,891,977
Project Assessed Value <sup>1</sup>		279,091,931
<hr/>		
City Assessed Value with Project		26,648,983,908
<hr/>		
Increase in Assessed Value		1.06%
<hr/>		
Santa Ana 2019-20 VLF		32,705,877
Santa Ana VLF with Project		33,052,028
<hr/>		
<b>Property Tax In-lieu Revenue</b>	<i>Annual Estimate</i> \$	<b>346,150</b>

Source: County of Orange Auditor Controller, RSG, Inc.

<sup>1</sup> Inflated pursuant to the construction schedule

**Utility User Tax**

The City assesses a utility user tax of 5.5 percent on electricity, gas, water, and telephone revenues generated within Santa Ana. Utility costs were estimated by RSG based on a review of similar projects and utility costs in Orange County. Residential utility expenditures were assumed to be: \$104 per month for phone, \$75 for electricity, \$23 for gas, and \$38 for water. This amounts to \$3,260 annually in 2020 dollars. From the Developer’s estimates of 15,200 square feet of retail, RSG was able to use US Energy Information Administration (“EIA”) estimates to extrapolate commercial utility expenses. Retail establishments average around \$1.50 per square foot in energy expenses, amounting to \$22,797 annually for the Project.

Based on these assumptions, RSG estimates that utility user tax revenues generated by the Project, reduced to account for a partial year, would be an estimated **\$91,766** at buildout. This adds up to **\$1.9 million** (net present value, discounted at 4 percent) over the 25-year projection period (see Table 2).

Table 5 showcases the Utility User Tax at buildout below.

**Table 5**

<b>UTILITY USER TAX REVENUE</b>		
Central Pointe, Santa Ana		
Energy Expenditures per Household	\$	3,260
Occupied Households		581
<b>Total Residential Energy Expenses</b>	<b>\$</b>	<b>1,894,998</b>
<b>Total Commercial Energy Expenses<sup>1</sup></b>	<b>\$</b>	<b>22,797</b>
<b>City Tax Rate</b>		<b>5.5%</b>
Full-Year Buildout Revenues	\$	105,479
<b>Partial-Year Buildout Revenues</b>	<b>\$</b>	<b>91,766</b>

Sources: US Energy Information Administration, RSG, Inc., ESRI BAO

<sup>1</sup>EIA estimates of \$1.50 per SF for Retail

### **Sales Taxes**

The Project is expected to increase sales taxes through both the new businesses and new residents. The methodology and assumptions for both differ but are necessary for accuracy.

#### Resident-Derived Sales Tax

To determine the resident share, RSG obtained average annual household expenditures for households within a 1-mile radius of the Project from ESRI Business Analyst. By adjusting the household expenditures based on taxable and non-taxable sales, RSG estimates that each household would spend an average of \$17,836 at buildout. Based on experience with previous projects in the City, an estimated 60 percent of those expenditures would be subject to Santa Ana's sales tax.

The State and County sales tax receive 6 percent and 0.75 percent of taxable sales, respectively. In addition, the City levies its own sales tax at a rate of 1 percent. In 2018, Santa Ana voters approved an additional sales tax of 1.5 percent that would then decrease to 1 percent in 2029 until sunseting in 2039. RSG took this increase into consideration when analyzing the affects the new residents would have on the City's General Fund.

Using ESRI's Business Analyst Online software, RSG was able to estimate the amount of taxable expenditures the average new household would make in the City. That number was then multiplied by the number of occupied households (581). This provided an estimate of total taxable sales of \$6.2 million. From there, the taxable sales were multiplied by both the City's base tax rate and the Measure X additional rates (1 percent and 1.5 percent). Therefore, the residential derived sales tax revenue from the base tax rate is an estimated **\$62,205** at buildout. The

additional tax from Measure X would yield **\$93,307** at buildout and decrease to **\$74,276** in 2029 (adjusted for 3% inflation) before ceasing in 2039.

**Table 6**

**RESIDENT-DERIVED SALES TAX REVENUE**  
Central Pointe, Santa Ana

<b>Households and Sales at Buildout</b>		
Average Household Taxable Expenditures	\$	17,836
Occupied Households		581
Percent within Santa Ana		60%
<b>Total Taxable Sales</b>	<b>\$</b>	<b>6,220,479</b>
City Share of Sales Tax		1%
Measure X (2018) Additional Sales Tax <sup>1</sup>		1.5%
<b>Resident-Derived Sales Tax Revenues</b>	<i>Annual Estimate</i>	
<b>(Base Rate)</b>	<b>\$</b>	<b>62,205</b>
<b>(2018 Addition)</b>	<b>\$</b>	<b>93,307</b>
<b>(2029 Decrease to 1%)</b>	<b>\$</b>	<b>74,276</b>

Source: ESRI BAO, City of Santa Ana  
<sup>1</sup>Measure X additional sales tax decreases from 1.5% to 1% in 2029

Business-Derived Sales Tax

The Project includes 15,200 square feet of retail space. The new businesses would generate sales taxes separate from the new residents. Since the Developer does not yet know the exact tenants that would fill the space, RSG estimated an average of \$250 of sales per square foot for the space. As a result, the retail businesses would generate taxable sales of \$3.8 million at buildout.

RSG estimates the base sales tax revenues at buildout to be **\$41,524**. Table 7 below presents this information. In addition, Measure X would generate **\$62,285** for that year as well. However, in 2029 Measure X revenues would decrease to **\$51,069** before being eliminated altogether in 2039.

Table 7

**BUSINESS-DERIVED SALES TAX REVENUE**

Central Pointe, Santa Ana

<b>Sales at Buildout</b>		
General Retail	\$	3,800,000
<hr/>		
City Share of Sales Tax		1%
Measure X (2018) Additional Sales Tax <sup>1</sup>		1.5%
<hr/>		
<b>Business-Derived Sales Tax Revenues</b>	<i>Annual Estimate</i>	
<b>(Base Rate)</b>	\$	<b>41,524</b>
<b>(2018 Addition)</b>	\$	<b>62,285</b>
<b>(2029 Decrease to 1%)</b>	\$	<b>51,069</b>

Source: California State Board of Equalization, RSG, Inc.

<sup>1</sup>Measure X additional sales tax decreases from 1.5% to 1% in 2029

For the City base rate, combined resident and business sales taxes at buildout would be an estimated \$90,244. Measure X combined taxes would be \$135,366. Both are adjusted for inflation during the construction period and for the partial year at opening. This provides for a 25-year total of \$1.8 million from the base rate and \$1.8 million from Measure X (net present value, discounted at 4 percent).

**Business Tax**

The City assesses a business tax on retail stores and residential property management companies. Table 8 below showcases the new revenues from the Project. Retail business taxes are assessed based on annual sales while management company business taxes are assessed based on unit count. The combined business tax revenues are an estimated **\$24,048** at buildout, or **\$493,901** over 25 years (net present value, discounted at 4 percent).

Table 8

**BUSINESS TAX REVENUES**

Central Pointe, Santa Ana

Multifamily Residential Tax	\$	24,739
Retail Tax		2,902
<hr/>		
Full-Year Business Taxes at Buildout	\$	28,786
<b>Partial-Year Business Taxes at Buildout</b>	<b>\$</b>	<b>24,048</b>

Sources: City of Santa Ana, RSG, Inc

## CITY EXPENDITURES

---

RSG estimated the additional population that would move into the Project to estimate the total added expenditures to the City General Fund for servicing the new residents. Consistent with other recent analyses prepared by RSG on projects in Santa Ana, RSG assumed that each studio would house 1.25 residents, each one-bedroom unit would house 1.75 residents, each two-bedroom unit would house 3.25 residents, and each three-bedroom unit would house 4 residents. Overall, this works out to an average household size of 2.41 residents per unit, which RSG considers reasonable for this particular Project.

RSG estimates at full occupancy the Project could hold 1,550 residents. Taking into account that a small percentage of the units will normally be vacant due to turnover, we estimate the fiscal impacts based on residents' time spent in the City. This is done by calculating the full-time equivalent (FTE) residents, defined as those who spend a vast majority of their daily consumption in Santa Ana. The assumption being that new residents who work out of the City, do not consume products in the City during the time they are gone.

RSG gathered data from the US Census and ESRI Business Analyst Online to estimate the FTE residents of the Project. Approximately 13 percent of Santa Ana residents work within Santa Ana, which, in effect means that the City is servicing these resident-employees 100 percent of the time. Another 37 percent of Santa Ana residents work outside the city. Assuming the residents that work outside of the city are outside City limits from 9 am to 5 pm, Santa Ana is servicing these residents approximately 73 percent of the time. The city's remaining residential population (about 51 percent), is serviced by the City 100 percent of the time. Accounting for all residents and employees based on the percent of time spent in the city, the Project would generate a daily (24/7) population of 1,399 persons.

RSG identified variable costs, as opposed to fixed costs, by department in the City of Santa Ana FY 2019-20 Adopted Budget. Variable costs are City expenditures that increase or decrease based on the resident and employee population. The City Manager and City Attorney offices, for example, are fixed costs that would not vary based on population, but the Police and Fire departments would vary based on population. With that said, RSG estimates expenditure increases of **\$353,986** during the first full year of operations. Over a 25-year projection period, the Project would add **\$7 million** in City expenditures (net present value, discounted at 4 percent).

Table 9

**SUMMARY OF RECURRING CITY EXPENDITURES<sup>1</sup>**

**CITY OF SANTA ANA**  
Central Pointe, Santa Ana

<b>City Department</b>	<b>Current City Expenditures<sup>2</sup></b>	<b>Project-derived City Expenditures</b>	<b>Total City Expenditures<sup>3</sup></b>	<b>Percent Increase</b>
City Manager's Office	\$ 2,708,440	\$ -	\$ 2,708,440	0.00%
Non-Departmental & Interfund Transfers	61,098,660	-	61,098,660	0.00%
Clerk of the Council Office	1,682,560	50	1,682,610	0.00%
City Attorney's Office	3,219,780	-	3,219,780	0.00%
Personnel Services	2,490,360	148	2,490,508	0.01%
Finance & Management Services	9,671,190	671	9,671,861	0.01%
Bowers Museum Corporation	1,473,430	-	1,473,430	0.00%
Parks, Recreation and Community Services	26,836,790	4,560	26,841,350	0.02%
Police Department	131,568,820	223,291	131,792,111	0.17%
Fire Services	45,640,920	95,156	45,736,076	0.21%
Planning & Building Agency	13,227,380	71	13,227,451	0.00%
Public Works Agency	13,155,830	-	13,155,830	0.00%
Community Development Agency	3,353,520	-	3,353,520	0.00%
<b>Total in FY 2020-21</b>	<b>\$ 316,127,681</b>	<b>\$ 323,947</b>	<b>\$ 316,451,627</b>	<b>0.10%</b>
<b>Total in 2023-24</b>		<b>\$ 353,986</b>		

<sup>1</sup> For this analysis, RSG identified departmental costs in the City of Santa Ana FY 2019-20 Budget that are variable costs, as opposed to fixed costs. Variable costs are expenditures by the City that increase or decrease based on the residential and employee population in the City. For example, City Council and Human Resources salaries and wages generally are fixed costs that do not vary based on population. Meanwhile, the Fire Services and Parks & Community Services departments will likely experience service cost increases due to the added population.

<sup>2</sup> Current expenditures are based on adopted expenditures in the City of Santa Ana's FY 2019-20 Budget.

<sup>3</sup> Sum of current City expenditures and project-derived City expenditures. Assuming project opened in 2020-21.

Sources: City of Santa Ana, RSG, Inc., US Census Bureau

## EMPLOYMENT

Development and ongoing operation of the Project would generate employment opportunities, add labor income to the market area, and add value to the gross regional product. For this analysis, RSG used the IMPLAN model to measure the economic impacts of the Project using County-wide data. IMPLAN is an input-output analysis software tool that tracks the interdependence among various producing and consuming sectors of the economy. According to MIG, Inc., the creators of IMPLAN, the software measures the relationship between a given set of demands for final goods and services and the inputs required to satisfy those demands. IMPLAN publishes countywide data on an annual basis; this analysis utilized the most recent available County of Orange dataset (2018) to calculate direct, indirect, and induced impacts.

The IMPLAN inputs are investment (development costs) and gross business operating income of the Project and the resulting outputs are economic impacts, including employment generation, labor income, and gross regional product. Jobs are the primary impacts calculated by IMPLAN.

RSG analyzed both temporary and permanent economic impacts. For temporary construction impacts the Developer's Project costs exclusive of land costs were used (\$203 million). From there construction costs were divided based on the gross building area for the between multi-

family (97 percent) and non-residential (3 percent) components. For permanent impacts, the estimated sales from the residential complex, and the retail space were used. IMPLAN breaks down the resulting employment and other effects into three categories: direct, indirect, and induced:

- Direct Effects – Refers to the direct effects that occur on the Project site may result from development costs and operational sales revenue.
- Indirect Effects – Changes in sales, jobs, and/or income within the businesses that may supply goods and services to the Project. Indirect effects do not occur directly on the Project-site but are an indirect effect to surrounding or related businesses.
- Induced Effects – Regional changes resulting from additional spending that may be earned either directly or indirectly from the Project.

RSG utilizes the FTE conversion of total employment generally preferred in Public Policy. FTE employment numbers, as opposed to residents, present total employment through the lens of hours worked; summarizing then dividing by how many 40-hour work weeks are generated by the investment. The IMPLAN analysis concludes that the temporary construction component of the Project would result in 1,300 direct FTE jobs, 117 indirect FTE jobs, and 544 induced FTE jobs the majority of which would be in Santa Ana.

The permanent impacts attributed to the Project are 69 FTE jobs related to the operations of both the residential building itself, as well as the retail component of the Project. This includes 48 direct, 8 indirect, and 13 induced jobs to the region.

Table 10 outlines the aforementioned FTE jobs generated by the Project.

**Table 10****PROJECTED EMPLOYMENT (FTE)**

4th and Cabrillo

Temporary (Construction) Jobs	
Direct	1300
Indirect	117
Induced	544
<b>Subtotal</b>	<b>1961</b>
Permanent Jobs	
Direct	48
Indirect	8
Induced	13
<b>Subtotal</b>	<b>69</b>
<b>Total Temporary &amp; Permanent Jobs</b>	
Direct	1349
Indirect	125
Induced	556
<b>Total</b>	<b>2030</b>

*Source: IMPLAN*

In closing, it is our privilege to assist The Concord Group and your client Arnel & Waterford Property Company with predevelopment activities on this project. Please let us know if you have any questions or comments pertaining to the findings of this report.

Sincerely,



James Simon, Principal



# APPENDIX

## APPENDIX A

SURVEY - APARTMENTS  
SANTA ANA, COSTA MESA, ORANGE AND TUSTIN  
MAY 2020

Project Name/ Manager/ Address	Units/ Elev.	Occ./ Year Built/ Reno.	Units		Bed/ Bath	Unit Size	Base Rent	
			Mix	Vac.			\$	\$/sf
			Floorplans					
<b>Santa Ana / Costa Mesa</b>								
<b>Broadstone Arden</b>	335	26%	7%	5	0 / 1.0	584	\$2,095	\$3.59
<i>Alliance</i>	5	2020	7%	1	0 / 1.0	744	\$2,405	\$3.23
1951 E Dyer Road			7%		0 / 1.0	864	\$2,856	\$3.31
Santa Ana			7%	2	0 / 2.0	1,009	\$3,345	\$3.32
92705			2%	4	1 / 1.0	1,000	\$3,410	\$3.41
			2%	5	1 / 1.0	907	\$2,825	\$3.11
			2%	2	1 / 1.0	956	\$2,880	\$3.01
			2%	5	1 / 1.0	689	\$2,381	\$3.46
			2%	5	1 / 1.0	745	\$2,496	\$3.35
			3%	2	1 / 1.0	770	\$2,575	\$3.34
			2%	2	1 / 1.0	782	\$2,551	\$3.26
			2%		1 / 2.0	1,215	\$3,056	\$2.52
			7%	5	2 / 2.0	1,089	\$3,205	\$2.94
			7%	5	2 / 2.0	1,087	\$3,115	\$2.87
			7%	3	2 / 2.0	1,109	\$3,250	\$2.93
			7%	5	2 / 2.0	1,077	\$3,200	\$2.97
			7%	2	2 / 2.0	1,184	\$3,375	\$2.85
			7%		2 / 2.0	1,189	\$3,595	\$3.02
			7%	4	2 / 2.0	1,239	\$3,400	\$2.74
			7%	3	2 / 2.0	1,284	\$3,355	\$2.61
			1%	5	3 / 2.0	1,454	\$3,915	\$2.69
			1%		3 / 2.0	1,956	\$4,631	\$2.37
<b>The Charlie</b>	228	13%	9%	5	0 / 1.0	523	\$1,840	\$3.52
<i>Alliance</i>	4	2019	2%	2	0 / 1.0	651	\$1,895	\$2.91
3630 Westminster Avenue			11%		1 / 1.0	681	\$1,995	\$2.93
Santa Ana			3%	1	1 / 1.0	684	\$2,015	\$2.95
92703			22%	6	1 / 1.0	696	\$2,055	\$2.95
			2%	5	1 / 1.0	844	\$2,230	\$2.64
			2%	3	1 / 1.0	860	\$2,300	\$2.67
			6%	5	2 / 2.0	997	\$2,455	\$2.46
			6%	5	2 / 2.0	1,041	\$2,530	\$2.43
			18%	8	2 / 2.0	1,052	\$2,670	\$2.54
			6%	4	2 / 2.0	1,066	\$2,680	\$2.51
			6%	2	2 / 2.0	1,079	\$2,765	\$2.56
			4%	5	3 / 2.0	1,236	\$3,230	\$2.61
			4%	5	3 / 2.0	1,239	\$3,305	\$2.67

APPENDIX A

SURVEY - APARTMENTS  
 SANTA ANA, COSTA MESA, ORANGE AND TUSTIN  
 MAY 2020

Project Name/ Manager/ Address	Units/ Elev.	Occ./ Year Built/ Reno.	Units		Bed/ Bath	Unit Size	Base Rent	
			Mix	Vac.			\$	\$/sf
			Floorplans					
<b>Nineteen01</b>	261	90%	3%	1	1 / 1.0	770	\$1,915	\$2.49
<i>Greenwood &amp; McKenzie</i>	5	2016	3%		1 / 1.0	773	<b>\$1,925</b>	\$2.49
1901 E 1st St			16%	2	1 / 1.0	774	\$1,905	\$2.46
Santa Ana			3%		1 / 1.0	795	<b>\$1,950</b>	\$2.45
92705			6%		1 / 1.0	826	<b>\$2,030</b>	\$2.46
			2%		1 / 1.0	848	\$2,090	\$2.46
			2%		1 / 1.0	860	\$2,110	\$2.45
			2%		1 / 1.0	864	\$2,125	\$2.46
			2%	1	1 / 1.0	890	\$2,200	\$2.47
			3%		1 / 1.0	948	\$2,455	\$2.59
			3%		1 / 1.0	967	\$2,385	\$2.47
			2%		1 / 1.0	974	\$2,397	\$2.46
			3%	1	2 / 2.0	982	\$2,500	\$2.55
			0%		2 / 2.0	1,034	\$2,665	\$2.58
			2%	1	2 / 2.0	1,058	\$2,550	\$2.41
			0%		2 / 2.0	1,081	\$2,375	\$2.20
			0%	1	2 / 2.0	1,085	\$2,775	\$2.56
			7%	1	2 / 2.0	1,122	\$2,580	\$2.30
			6%		2 / 2.0	1,380	\$3,050	\$2.21
			4%	1	2 / 2.0	1,142	\$2,655	\$2.32
			9%		2 / 2.0	1,156	\$2,659	\$2.30
			5%		2 / 2.0	1,180	\$2,714	\$2.30
			0%	1	2 / 2.0	1,193	\$2,750	\$2.31
			2%	1	2 / 2.0	1,195	\$2,705	\$2.26
			2%		2 / 2.0	1,260	\$2,885	\$2.29
			2%	1	2 / 2.0	1,265	\$2,895	\$2.29
			1%		2 / 2.0	1,284	\$2,959	\$2.30
			0%		2 / 2.0	1,391	\$3,068	\$2.21
			1%		2 / 2.0	1,476	\$3,120	\$2.11
			2%		2 / 2.0	1,639	\$3,468	\$2.12
			2%	1	2 / 2.0	1,712	\$3,415	\$1.99
			2%		2 / 2.5	1,760	\$3,663	\$2.08
			2%	1	3 / 2.0	1,510	\$3,465	\$2.29
			0%		3 / 2.0	1,632	\$3,456	\$2.12
			2%	1	3 / 2.5	2,020	\$3,865	\$1.91

## APPENDIX A

SURVEY - APARTMENTS  
SANTA ANA, COSTA MESA, ORANGE AND TUSTIN  
MAY 2020

Project Name/ Manager/ Address	Units/ Elev.	Occ./ Year Built/ Reno.	Floorplans					
			Units		Bed/ Bath	Unit Size	Base Rent	
			Mix	Vac.			\$	\$/sf
<b>Irvine / Tustin</b>								
<b>Amalfi</b>	542	95%	12%		0 / 1.0	584	\$2,035	\$3.48
<i>Irvine Company</i>	3	2014	5%		1 / 1.0	552	\$2,090	\$3.79
16000 Legacy Rd			4%	3	1 / 1.0	681	\$2,095	\$3.08
Tustin			3%	1	1 / 1.0	695	\$2,195	\$3.16
92782			5%	2	1 / 1.0	730	\$2,295	\$3.14
			12%		1 / 1.0	741	\$2,320	\$3.13
			8%	2	1 / 1.0	746	\$2,165	\$2.90
			12%	5	1 / 1.0	751	\$2,145	\$2.86
			7%	3	1 / 1.0	760	\$2,195	\$2.89
			5%		1 / 1.0	800	\$2,295	\$2.87
			3%		1 / 1.0	813	\$2,325	\$2.86
			4%		1 / 1.0	906	\$2,525	\$2.79
			2%	2	1 / 1.0	955	\$2,595	\$2.72
			2%		2 / 2.0	963	\$2,500	\$2.60
			9%	4	2 / 2.0	1,021	\$2,495	\$2.44
			8%	9	2 / 2.0	1,095	\$2,530	\$2.31
<b>Residences on Jamboree</b>	381	96%	1%	1	0 / 1.0	662	\$1,970	\$2.98
<i>UDR</i>	5	2017	17%	1	0 / 1.0	692	\$1,995	\$2.88
2801 Kelvin Ave			10%		1 / 1.0	687	\$2,144	\$3.12
Irvine			3%		1 / 1.0	698	\$2,214	\$3.17
92614			11%	1	1 / 1.0	701	\$2,124	\$3.03
<a href="https://www.udr.com/orange-county-apartments/irvine/the-1">https://www.udr.com/orange-county-apartments/irvine/the-1</a>			8%		1 / 1.0	757	\$2,224	\$2.94
			10%	3	1 / 1.0	762	\$2,014	\$2.64
			1%		1 / 1.0	782	\$2,319	\$2.97
			7%	1	2 / 2.0	1,063	\$2,724	\$2.56
			3%		2 / 2.0	1,108	\$2,789	\$2.52
			20%	2	2 / 2.0	1,147	\$2,979	\$2.60
			1%	2	2 / 2.0	1,165	\$2,699	\$2.32
			2%		2 / 2.0	1,284	\$3,099	\$2.41
			4%	3	3 / 2.0	1,426	\$3,499	\$2.45
			2%		3 / 2.0	1,503	\$3,599	\$2.39

APPENDIX A

SURVEY - APARTMENTS  
 SANTA ANA, COSTA MESA, ORANGE AND TUSTIN  
 MAY 2020

Project Name/ Manager/ Address	Units/ Elev.	Occ./ Year Built/ Reno.	Floorplans					Base Rent	
			Units		Bed/ Bath	Unit Size	\$	\$/sf	
			Mix	Vac.					
<b>Skyloft Apartments</b>	388	19%	8%		0 / 1.0	571	\$2,531	\$4.43	
<i>Legacy Partners</i>	5	2019	1%		1 / 1.0	690	\$2,628	\$3.81	
2700 Main St			4%		1 / 1.0	712	\$2,658	\$3.73	
Irvine			17%		1 / 1.0	733	\$2,698	\$3.68	
92614			10%		1 / 1.0	749	\$2,747	\$3.67	
			3%		1 / 1.0	762	\$2,797	\$3.67	
			1%		1 / 1.0	780	\$2,812	\$3.61	
			3%		1 / 1.0	781	\$2,813	\$3.60	
			3%		1 / 1.0	784	\$2,829	\$3.61	
			11%		1 / 1.0	836	\$2,555	\$3.06	
			1%		1 / 2.0	1,039	\$3,840	\$3.70	
			1%		2 / 2.0	1,019	\$3,083	\$3.03	
			2%		2 / 2.0	1,095	\$3,168	\$2.89	
			11%		2 / 2.0	1,132	\$3,363	\$2.97	
			1%		2 / 2.0	1,137	\$3,817	\$3.36	
			6%		2 / 2.0	1,162	\$3,623	\$3.12	
			5%		2 / 2.0	1,185	\$3,479	\$2.94	
			3%		2 / 2.0	1,188	\$3,499	\$2.95	
			1%		2 / 2.0	1,217	\$3,473	\$2.85	
			3%		2 / 2.0	1,222	\$3,513	\$2.87	
			2%		2 / 2.0	1,248	\$4,100	\$3.29	
			1%		2 / 2.0	1,296	\$4,212	\$3.25	
			2%		3 / 3.0	1,438	\$4,391	\$3.05	

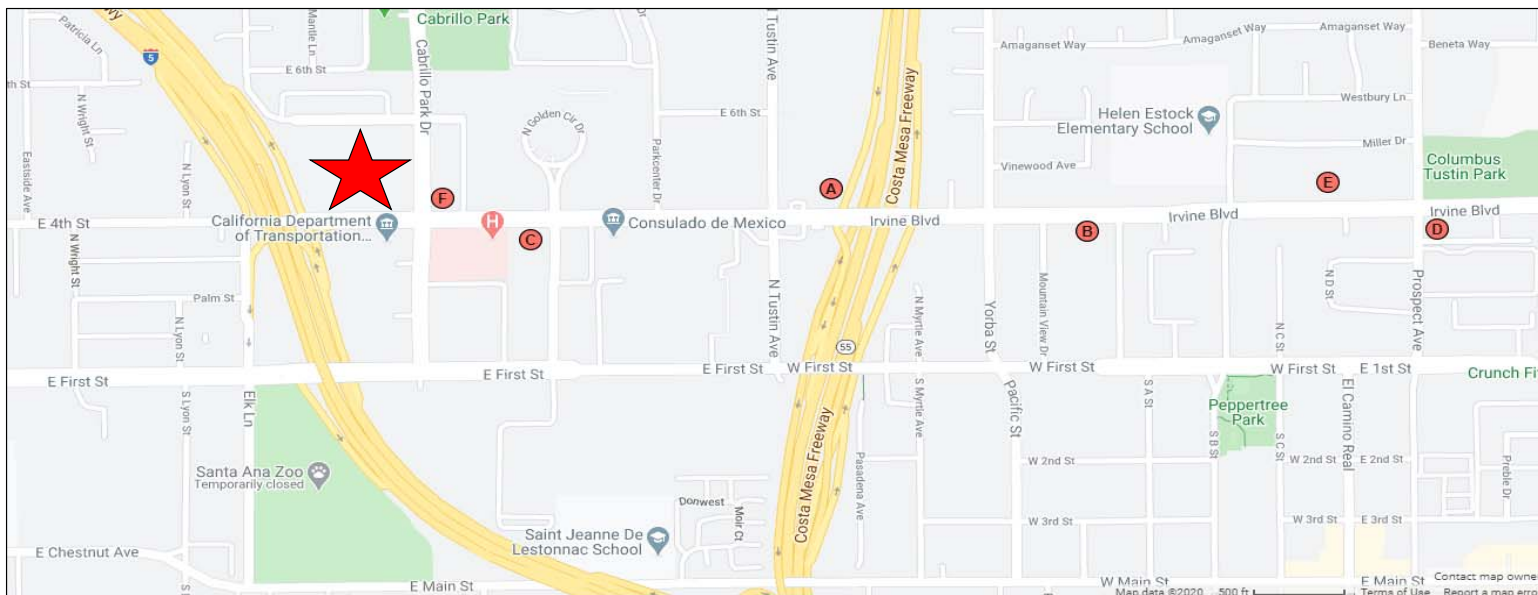
## APPENDIX A

SURVEY - APARTMENTS  
SANTA ANA, COSTA MESA, ORANGE AND TUSTIN  
MAY 2020

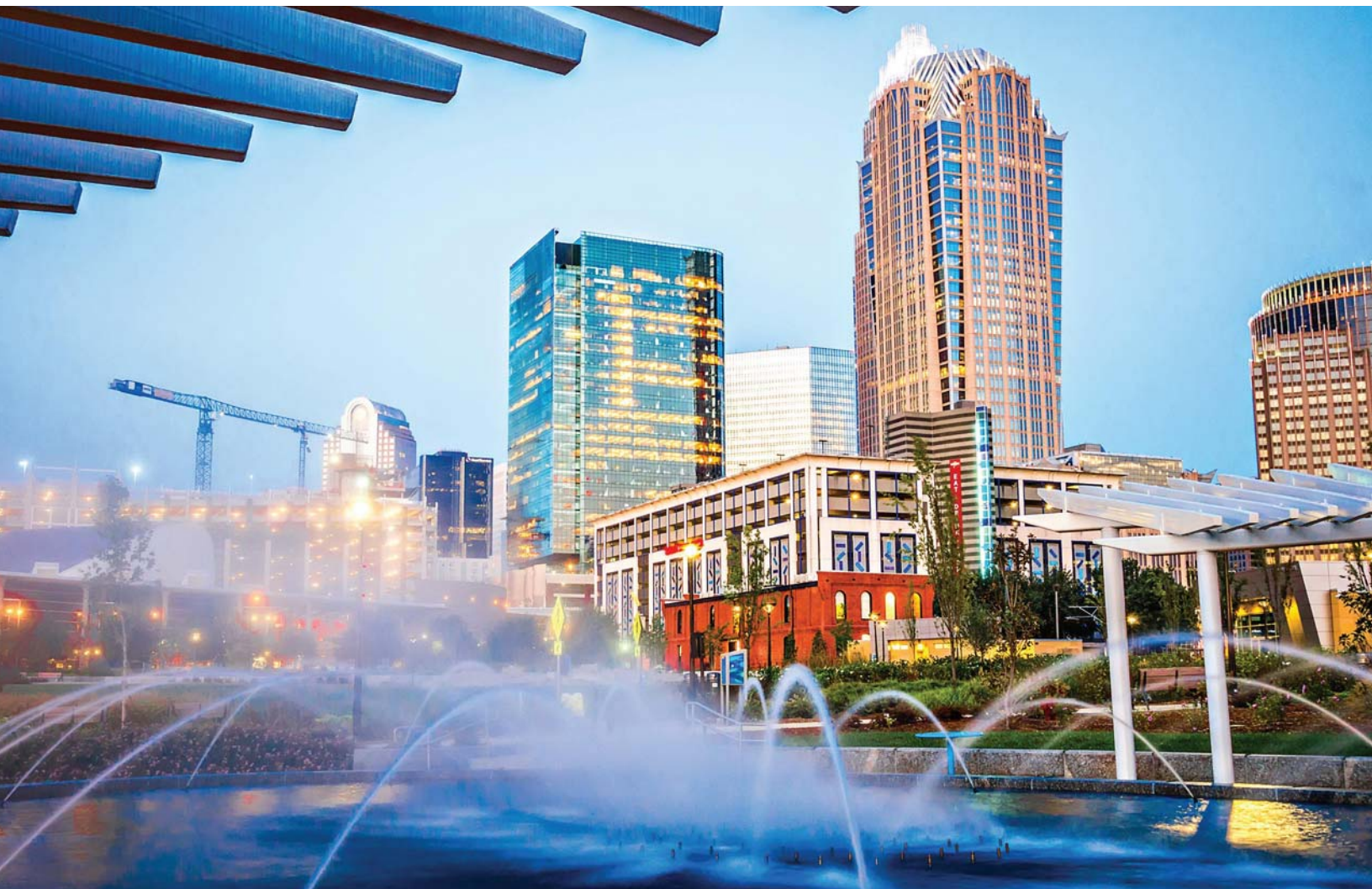
Project Name/ Manager/ Address	Units/ Elev.	Occ./ Year Built/ Reno.	Units		Bed/ Bath	Unit Size	Base Rent	
			Mix	Vac.			\$	\$/sf
			Floorplans					
<b>Anaheim / Orange</b>								
AMLI Uptown Orange	334	93%	3%	1	0 / 1.0	570	\$2,101	\$3.69
AMLI	4	2016	3%	2	1 / 1.0	626	\$2,241	\$3.58
385 S. Manchester Ave			4%	1	1 / 1.0	711	\$2,233	\$3.14
Orange			4%		1 / 1.0	716	\$2,416	\$3.37
92868			3%	1	1 / 1.0	745	\$2,484	\$3.33
			3%		1 / 1.0	748	\$2,485	\$3.32
			4%	4	1 / 1.0	802	\$2,267	\$2.83
			4%		1 / 1.0	816	\$2,300	\$2.82
			3%		1 / 1.0	823	\$2,320	\$2.82
			3%	4	1 / 1.0	829	\$2,216	\$2.67
			3%		1 / 1.0	837	\$2,238	\$2.67
			3%		1 / 1.0	840	\$2,238	\$2.66
			3%		1 / 1.0	857	\$2,275	\$2.65
			3%		1 / 1.0	862	\$2,278	\$2.64
			3%	1	2 / 2.0	978	\$2,717	\$2.78
			3%		2 / 2.0	993	\$2,760	\$2.78
			4%	1	2 / 2.0	1,002	\$3,214	\$3.21
			4%		2 / 2.0	1,010	\$3,220	\$3.19
			4%	1	2 / 2.0	1,047	\$2,883	\$2.75
			4%		2 / 2.0	1,049	\$2,626	\$2.50
			3%	1	2 / 2.0	1,050	\$2,890	\$2.75
			3%		2 / 2.0	1,054	\$2,900	\$2.75
			3%		2 / 2.0	1,063	\$3,186	\$3.00
			3%		2 / 2.0	1,122	\$3,299	\$2.94
			4%	3	2 / 2.0	1,131	\$2,874	\$2.54
			3%		2 / 2.0	1,133	\$2,890	\$2.55
			1%		2 / 2.0	1,142	\$2,900	\$2.54
			1%	1	2 / 2.0	1,147	\$2,988	\$2.61
			1%		2 / 2.0	1,175	\$3,050	\$2.60
			1%		2 / 2.0	1,211	\$3,556	\$2.94
			1%		2 / 2.0	1,236	\$3,304	\$2.67
			1%		3 / 2.0	1,404	\$3,655	\$2.60
			1%		3 / 2.0	1,431	\$3,710	\$2.59
<b>Eleven 10</b>	260	93%	21%	2	0 / 1.0	515	\$2,103	\$4.08
Piceme Residential	5	2018	5%		1 / 1.0	665	\$2,200	\$3.31
1110 W. Town and Country Rd			23%	0	1 / 1.0	737	\$2,387	\$3.24
Orange			20%		1 / 1.0	811	\$2,596	\$3.20
92868			7%	0	2 / 2.0	1,027	\$2,826	\$2.75
			2%		2 / 2.0	1,357	\$3,600	\$2.65
			3%	1	1 / 1.0	819	\$2,596	\$3.17
			19%	0	2 / 2.0	1,199	\$3,175	\$2.65

**APPENDIX B**  
**SURVEY - RETAIL LEASES**  
**ORANGE COUNTY AND LOCAL THREE-MILE TRADE AREA**  
**JANUARY 2017 THROUGH JULY 2020 - 3.5-YEARS**

Map Key	Shopping Center	City	Street Address	Building			Suite / Tenant	Lease			
				Year Built	Elev.	GLA		SF	Sign Date	Type	Rate Rent
<b>4th Street / Irvine Blvd Corridor - Grand Ave to Prospect Ave</b>											
A	Creskide Plaza	Santa Ana	2321 E. 4th St	2003	1s	8,818	Country Café (#A) Suite D	1,200	Dec-18	NNN	\$30
								1,500	Oct-17	NNN	\$30
								<b>Average:</b>			
B	17400 Irvine Blvd	Tustin	17400 Irvine Blvd	1968	1s	17,600	Medical (#M) Medical (#F)	1,100	Aug-20	FSG	\$29
								2,256	Aug-20	FSG	\$29
								<b>Average:</b>			
C	2000 E. 4th St	Santa Ana	2000 E. 4th St	1982	3s	34,080	Suite 350 Suite 110 Suite 202 Suite 304 Suite 320	1,663	Oct-19	FSG	\$26
								1,327	Apr-19	FSG	\$25
								1,470	Feb-19	FSG	\$25
								2,074	Nov-18	FSG	\$25
								2,270	Sep-18	FSG	\$23
								<b>Average:</b>			
D	17772 Irvine Blvd	Tustin	17772 Irvine Blvd	1973	2s	16,325	Suite 102-8 Suite 102-1	145	Sep-19	FSG	\$25
								245	Dec-19	FSG	\$25
								<b>Average:</b>			
E	17671 Irvine Blvd	Tustin	17671 Irvine Blvd	1972	2s	32,777	Suite 112	237	Sep-17	FSG	\$24
F	1901 E. 4th St	Santa Ana	1901 E. 4th St	1974	3s	39,699	Suite 312 Suite 350	1,622	Dec-19	FSG	\$23
								1,572	Aug-19	FSG	\$23
								<b>Average:</b>			
<b>Mixed-Use Analogs</b>											
<i># Apts</i>											
Pinnacle at MacArthur Place	Santa Ana	31 E. MacArthur Crescent Dr	2001	4s	253 MF	Suite 107 Suite 105 Suite 101 Suite 106B 9Round (#108) Braizen Sandwiches (#102)	1,714	Nov-19	NNN	\$30	
							941	Jul-19	NNN	\$30	
							1,143	Apr-19	NNN	\$30	
							869	Oct-18	NNN	\$30	
							1,428	May-18	NNN	\$30	
							1,126	Aug-17	NNN	\$30	
							<b>Average:</b>				
Pinnacle at Fullerton	Fullerton	229 E. Commonwealth Ave	2004	4s	192 MF	End Cap Suite A Heere Tea (#E)	875	May-19	NNN	\$33	
							2,526	May-19	NNN	\$30	
							1,888	Jul-18	NNN	\$30	
							<b>Average:</b>				



Source: CoStar



# Emerging Trends in Real Estate<sup>®</sup>

---

United States and Canada 2020



early innings.” But we can see the potential impact. Robotics will likely reduce the size of organizations and reduce the amount and type of real estate required. “Businesses will continue to get smaller due to technology and robotics. The most desirable talent in the future will be knowledge based and will need ‘omni-channels’ to work across an organization and drive alignment across functions.”

We need to better understand how people are using space to really make a difference. AI will allow continual learning of how we use space, resulting in increased use of space. In the words of one interviewee, “Place plus space drives human behavior. We know this can enhance people’s lives, improve productivity, improve mental states, improve health, and improve happiness.” In the future, “space will shift from reacting to predicting work patterns,” such as where to park based on your first meeting location of the day, or automatic desk reservations, both based on your digital calendar, or even voice-activated or sensor technology noting whether your meeting is over in the reserved conference room and now available to the next user.

Despite excitement surrounding integrated technology and interconnected building systems and big data, one interviewee pointed out that “there is a continued disconnect of focusing on the long-term possibilities before solving today’s realities.” People are still challenged “to get the technology that we already have to work—to start a video conference call, share content, or collaborate virtually,” but acknowledged that office environments that are responsive and predictive will inevitably be in our future as technology continues to be developed.

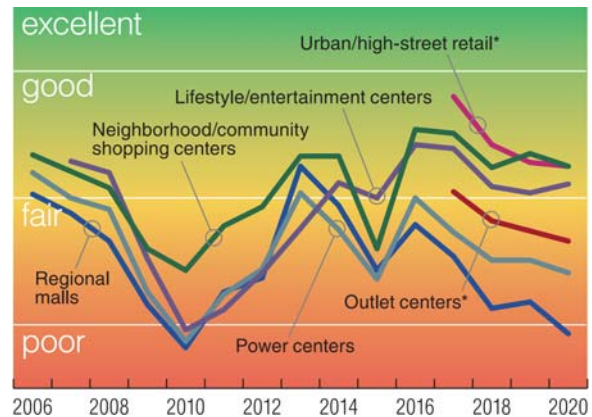
## Retail

“When you’re in the middle of a storm, you’re not quite sure when it’s going to end,” said one interviewee who oversees leasing for a large portfolio of regional shopping centers, continuing, “Turning on a dime is tough when undergoing the kind of shift this industry faces.”

The shifting retail picture is notably more complex than other property types. The integration of new concepts, formats, channels, and inventory management systems all cloud retail’s future, as does a broader economy-wide shift from goods to services. As a result, traditional shopping centers are transforming into “**consumer centers**” with a new mixture of uses. Another consumer need met: Kohl’s announced this summer that its stores will be Amazon return centers—and they will package and send back items for free.

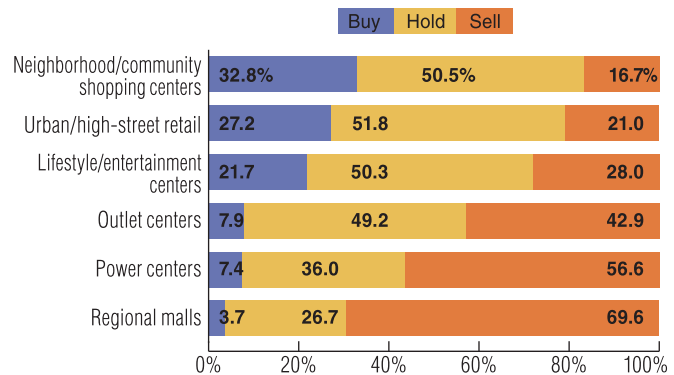
The era of “one size fits all” seems to be ending. Shopping centers now have the ability to become hyper-customized, due in

Exhibit 3-13 Retail Investment Prospect Trends



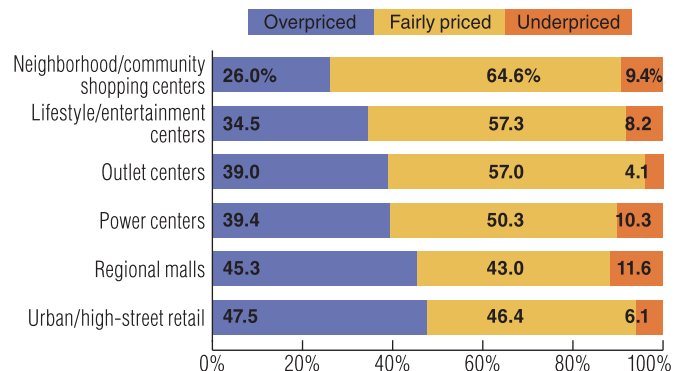
Source: *Emerging Trends in Real Estate* surveys.  
\*Fourth year in survey.

### Retail Buy/Hold/Sell Recommendations



Source: *Emerging Trends in Real Estate 2020* survey.  
Note: Based on U.S. respondents only.

### Opinion of Current Retail Pricing



Source: *Emerging Trends in Real Estate 2020* survey.  
Note: Based on U.S. respondents only.

part to advances in technology. These make it possible to tailor merchandising and engage with brands, uniquely targeting individual and local preferences.

### The Good News

There are bright spots within the sector: some interviewees are noticing stabilized rents and strong leasing activity across a wide spectrum. Some see retailers at an expansionary inflection point. As one respondent representing research services at a large commercial brokerage firm indicated, “Over the past several years, many retailers have directed their capital investments toward digital platforms. . . . Now, with more competitive omni-channel strategies, they could be poised to proceed with needed reinvestment in their physical footprint.”

Shopping center owners have also become more creative about filling spaces and taking opportunities to creatively remake centers into hybrid formats that incorporate new elements and experiences. As one interviewee involved in research services noted, “We’ve gotten through a ‘use evolution’ where landlords are no longer simply seeking to fill plain-white-vanilla boxes.” A commercial real estate investment adviser noted, “This was not the case just two to four years ago.” Said another involved retail market researcher, “This is creative destruction, or rationalization, where the death of one use brings about the rebirth of another.”

This rebirth responds to generational shifts in spending. As baby boomers edge closer to retirement, they are spending less on goods and directing more of their purchases toward medical needs, dining, and experiences. And millennials, as one real estate adviser noted, “also seem to be looking for less ‘stuff’ and more experiences.” On the other hand, generation X consumers have entered “full-on family mode,” spending more like past generations on children and homes. One expert indicated that “while this increase in spending has been delayed compared to previous generations, they are one of the stronger cohorts right now.”

### What’s Growing

Tenant turnover requires shopping center owners to learn about whole **new classes of tenants**. Never before have there been as much appetite and need to experiment with new uses to build traffic. Even the best-performing assets will require significant future capital investment to reach a stabilized mix with a broader array of uses.

A new crop of retailers have recognized the importance of physical stores and they are slowly building out a brick-and-mortar footprint. Within top-tier assets, **online brands** are expanding further into brick-and-mortar spaces while legacy brands waver. As one representative of a large REIT indicated, “They are coming in a meaningful way and expanding beyond their initial ‘high street locations.’ But, diversifying our mix from weaker stores into a new collection of brands takes time.” It was also noted that the process for deal-making has become longer and property net operating income (NOI) can lag in the interim.

New **experiential and entertainment uses**, centered on one-of-a-kind activities, such as art, amusements, or food, are continuing to push the boundaries of what is supportable in shopping centers. CoStar Group reports that the share of space devoted to restaurants, fitness centers, and entertainment has doubled over the past 10 years, while the share of apparel space continues to decline. “Ever-higher thresholds seem to be achievable, especially where there is a substantial influx from tourism,” said one respondent in real estate services.

Related to the trend toward experiential and entertainment uses is an ever-growing **food and beverage category**. There have been noticeable increases in food uses across retail venues, including food halls, which now seem ubiquitous in some areas. Not surprisingly, several respondents pointed to a potential glut in the food category (and more specifically food halls). However, there seems to be consensus that increases in food uses are likely. A trend toward healthier and more convenient food options also is evident as an alternative to conventional fast food.

A third and growing component within shopping centers today is the increasing presence of **fitness, health, and wellness uses**. They may take the form of gyms (both boutique and value), but also high-end workout equipment dealers. Related to health and wellness, medical offices and clinics also are rapidly expanding their presence.

A last area attracting widespread attention has been the introduction of **coworking and shared office space** within malls. Despite a flurry of fairly recent announcements over the past year or two, this phenomenon is still considered to be in its infancy and shows signs of strong growth potential. As one developer contact noted, “The idea is here to stay, although there could be a shakeout.” Shopping centers have built-in amenities to support them, including unused space, parking, complementary food uses, and perhaps even a gym or workout facility. “It’s a win/win,” said one mall operator.

### Promising Subsectors

Certain classes of assets continue to capture interest, most notably class A super-regional centers, grocery-anchored neighborhood centers, and urban high street locations.

As a real estate investment analyst noted, malls are a “mixed bag,” with the field essentially divided between top **class A malls** and “everything else.” The top assets tend to be better occupied, providing more favorable returns. “The ‘flight to quality’ continues where ‘must-have’ assets are becoming stronger.” These are the centers where almost all categories perform well, and not only luxury brands.

There also are opportunities in owning **daily needs–driven** neighborhood and community centers. These can be anchored by food-and-beverage or service uses, particularly in walkable neighborhoods and well-located infill projects. Many interviewees see strong prospects for future growth, especially with grocery anchors that are visibly making investments in their businesses and building an online platform. That platform can help keep centers relevant despite **online grocery sales**. While online grocery sales currently represent a very low share of total grocery sales in the United States (thought to be only 1 to 2 percent), one real estate services consultant stated, “This is an overlooked risk in the U.S.,” suggesting that we not be complacent about the potential impact. Said another retailer contact, “This is a thing. It’s the future. But, it’s almost impossible to make money at it at this point.”

Most believe that it still will be several years before a meaningful proportion of grocery sales move online, and physical stores will continue to play a role in distribution. Grocers in the United States do appear to be approaching it in a disciplined way, and the severe disruption that has occurred that has in other channels seems less likely to occur in grocery.

### The Clouds

As in previous years, retail real estate lies at the bottom in comparison with other property types, both in terms of investment and development prospects (exhibit 3-1). Retail real estate remains challenged as the sector continues through a transformation.

Most interviewees concur that reducing the number of physical stores is a “good thing” and alleviates the overabundance of retail space in the United States, which needs to be rationalized or absorbed by future population growth.

More closings and a “tough slog” appear to be on the horizon: according to data from Coresight Research as of June 2019, U.S. retailers have announced over 7,000 store closures this year, more than all of 2018 (which saw about 5,900 closings). The net effects are mitigated by store openings (approximately 3,000 so far in 2019, compared with just over 3,200 openings in 2018), but the result is a reduction in the number of physical stores.

### What’s Declining

Several conversations discussed an “expanding **void in the middle**,” noting that consumers are trading up to luxury goods and experiences, or down to value and off-price. Said one expert, “The middle is getting smaller. At the lower end is a value play, and higher end a luxury play. The gap between the ‘haves’ and ‘have nots’ is growing.”

Another important factor repeatedly mentioned was a lack of reinvestment by many retailers. Whether brought on by high debt loads after corporate buyouts or a general lack of capital, companies have been unable to reinvest in aging assets and maintain competitiveness.

The greatest disruption is in mall-based retail, particularly lower-tier class B and class C assets. Many agree that a good number of regional malls will disappear entirely, and that this is needed: one expert in commercial real estate services suggested that this is not as much a “decline of malls” as a “decline in **‘super-fluous’ malls**.” Still, suggestions that as many as three-fourths of shopping malls (roughly 900 of today’s approximately 1,200 malls) could close seem highly exaggerated.

A few experts suggest that **department store** mainstays are now all but obsolete. Their one-time role as a source for discovery and product research has been replaced by online browsing. Other interviewees still see relevance in the department store sector; however, it will be much smaller in size and number of units.

Similarly, inline **apparel** shops are weakening as other sectors strengthen. The exhibit on page 72 illustrates a notable shift away from apparel toward other uses: over a 10-year period, apparel’s share of gross leasable area (shown along with general retail, including department stores) has declined from 36 percent in 2007 to less than 29 percent in 2017.

These categories’ weakness may extend across price points. One retailer interviewee pointed out, “The overabundance of

space extends across channels and even discounters could experience 'rightsizing' and future consolidation."

Virtually every retailer will be required to adapt and change, resulting in both winners and losers. This fundamental shift needs to occur, although we cannot overlook the importance of physical stores in providing opportunities to discover and interact with retail brands.

### Technology and Flexibility

One universal theme among interviewees is the unrealized opportunity that landlords and tenants have to share information about their business, including the vast amount of **customer data** each is now able to collect. Observed one shopping center investment adviser, "Technology will be a differentiator that further reshapes retail in the future, especially in how 'big data' will help retailers understand their customers and their behavior." Using analytics to enhance customer experiences will define winners and losers in the coming years. Increasingly, retailers are relying on technology to anticipate consumer needs, fine-tune selections, and smooth pain points in the purchase process, thereby creating differentiating guest experiences.

Some have suggested that the digitally native online retailers have more to give here and, thus far, have been more transparent. There remains a perception that more traditional "legacy

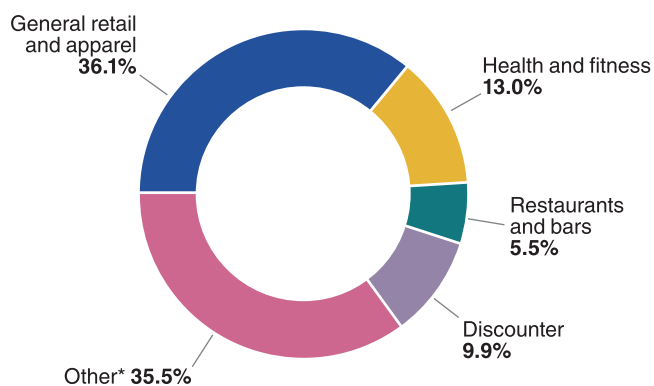
retailers" are more guarded about sharing insights. All believe that it is in our best interest to be more transparent and look for new mechanisms to better value physical stores and the role they play in a consumer's path to purchasing.

"Clearly, the old metrics don't work anymore," noted one interviewee working in leasing for a developer. "We need to find other ways to value the importance of physical stores." A retail insights researcher said, "The era of percentage rent is dead." There also is evidence that we may be seeing progress in terms of lease flexibility. As one interviewee from a real estate services firm noted, "Landlords seem much more willing to accept shorter and more flexible contracts now."

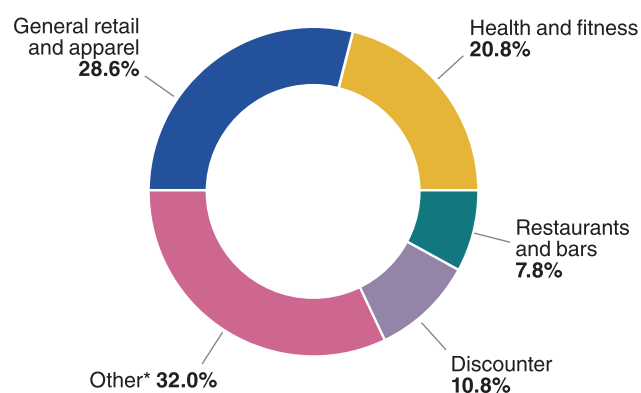
One specific future trend is unfolding in digital payments, rapidly moving toward an era of **frictionless retail**. As Amazon Go pioneered the experience of shopping without checkouts, it is considered to be only a matter of time before other retailers follow suit (and customers come to expect it). It will likely become the norm in a relatively short period of time, moving us closer to where, as one retailer noted, "Shoppers will be able to get what they want, where they want it, and how they want it, regardless of channel or format."

Exhibit 3-14 Share of Shopping Center Gross Leasable Area Leased by Tenant Type, 2007 versus 2017–3Q 2018

2007



2017–3Q 2018



Source: CoStar Realty Information Inc.

\*Includes entertainment as well as drug and other miscellaneous retail stores.

# EXHIBIT 14

1 - 274

# City of Santa Ana Review of Market & Fiscal Impact Analyses for Mixed- Use Development on 4<sup>th</sup> and Cabrillo

*Final Report*

October 22, 2020

SPR No. 2020-04  
1801 East Fourth Street  
Central Pointe Mixed-Use Development  
Exhibit 142-75 AECOM Peer Review

### **Economics General Limiting Conditions**

AECOM devoted the level of effort consistent with (i) the level of diligence ordinarily exercised by competent professionals practicing in the area under the same or similar circumstances, and (ii) consistent with the time and budget available for the Services to develop the Deliverables. The Deliverables are based on estimates, assumptions, information developed by AECOM from its independent research effort, general knowledge of the industry, and information provided by and consultations with Client and Client's representatives. No responsibility is assumed for inaccuracies in data provided by the Client, the Client's representatives, or any third-party data source used in preparing or presenting the Deliverables. AECOM assumes no duty to update the information contained in the Deliverables unless such additional services are separately retained pursuant to a written agreement signed by AECOM and Client.

AECOM's findings represent its professional judgment. Neither AECOM nor its parent corporations, nor their respective affiliates or subsidiaries ("AECOM Entities") make any warranty or guarantee, expressed or implied, with respect to any information or methods contained in or used to produce the Deliverables.

The Deliverables shall not to be used in conjunction with any public or private offering of securities, debt, equity, or other similar purpose where it may be relied upon to any degree by any person other than the Client. The Deliverables shall not be used for purposes other than those for which they were prepared or for which prior written consent has been obtained from AECOM.

Possession of the Deliverables does not carry with it any right of publication or the right to use the name of "AECOM" in any manner without the prior express written consent of AECOM. No party may reference AECOM with regard to any abstract, excerpt or summarization of the Deliverables without the prior written consent of AECOM. AECOM has served solely in the capacity of consultant and has not rendered any expert opinions in connection with the subject matter hereof. Any changes made to the Deliverables, or any use of the Deliverables not specifically identified in the Agreement between the Client and AECOM or otherwise expressly approved in writing by AECOM, shall be at the sole risk of the party making such changes or use.

The Deliverables were prepared solely for the use by the Client. No third party may rely on the Deliverables unless expressly authorized by AECOM in writing (including, without limitation, in the form of a formal reliance letter. Any third party expressly authorized by AECOM in writing to rely on the Deliverables may do so only on the Deliverable in its entirety and not on any abstract, excerpt or summary. Entitlement to rely upon the Deliverables is conditioned upon the entitled party accepting full responsibility for such use, strict compliance with this Agreement and not holding AECOM liable in any way for any impacts on the forecasts or the earnings resulting from changes in "external" factors such as changes in government policy, in the pricing of commodities and materials, changes in market conditions, price levels generally, competitive alternatives to the project, the behavior of consumers or competitors and changes in the Client's policies affecting the operation of their projects.

The Deliverables may include "forward-looking statements". These statements relate to AECOM's expectations, beliefs, intentions or strategies regarding the future. These statements may be identified by the use of words like "anticipate," "believe," "estimate," "expect," "intend," "may," "plan," "project," "will," "should," "seek," and similar expressions. The forward-looking statements reflect AECOM's views and assumptions with respect to future events as of the date of the Deliverables and are subject to future economic conditions, and other risks and uncertainties. Actual and future results and trends could differ materially from those set forth in such statements due to various factors, including, without limitation, those discussed in the Deliverables. These factors are beyond AECOM's ability to control or predict. Accordingly, AECOM makes no warranty or representation that any of the projected values or results contained in the Deliverables will actually occur or be achieved. The Deliverables are qualified in their entirety by, and should be considered in light of, these limitations, conditions and considerations.

Prepared for: City of Santa Ana

Prepared by: AECOM

AECOM  
401 West A Street  
Suite 120  
San Diego, CA 92101  
aecom.com

Copyright © 2020 by AECOM

All rights reserved. No part of this copyrighted work may be reproduced, distributed, or transmitted in any form or by any means without the prior written permission of AECOM.



## Table of Contents

1. Summary of Findings.....	5
2. Assessment.....	6
Appropriateness of Methodology.....	6
Multi-Family Market Analysis.....	6
Retail Market Analysis.....	6
Fiscal and Economic Impact Analysis.....	8
3. Appendix.....	12

## Figures

Figure 1: Retail Vacancy.....	7
-------------------------------	---

## Tables

Table 1: Mixed Use Projects.....	7
Table 2: Retail Leakage/Surplus.....	8
Table 3: Net Supportable Retail Demand Model.....	8
Table 4: Adjusted Fiscal Revenue Estimate for Sales Tax.....	9
Table 5: Adjusted Fiscal Expenditure Estimate.....	10
Table 6: Adjusted Fiscal Revenue and Expenditure Estimates.....	10
Table 7: 25-Year Recurring Adjusted Fiscal Impact.....	11
Table 8: Retail Demand Model for the Project Site.....	12

# 1. Summary of Findings

At the request of the City of Santa Ana (“City”), AECOM has conducted an independent review of a report (“Report”) prepared for Arnel Development Co. by The Concord Group (“TCG”) titled *Market & Fiscal Impact Analyses for a Mixed-Use Development in Santa Ana, CA (4th & Cabrillo Park Dr)*.

Arnel Development Co. (the “Developer”) has proposed a mixed-use project (“Project”) for a site in the City with 644 apartment units and 15,200 square feet of commercial space. The Project, located at 4<sup>th</sup> & Cabrillo Park Drive, is to be located in the MEMU (Metro East Mixed-Use) Overlay District in the City of Santa Ana. The Developer engaged TCG (in association with a second firm RSG) to “conduct market and fiscal feasibility analyses for the project” in order to “identify the highest and best use for the site” and “demonstrate the financial viability of the development.”

AECOM’s findings are summarized below.

1. The Report presents strong evidence for the market feasibility and fiscal impacts of the Project, but it does not clearly establish the highest and best use or financial viability of the Project.
2. The Report’s conclusions about support for multi-family residential Market are substantiated by market data. The rents represent the higher end of the potential range but are reasonable based on location, proposed amenities, and unit mix.
3. The Report’s retail market analysis concludes that 15,200 retail square feet is supportable in the market based on an assessment of three comparable mixed-use developments. AECOM supplemented this analysis and found further evidence to validate the potential range of supportable retail for the Project. However, neither the Report nor AECOM’s analysis can fully forecast whether long-term retail demand patterns may fundamentally change as a result of the pandemic.
4. The estimates for potential property tax, utility users’ tax, and business taxes apply commonly accepted methodology, and the estimates are validated in the Report’s analysis.
5. In estimating potential sales taxes, the Report assumes different retail capture rates and retail sales yields than used in comparable studies. However, an alternate analysis prepared by AECOM using the adjusted input assumptions validates the Report’s estimates, which are slightly lower—and therefore more defensibly conservative—than those calculated in the alternative.<sup>1</sup>
6. The Report’s estimate of City fiscal expenditures that would result from the Project appears low. The Report estimates that on a pro-rata basis, the fiscal expenditure for each member of the service population is approximately \$250, while AECOM in a separate report recently estimated such costs at \$480 per service population member. Applying the AECOM pro-rata measure results in an estimated 104 percent increase of fiscal expenditures resulting from the Project.
7. Net fiscal revenue is the difference between estimated fiscal revenues and fiscal expenditures. Applying AECOM’s adjusted input assumptions for calculating fiscal revenues and fiscal expenditures results in a net present value net fiscal revenue estimate of \$10.3 million, which represents a decrease of \$5.7 million from the \$16 million estimated provided by the TCG Report.
8. The Report’s estimate of the Project’s economic impacts on employment in the Region use IMPLAN input-output modelling for both the construction and stabilized buildout stages of the project. AECOM reconstructed the model and found no significant deviations in results.

---

<sup>1</sup> While not material to overall sale tax estimate, the TCG Report, in Tables 2, 6, and 7 show an inconsistency that should be explained if intended or corrected if in error. This inconsistency is discussed further in the analysis below.

## 2. Assessment

### Appropriateness of Methodology

In the preamble, the Report states as its goal to “identify the **highest and best use** of the project under current MEMU zoning and demonstrate **financial viability** of the development.”

Identification of highest and best use typically involves comparison of multiple potential land uses using proforma analysis to estimate potential project returns or residual land value. Determination of financial viability may also rely on proforma analysis to estimate Net Operating Income (NOI) and development costs. While the Report features multiple exhibits that demonstrate key inputs and parameters that could be incorporated into proforma analysis, no such additional analysis is conducted to test for highest best use and financial viability.

### Multi-Family Market Analysis

The Multi-Family Residential (MFR) market analysis clearly demonstrates potential achievable rents for the units proposed in the project. The Report’s assumptions and data are consistent with previous analysis conducted by AECOM of the residential market, and the Report’s conclusions are supported by the analysis.

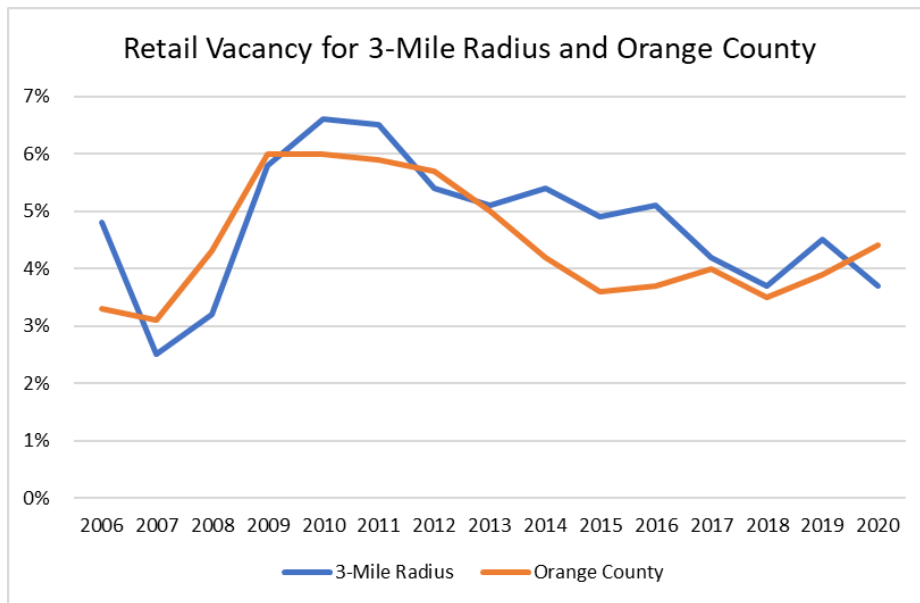
The rents, absorption rates, vacancies, and unit mixes presented in the comparative analysis are broadly representative of the competitive market area. While the proposed rents represent the upper range for the market areas examined, they may be justifiable by the desirable location and the quality of proposed amenities. The Project unit mix, which emphasizes 1-BR units (51 percent) and 2-BR units (39 percent), appears to be optimized to take advantage of market area trends, which indicate that smaller units command higher rents (on a square-foot-basis) and achieve lower vacancy rates than 3-BR units.

### Retail Market Analysis

The City is particularly interested in the potential for the Project to include retail space to support the mixed-use nature of the MEMU land use designation. The proposed Project currently contains 15,200 square feet of retail space, and the Report justifies this quantity through arguments regarding Project location, general retail market trends, and comparison with other established mixed-use projects. AECOM has supplemented this analysis with retail leakage/surplus analysis and a retail demand model and concurs that under normal market conditions, 15,200 square feet is supportable. However, as the long-term market impact of COVID-19 on retail performance is not known, caution regarding retail expansion is warranted.

The Report features a comparison with three existing mixed-use projects in Orange County that highlight the potential difficulty the Project may face attracting and retaining retail tenants. Two of these comparison projects, which have a similar walkability score as the Project, show vacancy rates of 70 percent and 56 percent. However, such rates are not typical for retail in Orange County, as indicated by Figure 1, which shows retail vacancies fluctuating between 2.5 percent and 6.5 percent between 2006 and 2020 in Orange County and within the 3-Mile Radius surrounding the Project. While the comparison projects illustrate the potential difficulties of sustaining retail tenants in mixed-use projects, the general retail market in Orange County has remained stable in the recent past.

**Figure 1: Retail Vacancy**



Source: Costar

There are three other mixed-use residential and retail projects in the development pipeline with program retail ranging from 6,000 to 24,290 square feet contributing 1.4 percent to 3.5 percent of total Gross Building Area (GBA). The Project’s 15,200 square feet of retail space represents approximately 2.6 percent of GBA, which falls within the range of both pipeline projects and similar projects under development within a half mile of the Project’s site, as shown in Table 1.

**Table 1: Mixed Use Projects**

Comparison of Mixed-Use Projects Under Development within Half-Mile of the Project					
Project Name	Project Address	Dwelling Units	Total GBA (SF)	Retail Space (SF)	% Retail
Madison	200 N Cabrillo Park Dr.	260	186,000	6,500	3.5%
AMG First Point	2112 & 2116 E. First St.	552	700,000	10,000	1.4%
Elan	1600 E. First St.	603	650,000	20,000	3.1%
Project	4th and Cabrillo	644	576,000	15,200	2.6%

Source: Costar, City of Santa Ana, AECOM

Retail leakage/surplus analysis offers another perspective on retail potential. Leakage/surplus analysis compares estimated potential retail spending with estimated actual retail spending to determine whether there is a variance. A surplus variance, where estimated retail spending exceeds estimated demand, indicates the area is drawing retail spending from outside its boundaries, whereas a deficit variance suggests retail “leakage” where residents are leaving the area for retail spending. Leakage can indicate an undersupply of retail space and a potential opportunity for retail development (although not always: if substantial retail supply exists just outside of the boundaries of an area showing leakage, then new supply within the area risks oversupplying the market and diluting sales).

AECOM conducted a retail leakage/surplus analysis for both the City of Santa Ana and the 2-Mile Radius<sup>2</sup> around the site and found that both geographies capture a significant surplus of retail spending. While the surplus is a net benefit to the City, which benefits from the resulting sales taxes, it also suggests the area is already well supplied and may not have capacity to absorb much more. While the new on-site residential population will help absorb some of this demand, the proposed retail also needs to be unique and differentiated enough to continue to draw shoppers from outside the area to avoid diluting the performance of existing retail supply. Table 2 shows that the 2-Mile Radius has a

<sup>2</sup> AECOM uses standard geographies for retail demand assessment, typically a half mile and 2-mile radius around the site that represent the immediate opportunities for pedestrian traffic and a short car ride respectively.

retail surplus of over \$640 million in sales, while the City of Santa Ana has a surplus of approximately \$1.2 billion in sales.

**Table 2: Retail Leakage/Surplus**

<b>2-Mile Radius Retail Leakage/Surplus Analysis</b>					
	<b>Demand</b>	<b>Supply</b>	<b>Retail Gap</b>	<b>Leakage/Surplus</b>	<b>Number of</b>
	<b>(Retail Potential)</b>	<b>(Retail Sales)</b>		<b>Factor</b>	<b>Businesses</b>
<b>Retail Trade</b>	\$1,124,811,711	\$1,655,118,799	<b>-\$530,307,088</b>	<b>-19.1</b>	895
<b>Food &amp; Drink</b>	\$124,997,520	\$235,536,446	<b>-\$110,538,926</b>	<b>-30.7</b>	395
<b>Total</b>	\$1,249,809,231	\$1,890,655,245	<b>-\$640,846,014</b>	<b>-20.4</b>	1,290

<b>City of Santa Ana Retail Leakage/Surplus Analysis</b>					
	<b>Demand</b>	<b>Supply</b>	<b>Retail Gap</b>	<b>Leakage/Surplus</b>	<b>Number of</b>
	<b>(Retail Potential)</b>	<b>(Retail Sales)</b>		<b>Factor</b>	<b>Businesses</b>
<b>Retail Trade</b>	\$2,311,832,197	\$3,452,949,815	<b>-\$1,141,117,618</b>	<b>-19.8</b>	1,606
<b>Food &amp; Drink</b>	\$255,926,740	\$405,314,351	<b>-\$149,387,611</b>	<b>-22.6</b>	646
<b>Total</b>	\$2,567,758,937	\$3,858,264,166	<b>-\$1,290,505,229</b>	<b>-20.1</b>	2,252

*Source: ESRI, AECOM*

As a final test of supportable retail supply, AECOM prepared a retail demand model that quantifies supportable retail based on a region's demographics, socio-economic trends, and the current development pipeline. The model assumes capture rates for residents and employees based on their proximity to the site and data on retail spending patterns. Based on current demographics and projects in the development pipeline, the model estimates the Project could support between 10,000 and 21,000 square feet of retail space. This indicates that the 15,200 square feet currently proposed falls well within the range of supportable retail at the site. The calculation of net supportable square feet, as shown in Table 3, is based on an estimate of total supportable square feet less the approximately 40,890 square feet of retail space in several mixed-use projects currently proposed or under construction within a half mile of the Project's site. An extended table showing the model's assumptions is found in Appendix A.

**Table 3: Net Supportable Retail Demand Model**

<b>Retail Demand Model Net Supportable Retail at 4th and Cabrillo</b>			
	<b>Total Supportable</b>	<b>Current Pipeline</b>	<b>Net Supportable</b>
<b>High Scenario (\$350/SF)</b>	61,500	40,890	<b>21,000</b>
<b>Low Scenario (\$425/SF)</b>	50,600	40,890	<b>10,000</b>

*Source: ESRI, BLS, LEHD, Costar, California DOF, ICSC, AECOM*

These findings support TCG's analysis in the Report and offer validation that the proposed 15,200 square feet of retail could be supported under normal market conditions.

## Fiscal and Economic Impact Analysis

The Report estimates fiscal impacts on City's General Fund that may result from the Project. Fiscal impacts are comprised of fiscal revenues and fiscal expenditures. Fiscal revenues considered by the Report include Property Tax, Property Tax in-Lieu of VLF, Sales Tax (Direct and Indirect), Utility User Tax, and Business Tax, while fiscal expenditures include Police, Fire, Parks/Recreation/Community Services, Finance & Management Services, Planning & Building Agency, Personnel Services, and the Clerk of the Council.

### Property Tax

Estimated Property Tax revenues are based on an estimate of assessed value of the Development at full buildout. This approach to property valuation is widely accepted and suitable for the Project in its current stage of development. The estimate of Property Tax in-lieu of VLF uses a proportional approach, in which estimated Project assessed value is compared to Citywide assessed value, and the proportional increment of new value is applied to the previous year's Property Tax in-lieu of VLF payment to estimate the new incremental tax revenue. This is a common and generally accepted estimation methodology.

**Sales Tax**

Estimates for indirect Sales Tax rely on several assumptions regarding household/employee spending habits and the City’s capture of this spending. The Report estimates a City capture rate of 60 percent of taxable spending for new households. Capture rates in comparable studies from AECOM (2018), Economic and Planning Systems (2016) and Keyser Marston Associates (2018) show a range from 25 percent to 50 percent with greater capture rates for developments near the commercial center of larger cities. Precedents from other studies suggest that the 60 percent capture rate for new households may be high considering the Project’s central in Orange County with numerous shopping centers in neighboring jurisdictions. A more conservative and defensible capture rate would be between 30 percent and 40 percent.

The estimate of taxable sales for households is within the range of several data sources. The Bureau of Labor Services Consumption Survey for the Los Angeles Metro Area estimates taxable sales of approximately \$22,000 per household in the region, while ESRI estimates approximately \$18,000 for the City. Because of the small average size of the households projected to occupy the principally 1-BR and 2-BR dwelling units, the Report’s approximate annual household spending of \$17,800 is a reasonable estimate.

For the business-derived sales tax, the Report assumes a rate of \$250 per square foot of retail space to estimate total sales. According to an eMarketer survey of retail locations in Southern California, sales per square foot averaged \$436 in 2018 with a median of \$322. Consequently, assuming a higher sales tax rate may be defensible.

The Report shows inconsistency in the sales tax estimates as indicated in Table 2 and Tables 6 and 7 of the Report. Table 2 in the Report, which shows a cashflow analysis representing the 25-year net new recurring fiscal impact projections of all estimated revenue streams and expenditures, lists the base rate sales tax at buildout at \$90,244 and the Measure X sales tax at \$135,366. These figures are consistent with the concluding text on page 42 of the Report that summarizes the fiscal impacts of sales tax. However, Tables 6 and 7 in the Report and the accompanying text show a combined \$103,700 for base rate sales tax at buildout and \$155,550 for Measure X sales tax at buildout. These measures are approximately 15 percent higher than the measures shown in the cashflow analysis in Table 2 of Report on which the net fiscal revenue calculations are based. In a final version of the Report, TCG should explain this discrepancy if intended or correct it if an error.

In order to test the impacts of observations above about different input assumptions for calculating fiscal revenues and fiscal expenditures, AECOM prepared an alternate estimate that assumes \$350/square foot in retail sales and a capture rate of 40 percent. In addition, to explore whether the data discrepancy discussed above might also have a meaningful impact, AECOM prepared an alternate version of the Report’s estimate: as shown in Table 4 below, “Report” represents TCG’s base estimate, which uses the cashflow shown in the Report’s Table 2. The “Report Alternative” estimate is based on the sales tax measures shown in the Report’s Tables 6 and 7. The results of these alternate calculations show the Report’s original estimate to be the lowest and most conservative, with a net present sales tax value (NPV at 4% discount rate) of approximately \$3.6 million. The AECOM alternative, with a higher sales yield per square foot but lower capture rate, is higher at approximately \$4.1 million. Finally, the Report Alternative is highest at approximately \$4.3 million. From this, it may be concluded that the Report’s original finding is defensible but that higher Project fiscal revenues may be achievable.

**Table 4: Adjusted Fiscal Revenue Estimate for Sales Tax**

Fiscal Impact of Sales Tax Assumptions				
	Sales Tax Base Rate <sup>1</sup>	Sales Tax Measure X <sup>1</sup>	Total Sales Tax <sup>1</sup>	25-Year Recurring Sales Tax (NPV at 4% Discount)
<b>Report<sup>2</sup></b>	\$90,244	\$135,366	\$225,610	\$3,640,360
<b>Report Alternative<sup>3</sup></b>	\$103,700	\$155,550	\$259,250	\$4,298,055
<b>AECOM</b>	\$99,584	\$149,376	\$248,960	\$4,127,459

(1) Annual revenues at first year of buildout of the Project  
 (2) Cash Flow Analysis from Table 2 in the Report  
 (3) Derived from Tables 6 and 7, based on the methodology described in the Report  
 (4) Assumes 40% capture rate for Project residents and \$350 per square foot for Project retail space  
 Source: TCG, RSG, AECOM

**Utility User, Franchise and Business Taxes**

The Report estimates Utility Users Taxes based on household data for phone, electricity, gas, and water expenditures for Project residents and Energy Information Association (EIA) estimates of utility expenditures for retail properties for the Project’s retail space.

Business Tax estimates are based on annual sales of the retail future retail tenants and business activities of the property management company. These are acceptable methodologies, and the predictions are in line with assumptions made in comparable studies.

**Fiscal Expenditures**

The Report applies a standard pro rata fiscal expenditure for the service population of the Project (which is derived from commuting patterns of the City’s residents and workforce. Based on estimated demand for City services from people living and working in Santa Ana (with demand adjusted to reflect time spent in the City as it varies between full-time residents and in-commuters), the Report estimates a service population of 1,399 persons for the Project. This methodology is a standard practice and widely accepted for general planning purposes.

The Report estimates that City expenditures for the service population would result in an increase of approximately \$354,000 for the first full year of buildout, or approximately \$253 per person. This estimate is based on the City budget for Fiscal Year 2019-2020 and considers whether expenditures are variable versus fixed costs. The estimate excludes costs such as the City Manager’s office and City Attorney’s Office but scales up services such as the Police and Fire Departments. AECOM recently conducted a series of fiscal analyses for the City that adopted a similar approach that combined budgetary and demographic analysis with interviews with City staff. The most recent report (March 2020) estimated a pro-rata expenditure of \$487 per member of the service population. The AECOM estimate represents an increase of \$234 over the Report’s estimate, a variance that if applied to the overall estimate has a substantial impact on the Gross Expenditures and Net New Revenues from the Project. Using the same assumptions as the Report in calculating the rolling 25-year impact (Net Present Value at a discount rate of 4 percent), AECOM estimates fiscal expenditures at approximately double of that estimated by the Report. The results of these estimates are shown in Table 5.

**Table 5: Adjusted Fiscal Expenditure Estimate**

Pro Rata City Expenditure Estimates				
	Service Population	Pro Rata Share	Total Annual Expenditures at Buildout	25 Year Net Recurring (NPV at 4%)
<b>Report</b>	1,399	\$253	\$353,986	\$7,026,724
<b>AECOM (2020)</b>	1,399	\$487	\$681,313	\$14,354,016

*Source: US Census LEHD, ESRI, Santa Ana 2019-20 Adopted Budget, AECOM*

This adjusted fiscal expenditure estimated carries over to the estimate of Net New Revenue. As shown in Table 6, estimated adjustments to annual fiscal revenues (sales tax) and expenditures result in net new fiscal revenues of approximately \$540,000 compared to \$890,000 for the first year of buildout out. As shown in Table 7, estimated adjustments to fiscal revenues and fiscal expenditures result in a net present value estimate of \$10.3 million, compared with the Report’s estimate of \$16 million.

**Table 6: Adjusted Fiscal Revenue and Expenditure Estimates**

Adjusted Annual Fiscal Impacts at Project Buildout			
	Sales Tax at First Year Buildout	Fiscal Expenditures at First Year Buildout	Net New Fiscal Revenues at First Year Buildout
<b>Report<sup>1</sup></b>	\$225,610	-\$353,986	\$891,096
<b>AECOM</b>	\$248,960	-\$681,313	\$540,418

(1) Assumes Sales Tax cash flow analysis from Table 2 in the Report

*Source: TCG, RSG, AECOM*

**Table 7: 25-Year Recurring Adjusted Fiscal Impact**

<b>25-Year Recurring Net New Fiscal Impacts (NPV at 4% discount rate)</b>			
	<b>25 year Recurring Fiscal Revenues</b>	<b>25 year Recurring Fiscal Expenditures</b>	<b>25 year Recurring Net New Impact</b>
<b>Report<sup>1</sup></b>	\$23,109,060	\$7,026,724	\$16,082,335
<b>AECOM</b>	\$24,679,077	\$14,354,016	\$10,325,061
(1) Assumes Sales Tax cash flow analysis from Table 2 in the Report			
<i>Source: TCG, RSG, AECOM</i>			

**Economic Impacts**

The Report only considers the impacts on employment for the “Region,” which is not specified (but is likely to be Orange County). The Report derives an estimate of construction phase jobs from construction costs. The estimate of permanent jobs is derived from rate assumptions that associate employment with retail square footage and dwelling units. The analysis uses IMPLAN software that draws on data from several local, state and federal sources, including the Bureau of Economic Analysis (BEA), the Bureau of Labor Statistics (BLS), and the California Department of Finance. This software package is used widely for estimating economic impacts across a wide array of industries and economic settings. To test the estimated economic impacts shown in the Report, AECOM conducted a parallel IMPLAN input/output analysis using the Report’s inputs for Project construction costs and full-time positions. The outputs of AECOM’s model were close to those of the Report and validate the Report’s employment estimates.



# 3. Appendix

**Table 8: Retail Demand Model for the Project Site**

Estimated 4th and Cabrillo Capture of Household Retail Expenditures						
	1/2 Mile Radius		2 Mile Radius <sup>1</sup>		Total	
	Current	Buildout <sup>2</sup>	Current	Buildout <sup>2</sup>	Current	Buildout <sup>2</sup>
<b>Households</b>	2,216	4,271	35,204	35,746	37,420	40,017
On-Site <sup>3</sup>	0	612	0	0	0	612
Site Capture(%)	7.5%	7.5%	0%	0%	0%	0%
Off-Site	2,216	3,659	35,204	35,746	35,204	39,405
Site-Capture(%)	5.0%	5.0%	2.5%	2.5%	2.5%	2.5%
Median HH Income	\$60,500	\$60,500	\$60,500	\$60,500	\$60,500	\$60,500
HH Retail Expenditures <sup>4</sup>	\$15,125	\$15,125	\$15,125	\$15,125	\$15,125	\$15,125
<u>Estimated Household Sales Capture</u>	<u>\$1,675,850</u>	<u>\$3,461,281</u>	<u>\$13,045,282</u>	<u>\$13,246,127</u>	<u>\$13,045,282</u>	<u>\$16,707,408</u>
<b>Employees</b>	5,900	5,900	54,700	55,272	60,600	61,172
On-site	48	48	0	0	48	48
Annual Expenditures <sup>5</sup>	\$4,000	\$4,000	\$4,000	\$4,000	\$4,000	\$4,000
Site Capture (%)	5.0%	5.0%	0%	0%	0%	0%
Off-site	5,852	5,852	54,700	55,272	60,552	61,124
Annual Expenditures <sup>5</sup>	\$4,000	\$4,000	\$4,000	\$4,000	\$4,000	\$4,000
Site Capture (%)	4%	4%	2%	2%	2%	2%
<u>Estimated Business Sales Capture</u>	<u>\$852,288</u>	<u>\$852,288</u>	<u>\$3,938,400</u>	<u>\$3,979,606</u>	<u>\$4,790,688</u>	<u>\$4,831,894</u>
<b>Total Estimated Retail Capture</b>	<b>\$2,528,138</b>	<b>\$4,313,569</b>	<b>\$16,983,682</b>	<b>\$17,225,733</b>	<b>\$19,511,820</b>	<b>\$21,539,302</b>
<b>Supportable Retail SF (\$350/SF)<sup>6</sup></b>	<b>7,223</b>	<b>12,324</b>	<b>48,525</b>	<b>49,216</b>	<b>55,748</b>	<b>61,541</b>
<b>Supportable Retail SF (\$425/SF)<sup>6</sup></b>	<b>5,949</b>	<b>10,150</b>	<b>39,962</b>	<b>40,531</b>	<b>45,910</b>	<b>50,681</b>

(1) 2 Mile Radius is exclusive of 1/2 Mile Radius to avoid double counting  
(2) Assumes stable occupancy of all known current development pipeline  
(3) Assumes 95% Occupancy of the Project  
(4) BLS assumes 20%-30% of median income is spent on all retail categories, site capture adjusted for retail type  
(5) Based on ICSC data for average workday spending for office/retail workers, excluding transportation, grocery, and warehouse expenditures  
(6) Gross supportable retail before adjustment for retail development in the current pipeline

Source: ESRI, BLS, LEHD, Costar, California DOF, ICSC, AECOM

# EXHIBIT 15

1 - 287



**MEMORANDUM**

**To:** City of Santa Ana  
**From:** THE CONCORD GROUP  
**Date:** October 22, 2020  
**Re:** **Viability of a Grocery Store and Market Optimal Scale of Retail for the 4<sup>th</sup> and Cabrillo Project in Santa Ana, CA**

In August 2020, The Concord Group (“TCG”) completed a highest and best use analysis for the 4<sup>th</sup> and Cabrillo project in Santa Ana. It was TCG’s conclusion that the current plan set forth by the developer, which includes 644 apartments and 15,200 square feet of retail, is the highest and best use for the property.

Per preliminary feedback from the Planning Commission, we understand the City would like further explanation with regards to two key conclusions in the analysis:

1. A grocery store is not supportable on site;
2. The +/- 15,000 square feet of retail planned is the maximum marketable retail square footage that the project can support.

Grocery Store

A grocery store is not viable in the project. Grocery stores require: (1) a high degree of marketing visibility; (2) high density of nearby rooftops with strong incomes; and (3) and convenient accessibility.

1. With regards to point 1, the project possesses attractive visibility along 4<sup>th</sup> Street, with up to 30,000 cars passing by the site daily. However, with regards to points 2 and 3, the project fails.
2. The density of rooftops and associated incomes is insufficient to attract a grocery tenant. Within a one-mile radius of the project, there are only 9,800 households, with incomes well below the County median.
3. Only in the most urban settings (ie. downtown Los Angeles, Santa Monica), will grocery operators consider structured parking for their shoppers. Grocery shoppers seek “easy in / easy out” accessibility. The large amount of surface parking required for a grocery store would render the mixed-use character of the project financially infeasible.

Scale of Retail

The current scale of retail planned for the project is the maximum that can be supported on the site. There are several marketing concerns limiting the market viability of more retail on site:

1. There is limited demand for new retail in the site’s trade area. Over the last ten years, only 100,000 square feet of retail has been added, with no improvements to retail occupancy during the timeframe.
2. Secondly, successful, large-scale commercial shopping destinations require anchor tenancy – typically a grocery – which is not viable on site. Anchor tenants are the “draw” that attract consumers to the smaller, in-line tenant spaces.
3. Lastly, while mixed-use retail and residential is common in the most densely populated urban settings, a large scale of ground floor retail is not viable in a suburban setting. TCG surveyed three mixed-use projects in Orange County, with ground level retail footprints ranging from 8,500 to 14,000 square feet. Two of the three projects were considered distressed, with elevated rates of retail vacancy (54% and 70%). Like the subject, each mixed-use analog lacks an anchor tenant magnet to attract consumers.

In summary, TCG considers the current land plan to be the highest and best use for the 4<sup>th</sup> and Cabrillo site.

\* \* \*

The above assignment was completed Michael Reynolds and David Prokopenko. Should you have any questions regarding the data or conclusions generated by the analysis, feel free to contact us at (949) 717-6450.

# EXHIBIT 16

1 - 289



**WATERFORD**  
PROPERTY COMPANY

130 Newport Center Drive, Ste. 230  
Newport Beach, CA 92660

**CENTRAL POINTE, 4<sup>th</sup> St. & Cabrillo Park  
Sunshine Ordinance Meeting**

**Meeting Minutes**

Date & Time: Thursday, August 15, 2019, 6:00 PM

Location: Creekside Plaza, 505 N. Tustin Ave., Suite 243, Santa Ana, Ca 92705

Purpose: Community meeting in compliance with the Sunshine Ordinance for Central Pointe at 4<sup>th</sup> St. & Cabrillo Park in Santa Ana

In Attendance: City Representatives: Vince Fregoso, Selena Kelaher, Scott Kutner, Mark McLoughlin  
Applicant: Sean Rawson and Consultant Team (KTYG/Architect, MJS/Landscape Architect and Debra Pember/Asst. Project Manager  
Members of the Public: 15 members were in attendance

The meeting began at approximately 6:05 pm. Sean Rawson, the applicant, introduced himself and his team. He provided an overview of the proposed project with a power point slide presentation, illustrating the conceptual elevations, floor plans, finishes, amenities and open space. It was emphasized that this is only a conceptual plan at this time. This is the first opportunity to get public feed-back. The following information was shared, followed by questions and comments.

- Project Zoning: The intent of the MEMU (Metro East Mixed-Use Overlay District) was explained and how the project complies with the zoning.
- Type of Project: 650 unit mixed-use residential project located in the Active Urban District. The mixed-use will include retail space on the first floors facing 4<sup>th</sup> Street. The project will create 500 jobs and bring \$36 million to the City in short-term income.
- Project has just recently been submitted to the City and no City feedback has been received since submittal.
- Project Amenities: The Landscape Architect, Matt Jackson, described the green open space open to the public and some of the roof top amenities that will be available to the residents, such as pools, fitness and clubrooms. A dog park is also being planned for the residents.
- Number of Units: Two buildings that total 650 luxury apartment units for rent, made up of studio units, one, two and some three-bedroom units. It was emphasized that this is conceptual as this point in time, until public and City feedback is received.

SPR No. 2020-04 1801 East Fourth Street  
Central Pointe Mixed-Use Development  
Exhibit 16 – Sunshine Meeting Minutes

Questions, Comments, Answers:

- Q. Target demographics?  
A. Millennial renters and empty nesters. Project will also comply with HOO (Housing Opportunity Ordinance).
- Q. Will there be affordable units on site?  
A. Reviewed options that support HOO and which option to pursue is being considered and not yet determined.
- Q. What types of businesses will occupy the retail component?  
A. Too soon to determine. Generally, the project needs to be built first and marketing for tenants will follow.
- Q. When will the project be started? What is the time frame for completion?  
A. We just started the entitlement process, which could take 10 to 12 months. After project is approved, the construction document phase starts, which with plan check, could take 8 to 10 months and then 30 months to build out.
- Q. Concern over dust impacts during construction.  
A. The EIR will identify all impacts and have specific requirements for mitigation.
- Q. Parking concerns: 650 units is 1,400 cars; project will have 2-3 residents per unit. What is the parking? Concern over parking spilling over into the neighborhoods (like Mabury cul-de-sacs) where not enough parking currently exists. Need to increase parking ratio. Is there parking onsite? What about visitors parking? What about parking for the retail?  
A. Parking is 1.82 spaces per unit and is consistent with the zoning. There is a parking structure for each building; it's considered a wrap design. We're hearing your concerns and the parking will be further studied through the entitlement period.
- Q. Concerns over traffic: Number of cars per unit; 650 units is 1,400 cars. Concerns with traffic using Mabury as a thorough fare to and from 17<sup>th</sup> St.  
A. A traffic study is being done. Everyone's comments and concerns will be considered and addressed.
- Q. Queuing going west on 4<sup>th</sup> St. is already difficult. How will this affect that?  
A. An additional traffic lane is being added.
- Q. Will there be consideration to add a bus route on 4<sup>th</sup> St.? Is it transit oriented?  
A. That's a question more for CalTrans. However, we are considering a shuttle service to/from the train station.
- Q. Will there be a sound wall along the freeway side?  
A. We don't know yet. Those are details that still need to be worked out through the process.
- Q. Utility poles, what's the status?  
A. They'll be undergrounded.

- Q. What is the roadway to west used for (on site plan)?  
A. That's actually a gated access for emergency vehicles only.
- Q. What is the sidewalk width going to be around the project?  
A. Not sure exactly, but those details will follow.
- Q. Will there be security on site?  
A. Some areas will be gated.
- Q. How far was the outreach? 500' is not enough, doesn't cover everyone. Should consider reaching out to neighboring communities. One couple talked about how they found out about the meeting through "Next Door". When is next meeting? How was it posted?  
A. Rules were followed within the City's guidelines for Sunshine Ordinance. It was posted in the paper, meeting notices mailed and posted signs on the property.
- Signs should also be posted at the Mabury curve.
- Q. When is the next meeting?  
A. The next meeting with the community will be hosted after the traffic study is complete.
- Q. What kind of landscaping is being proposed? (Desi) I don't like palm trees; they get tall and lose their value. I think you should plant pine trees; also wants boulders and some type of public art.  
A. Matt Jackson, project's landscape architect addressed the question. Tall, fuller type trees, vegetation will be placed along the freeway and other areas. However, typically, palm trees work well along storefronts or other commercial buildings, because they don't have a tendency to hide the signage.
- Q. Could you please bring more displays?  
A. Yes, definitely.
- Q. Will we be kept informed of all activities?  
A. Yes.
- Q. Could we have the next community meeting at the Cabrillo Park, maybe the tennis court area?  
A. Yes, we'll work on that.
- Additional comment: Desi stated his concerns, but added that "overall, likes the project".

Meeting adjourned approximately 7:15 PM

8/15/19

CENTRAL POINTE  
SIGN IN SHEET

Elsa Munsell 1437 S. Minnie #1 S.A cal  
714) 422-5399 92707

~~Desi Rapp~~  
Larry Hitterdale  
Edgar Velez

714-264-8473  
(714) 543-7118  
1437 Minnie St #5 Santa Ana CA. 92707  
714.227-5659

Jessie Lopez

Santa Ana 92701 714 amysod

Ruben Fernandez

Santa Ana 92705 Ruben.Fernandez@dot.ca.gov

Lazaro Vargas

Santa Ana 92701 714-791-9306

② Jorge Aguilar

Santa Ana 92701 714-315-8383

Socorro Donon

Santa Ana 92701 714-315-3559

MARK MCLOUGHAN

2415 N. RIVERSIDE DRIVE SA, CA 714-469-4208

Selena Kelaker

City of Santa Ana 714-007-2740

David Cordero

525 Cabrillo Park Dr, SA 92701 #125 714-245-9500

~~BARIS GRESEY~~

COSTA MESA, 92627 714-491-8239

Scott Kretzel

CITY OF SANTA ANA 714/667-2259

③ Tay Aston

1605 N. Linwood Ave 323 422-6315

① Jude Miranda

Santa Ana 92705 818 219 4955

Isuri Ramos

Santa Ana 92701 714 454 9451

↑ ↓ SALVADOR E. BUJAN Mayberry St. 714-263-5857

① Jude Miranda

jude.gabriel.miranda@gmail.com

② Jorge Aguilar

Jorge L. Aguilar@gmail.com

③ Tay Aston

taybird54@gmail.com



# REQUEST FOR Planning Commission Action



**PLANNING COMMISSION MEETING DATE:**  
**OCTOBER 26, 2020**

**TITLE:**  
**PUBLIC HEARING – ENVIRONMENTAL REVIEW  
NO. 2018-83, GENERAL PLAN AMENDMENT NO.  
2020-04, AMENDMENT APPLICATION NO. 2020-  
02, AND TENTATIVE TRACT MAP NO. 2019-02 TO  
FACILITATE CONSTRUCTION OF AN 8-UNIT  
CONDOMINIUM DEVELOPMENT AT 301 AND 305  
NORTH MOUNTAIN VIEW STREET**

**PLANNING COMMISSION SECRETARY**

APPROVED

- As Recommended
- As Amended
- Set Public Hearing For \_\_\_\_\_

DENIED

- Applicant's Request
- Staff Recommendation

Prepared by Jerry C. Guevara

CONTINUED TO \_\_\_\_\_

A blue ink signature of the Executive Director.

Executive Director

A black ink signature of the Planning Manager.

Planning Manager

## RECOMMENDED ACTION

1. Adopt a resolution adopting Mitigated Negative Declaration and Mitigation Monitoring and Reporting Program, Environmental Review No. 2018-83, for Tentative Tract Map No. 2019-02;
2. Adopt a resolution approving Tentative Tract Map No. 2019-02 as conditioned; and
3. Recommend that the City Council take the following actions:
  - a. Adopt a resolution adopting Mitigated Negative Declaration and Mitigation Monitoring and Reporting Program, Environmental Review No. 2018-83, for General Plan Amendment No. 2020-04 and Amendment Application No. 2020-02;
  - b. Adopt a resolution approving General Plan Amendment No. 2020-04; and
  - c. Adopt an ordinance approving Amendment Application No. 2020-02.

## Property Owner and Applicant Information

1. Owner: Mountain View Real Estate Investment, LLC
2. Applicant: Olympia Capital Corporation
3. Project Representative: Steve Jones

## Executive Summary

The applicant is requesting approval of multiple entitlements to facilitate construction of a new eight-unit condominium development at 301 and 305 North Mountain View Street. Specifically, the applicant is requesting approval of General Plan Amendment (GPA) No. 2020-04, Amendment Application (AA) No. 2020-02 and Tentative Tract Map (TM) No. 2019-02.

In accordance with the California Environmental Quality Act (CEQA), the project requires adoption of a Mitigated Negative Declaration (MND) and adoption of a Mitigation Monitoring and Reporting Program (MMRP), Environmental Review (ER) No. 2018-83, for the project.

Staff is recommending that the Planning Commission approve TTM No. 2019-02 as conditioned, and recommend approval of the applicant's GPA and AA request to the City Council as the project demonstrates high-quality site planning, design, and amenities, and contributes to the City's housing stock through both production of new home-ownership opportunities and payment of in-lieu affordable housing funds.

**Table 1: Project and Location Information**

Item	Information
Project Address	301 and 305 North Mountain View Street
Nearest Intersection	First and Mountain View streets
Existing General Plan Designation	Low-Medium Density Residential (LMR-11)
Proposed General Plan Designation	Medium Density Residential (MR-15)
Existing Zoning Designation	General Agricultural (A1)
Proposed Zoning Designation	Two-Family Residence (R2)
Surrounding Land Uses	North   Multiple-Family Residence
	East   Mobile Home Park
	South   Multiple-Family Residence
	West   Single-Family Residence
Site Size	0.74 acres
Existing Site Development	The site is currently developed with two single-family residences that were constructed in 1959 and 1963.
Applicable Zoning Code Sections	SAMC Chapter 41, Article II, Division 4 (SAMC Sections 41-246 to 41-256)
Entitlements	SAMC Chapter 41, Article V, Division II and Chapter 34, Article V

**Project Description**

The development is proposed to consist of four separate buildings, each with two units. The proposed units range in size from 1,800 to 1,870 square feet, each consisting of three bedrooms and an attached 400-square foot two-car garage.

**Table 2A: Unit Mix**

Unit	Building	Floor Area	Number of Bedrooms	Private Open Space
1	A	1,838 SF	3	360 SF
2	A	1,870 SF	3	685 SF
3	B	1,800 SF	3	685 SF
4	B	1,870 SF	3	540 SF
5	C	1,810 SF	3	540 SF
6	C	1,870 SF	3	685 SF
7	D	1,800 SF	3	685 SF
8	D	1,870 SF	3	850 SF
<b>TOTAL</b>		<b>14,728 SF</b>	<b>24</b>	<b>5,030 SF</b>

**Table 2B: R-2 Development Standards**

Standard	Required by SAMC		Provided
Minimum Lot Size	27,000 square feet		32,234 square feet; complies
Minimum Frontage	75 feet		108 feet; complies
Lot Coverage	50 percent		31 percent; complies
Building Height	27 feet		27 feet; complies
Front Yard Setback	20 feet		20 feet; complies
Side Yard Setback	5 feet		5-7 feet; complies
Rear Yard Setback	10 feet		10 feet; complies
Off-Street Parking	2 spaces per unit in a garage + 2 driveway spaces per unit		32 spaces; complies
Onsite Open Space	Private Open Space	100 square feet per unit	360 – 850 square feet per unit; complies
	Common Open Space	1,200 square feet	

The project's buildings are designed in a cohesive manner with unifying materials, floor heights, and articulation using contemporary architecture in a Spanish style and includes a variety of architectural elements such as smooth stucco, arches above windows and doors, tile and ironwork, and roof tiles.

The site will be accessed from a driveway at the southwest corner of the site, with an internal drive aisle providing access to each unit. The project provides two garage parking spaces per unit and two surface parking spaces per unit in each unit's driveway. In addition, communal bicycle racks are also provided at the center of the site.

The project provides an 835-square foot central common open space area between Buildings B and C. In addition, two 615-square foot common open space areas are provided, one between Buildings A and B and the other between Buildings C and D. The common open space areas will include grass play areas, benches, trash and recycle receptacles, bike racks, and pedestrian lighting. Private open space for each unit is provided through backyards and patios. As detailed in Table 2B, the backyards and patios range in size from 360 to 850 square feet.

**Project and Site Background**

The project site was originally developed in 1959 with a single-family residence; a second single-family residence was constructed in 1963. Both structures are proposed to be demolished as part of this application. In July 2018, the Planning Division received the subject application and, since then, the applicant has been working with the City to refine the site plan and elevations.

In accordance with the Sunshine Ordinance, the applicant held a community meeting on October 16, 2018 to review the proposed development and proposed land use and zoning changes and receive feedback from the community and adjacent property owners and residents. The applicant provided all the required information to the City after the meeting (Exhibit 12). In addition, the applicant provided an update to the community at the Riverview West Neighborhood Association meeting of August 25, 2020. The meeting was held at 6:15 p.m. via a GoToMeeting virtual platform which was attended by 12 residents. The community raised concerns about potential parking impacts to the neighborhood. Those concerns were addressed by clarifying that each unit is providing a two-car garage and two surface parking spaces for a total of 32 parking spaces for the

development site, which meets the City's required parking. In addition, all units will contain a maximum of three bedrooms.

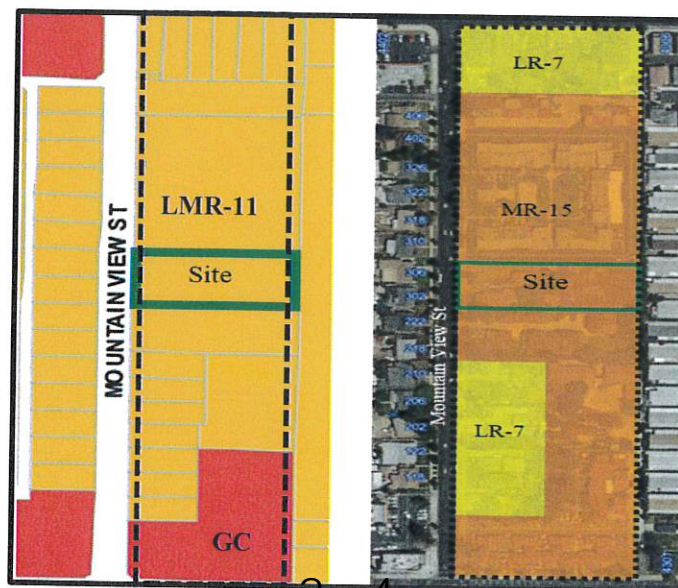
### **Analysis of the Issues**

#### **General Plan Amendment**

The applicant is requesting a GPA to change the subject site's current land use designation from Low-Medium Density Residential (LMR-11) to Medium Density Residential (MR-15) to create consistency between the General Plan Land Use Element and the Zoning Map. The MR-15 designation applies to those areas of the City that are developed with residential uses at densities of up to 15 units per acre. Development in this designation is characterized by duplexes, townhomes, or apartments. In reviewing a GPA request for a project such as the one proposed, the Planning Division's practice has been to also analyze any potential general plan land use inconsistencies in the general vicinity of the proposed project. Because of this and part of the this application, the City is also proposing to change the land use designation of the adjacent properties on the block stretching from First Street to Fifth Street to bring consistency between the Land Use Element and the Zoning Map. The proposed GPA for the entire area was discussed during the Sunshine Ordinance community meeting and is analyzed in the prepared MND.

Currently, the subject site and the surrounding properties on the east side of Mountain View Street have a LMR-11 or General Commercial (GC) land use designation. However, all of the properties are developed with residential uses with numerous properties currently exceeding the maximum allowed density permitted in the LMR-11 land use designation. The densities surrounding this area range from 4.8 to 18.8 dwelling units per acre. Because of this, staff is recommending that the general plan land use designation of the project site and surrounding properties be changed to MR-15 and Low Density Residential (LR-7), as shown on Map A. Changing the land use designations will bring the General Plan Land Use Plan into closer consistency with existing residential development density and characteristics in the area and will allow for consistent development intensity for future projects.

**Map A: Existing (Left) and Proposed (Right) Land Use Designations**



The project supports several goals and policies of the Housing Element. First, the project will be consistent with Goal 2, which encourages diversity of quality housing, affordability levels, and living experiences that accommodate Santa Ana's residents and workforce of all household types, income levels and age groups to foster an inclusive community. The proposed project will encourage the construction of entry level housing that will provide an opportunity for home ownership. Second, the project would support Goal 4, to provide adequate rental and ownership housing opportunities and supportive services. Further, the project would be consistent with Policy HE-2.4 to facilitate diverse types, prices and sizes of housing. The project would also be consistent with goals of the Land Use Element, including Goal 1 to promote a balance of land uses to address basic community needs, and Goal 6 to reduce residential overcrowding by promoting public health and safety. The proposed project will provide additional market rate housing in the City, thereby assisting in addressing the shortage of available housing within the region.

Amendment Application (Zone Change)

The applicant is also requesting to change the zoning designation of the property from General Agricultural (A1) to Two-Family Residence (R2). The R2 zoning designation is the appropriate designation for the subject site, which allows for duplexes and similar medium-density residential developments. In addition, staff is proposing to change the zoning designation of the surrounding properties to make the general plan and zoning consistent, as shown on Map B below. As it is unlikely that the existing uses will transition to agricultural related uses, a zone change is appropriate. The subject site and surrounding properties include properties zoned A1, R2, and Suburban Apartment (R4). In addition, the City is proposing to drop the Planned Residential Development (PRD) suffixes for three properties in order to streamline redevelopment of such properties, should they be redeveloped. The proposed AA for the entire area was discussed during the Sunshine Ordinance community meeting and is analyzed in the prepared MND.

**Map B: Existing (Left) and Proposed (Right) Zoning Designations**



Tentative Tract Map

The requested tentative tract map would allow subdivision of the property for condominium ownership purposes. Subdivision requests are governed by Chapter 34 and Chapter 41 of the SAMC. Pursuant to Section 66473.5 and 66474 of the California Subdivision Map Act (SMA), applications for tentative tract maps are approved when it can be shown that findings can be made in support of the request. Specifically, findings related to the proposal being consistent with the General Plan, the site is in conformance with all applicable City ordinances, the project site is physically suitable for the type and density of the proposed project, the proposed project will not cause substantial environmental damage or substantially and avoidably injure fish and wildlife or their habitat, the proposed project will not cause serious public health problems, or the proposed project will not conflict with easements necessary for public access through or use of the property must be made. Using this information staff has prepared the following analysis, which, in turn forms the basis for the recommendation contained in this report. In analyzing the applicant's request, staff believes that the following analysis warrants approval of the tentative tract map.

The applicant is seeking approval of a tentative parcel map to subdivide the property into eight airspace condominium units and one common area lot. The condominium units will contain approximately 1,900 square feet in size and the common lot will contain approximate 17,400 square feet. In reviewing the project, staff determined that the proposal as conditioned is consistent with the various provisions of the SAMC and General Plan, including lot size, lot frontage, and lot coverage. No adverse environmental impacts to fish or wildlife populations were identified as the project site is located in a built-out, urbanized area. In addition, conditions of approval are included requiring the applicant to enter into a property maintenance agreement and to submit Covenants, Conditions and Restrictions (CC&Rs) to the City for review. The CC&Rs will ensure long-term maintenance of the landscaping, parking, buildings, and common amenities. Finally, the tentative map is consistent with the California Subdivision Map Act and Chapters 34 and 41 of the Municipal Code.

**Table 3: CEQA, Public Notification, & Community Outreach**

<b>CEQA and Public Notification &amp; Community Outreach</b>		
<b>CEQA</b>		
CEQA Type	A Mitigated Negative Declaration (MND), Environmental Review No. 2019-83, with technical studies, was prepared for the project. No areas of significance or unavoidable impacts were determined to occur from the construction or operation of the proposed project (Exhibit 1). The project requires adoption of a Mitigation Monitoring and Reporting Program (MMRP), which contains mitigation measures to address biological resources, geology and soils, noise, hydrology and water quality, tribal cultural resources and cultural resources.	
Public Notification	On June 8, 2020, the draft MND was circulated for 30 days to interested parties and the Notice of Intent (NOI) was published in the Orange County Register and posted with the State's Clearinghouse. The draft MND was available for public review at the Santa Ana City Hall and on the project's webpage on the City's website.	
<b>Public Notification &amp; Community Outreach</b>		
Required Measures	Site posting	A public notice was posted on the project site on October 15, 2020.
	Notification by mail	Notification by mail was mailed to all property owners and occupants within 500 feet of the project site on October 15, 2020.

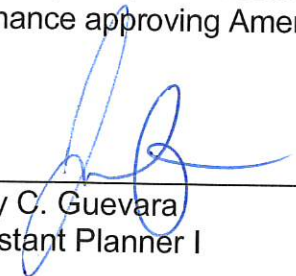
CEQA and Public Notification & Community Outreach	
	Newspaper posting Newspaper posting was published in the Orange County Register on October 15, 2020.
Sunshine Meeting	A Sunshine Ordinance Community Meeting was held on October 16, 2018 from 5:00 p.m. to 6:00 p.m. at Salgado Community Center in Rosita Park (706 North Newhope Street) in accordance with the provisions of the City's Sunshine Ordinance. A total of six members of the public attended. The applicant provided all the required information to the City after the meeting.
Additional Measures	The applicant provided a project update to the community at the Riverview West Neighborhood Association meeting of August 25, 2020.

**Economic Development**

Based on the development of the eight condominiums, the City is expected to generate approximately \$64,000 in permit fees. The project will also increase the property tax for the property. The property currently has an assessed value of approximately \$1.2 million. Upon completion of the project, the estimated assessed value of the property is approximately \$4 million. Based on the \$4 million valuation, the estimated annual tax revenue to the City is approximately \$5,200 (not including an expected two-percent annual increase).

**Conclusion**

Based on the analysis provided within this report, staff recommends that the Planning Commission adopt a resolution adopting Mitigated Negative Declaration and Mitigation Monitoring and Reporting Program, Environmental Review No. 2018-83, for Tentative Tract Map No. 2019-02 and adopt a resolution approving Tentative Tract Map No. 2019-02 as conditioned. Further staff recommends that the Planning Commission recommend that the City Council adopt a resolution adopting Mitigated Negative Declaration and Mitigation Monitoring and Reporting Program, Environmental Review No. 2018-83, for General Plan Amendment No. 2020-04 and Amendment Application No. 2020-02, adopt a resolution approving General Plan Amendment No. 2020-04, and adopt an ordinance approving Amendment Application No. 2020-02.

  
 \_\_\_\_\_  
 Jerry C. Guevara  
 Assistant Planner I

JG:\S:\Planning Commission\2020\10-12-20\GPA No. 2020-04, AA No. 2020-02 & TTM No. 2019-02 at 301 N. Mountain View Street\GPA-2020-04, AA No. 2020-02 & TM No. 2019-02. PC Staff Report.docx

Exhibits:

1. Planning Commission Resolution Adopting MND and MMRP, ER No. 2018-83, for TTM No. 2019-02
2. Planning Commission Resolution Approving TTM No. 2019-02, as conditioned
3. City Council Resolution Adopting MND and MMRP, ER No. 2018-83, for GPA No. 2020-04 and AA No. 2020-02
4. City Council Resolution Approving GPA No. 2020-04
5. City Council Ordinance Approving AA No. 2020-02
6. Vicinity Zoning and Aerial Map
7. Site Photo
8. Site Plan & Landscape Plan
9. Floor Plans
10. Elevations
11. Tentative Tract Map
12. Sunshine Ordinance Meeting Minutes



# **EXHIBIT 1**

## RESOLUTION NO. 2020-xx

A RESOLUTION OF THE PLANNING COMMISSION OF THE CITY OF SANTA ANA ADOPTING A MITIGATED NEGATIVE DECLARATION AND MITIGATION MONITORING AND REPORTING PROGRAM, ENVIRONMENTAL REVIEW NO. 2018-83, RELATIVE TO TENTATIVE TRACT MAP NO. 2019-02 FOR THE PROJECT LOCATED AT 301 AND 305 NORTH MOUNTAIN VIEW STREET

BE IT RESOLVED BY THE PLANNING COMMISSION OF THE CITY OF SANTA ANA AS FOLLOWS:

Section 1. The Planning Commission of the City of Santa Ana hereby finds, determines and declares as follows:

- A. Steve Jones with Olympia Capital Corporation, representing Mountain View Real Estate Investments, LLC. ("Applicant"), is requesting approval of Tentative Tract Map ("TTM") No. 2019-02 in order to facilitate the construction of an 8-unit condominium development at 301 and 305 North Mountain View Street.
- B. The provisions of the California Environmental Quality Act of 1970 ("CEQA"), Public Resources Code Sections 21000 et. seq., as amended, and the CEQA Guidelines require the evaluation of environmental impacts in connection with proposals for discretionary projects.
- C. Pursuant to the Guidelines for the Implementation of the CEQA, an Initial Study relative to the proposed project concluded that implementation of the project could result in potentially significant effects on the environment and identified mitigation measures that would reduce the significant effects to a less-than-significant level.
- D. The City of Santa Ana prepared a Mitigated Negative Declaration ("MND"), Environmental Review (ER) No. 2018-83, for the proposed project which reflects the City's independent judgement and analysis as lead agency for the project. The MND concluded that the project would have a less than significant environmental impact with implementation of mitigation measures. Mitigation measures are included to address biological resources, geology and soils, noise, hydrology and water quality, tribal cultural resources and cultural resources.
- E. On June 8, 2020, a Notice of Intent (NOI) to adopt the Initial Study and MND, ER No. 2018-83, was published in the Orange County Register newspaper, circulated to interested parties, and the State Clearinghouse.

- F. The documents related to the MND were made available for a 30-day public review and comment period at the Santa Ana City Hall and on the project's webpage on the City's website. At the completion of the comment period, comments from the Orange County Fire Authority (OCFA) and the Gabrieleno Ban of Mission Indians-Kizh Nation were received and incorporated to the Final MND.
- G. The mitigation measures set forth in the MND are fully enforceable and will be implemented using the Mitigation Monitoring and Reporting Program (MMRP), attached hereto as Exhibit A and incorporated herein by reference.
- H. On October 26, 2020, the Planning Commission of the City of Santa Ana held a duly noticed public hearing and voted to approve a resolution to adopt MND, ER No. 2018-83, and the related MMRP for the project.

Section 2. The Planning Commission has independently reviewed and analyzed the information contained in the Initial Study and the MND, ER No. 2018-83, prepared with respect to this project. The Planning Commission has, as a result of its consideration and the evidence presented at the hearings on this matter, determined that, as required pursuant to the CEQA and the State CEQA Guidelines, the MND adequately addresses the expected environmental impacts of this project. On the basis of this review, the Planning Commission finds that there is no substantial evidence from which it can be fairly argued that the project will have a significant adverse effect on the environment.

Section 3. The Planning Commission hereby adopts the MND, attached hereto as Exhibit A, and MMRP, attached hereto as Exhibit B, and directs that a Notice of Determination be prepared and filed with the County Clerk of the County of Orange in the manner required by law. This decision is based upon the evidence submitted at the above said hearing, which includes, but is not limited to: the Request for Planning Commission Action dated October 26, 2020 and exhibits attached hereto; and the public testimony, written and oral, all of which are incorporated herein by this reference.

Section 4. Pursuant to Title XIV, California Code of Regulations (CCR) § 735.5(c)(1), the Planning Commission has determined that, after considering the record as a whole, there is no evidence that the proposed project will have the potential for any significant adverse effect on wildlife resources or the ecological habitat upon which wildlife resources depend. The proposed project exists in an urban environment characterized by paved concrete, roadways, surrounding buildings and human activity. However, pursuant to Fish and Game Code § 711.2 and Title XIV, CCR § 735.5, the payment of Fish and Game Department filing fees in conjunction with this project is at the discretion of the State of California Department of Fish and Wildlife.

Section 5. The Applicant shall indemnify, protect, defend and hold the City and/or any of its officials, officers, employees, agents, departments, agencies, authorized volunteers, and instrumentalities thereof, harmless from any and all claims,

demands, lawsuits, writs of mandamus, referendum, and other proceedings (whether legal, equitable, declaratory, administrative or adjudicatory in nature), and alternative dispute resolution procedures (including, but not limited to arbitrations, mediations, and such other procedures), judgments, orders, and decisions (collectively "Actions"), brought against the City and/or any of its officials, officers, employees, agents, departments, agencies, and instrumentalities thereof, that challenge, attack, or seek to modify, set aside, void, or annul, any action of, or any permit or approval issued by the City and/or any of its officials, officers, employees, agents, departments, agencies, and instrumentalities thereof (including actions approved by the voters of the City) for or concerning the project, whether such Actions are brought under the Ralph M. Brown Act, California Environmental Quality Act, the Planning and Zoning Law, the Subdivision Map Act, Code of Civil Procedure sections 1085 or 1094.5, or any other federal, state or local constitution, statute, law, ordinance, charter, rule, regulation, or any decision of a court of competent jurisdiction. It is expressly agreed that the City shall have the right to approve, which approval will not be unreasonably withheld, the legal counsel providing the City's defense, and that Applicant shall reimburse the City for any costs and expenses directly and necessarily incurred by the City in the course of the defense. City shall promptly notify the Applicant of any Action brought and City shall cooperate with Applicant in the defense of the Action.

Section 6. This decision rendered by the Planning Commission of the City of Santa Ana is final and is subject to judicial review pursuant to California Code of Civil Procedure Section 1094.6. The Planning and Building Agency shall give direct notice to the Applicant of the Planning Commission's decisions and these findings.

Section 7. This resolution shall take effect immediately upon its adoption by Planning Commission, and the Recording Secretary shall attest to and certify the vote adopting this resolution.

ADOPTED this 26<sup>th</sup> day of October, 2020.

AYES: Commissioners:

NOES: Commissioners:

ABSENT: Commissioners:

ABSTENTIONS: Commissioners:

---

Mark McLoughlin  
Chairperson

**EXHIBIT A**  
**MITIGATED NEGATIVE DECLARATION**

The Mitigated Negative Declaration for the Project and Technical Studies are available online at:

<https://www.santa-ana.org/pb/planning-division/major-planning-projects-and-monthly-development-project-reports/mountain-view>

Or by visiting:

Planning and Building Agency – Planning Division Public Counter  
20 Civic Center Plaza  
Santa Ana, CA 92701

**EXHIBIT B**

**MITIGATION MONITORING AND REPORTING PROGRAM**

The following is a Mitigation Monitoring and Reporting Program (MMRP) for the Mountain View Avenue Condominiums located at 301 and 305 Mountain View Avenue, Santa Ana, CA. This MMRP has been prepared pursuant to Section 15097 of the California Environmental Quality Act (CEQA) Guidelines and Section 21081 of the Public Resources Code. The MMRP lists all applicable Project Mitigation Measures (MM) and environmental commitments that are required to be implemented with the Project under existing Standard Condition Plans, Programs, and Policies (SC) for implementing environmental resource protection legislation. This MMRP includes implementation timing and responsible party to ensure proper enforcement of all MM and SC to reduce Project impacts. The City of Santa Ana, as the Lead Agency, will utilize the MMRP to document the implementation of Project mitigation and SC environmental commitments, which ensure all project impacts are reduced to less than significance pursuant to the CEQA.

<b>Mitigation Number</b>	<b>Mitigation Measure</b>	<b>Responsible Party</b>	<b>Timing</b>	<b>Date Completed and Initials</b>
<b>AESTHETICS</b>				
MM AES-1	<p>The Contractor shall partition active areas of construction, stockpiles and materials storage locations; and, shall perform all work with downlighting and installation of a barrier to confine construction-related light and glare into active construction zones and to minimize spillover light and glare from construction equipment onto adjacent areas by implementing the following:</p> <p>(a) A temporary barrier between nearby residences and areas of active construction will be placed.</p> <p>(b) Temporary security lighting must be low voltage and downlit.</p>	Contractor and City Inspector	During all phases of construction	
<b>AIR QUALITY</b>				
MM AQ-1	Emissions controls and fugitive dust emissions controls will be implemented to reduce airborne dust contributing to PM10 and PM2.5 pursuant to SXAQMD Rules 403 for PM and PM2.5 and pursuant to Rule 1466 pertaining to toxic	Contractor as verified by City Planner and City Engineer, construction	During all phases of construction	

	<p>air contaminants. This includes dust control BACM and air quality TAC monitoring for Lead:</p> <ul style="list-style-type: none"> <li>(a) Designate a Dust Control Supervisor;</li> <li>(b) Provide PM10 monitoring both upwind and downwind during earth-moving activities;</li> <li>(c) Maintain records of earth-moving activities, monitoring, instrument calibration, manifest records for transport, volumes of materials with TAC, distances to a residence, park or school, and complaints;</li> <li>(d) Install minimum 6-foot tall barrier fencing where earth moving activities are carried out, and fencing at least as high as stockpiles;</li> <li>(e) Apply water or other soils stabilizers prior to earthmoving activities and maintain moisture content to prevent generation of visible dust plumes;</li> <li>(f) Post signs limiting speed limit to 15 miles per hour;</li> <li>(g) Stabilize or cover disturbed surfaces and apply stabilizers and cover haul loads prior to unloading;</li> <li>(h) Remove track-out with a vacuum equipped with filters rated to achieve 99.97% capture efficiency for 0.3 micron particles;</li> <li>(i) Prevent track-out and clean soils from the exterior of trucks, trailers and tires prior to leaving the Project Area;</li> </ul>	staff		
--	---	-------	--	--

	<ul style="list-style-type: none"> <li>(j) Segregate and label TAC stock piles and apply stabilizers, and 10mm plastic overlapping and anchored sheeting;</li> <li>(k) Cease activities during high winds (15 miles per hour over a 15-minute period or instantaneous wind speeds exceeding 25 MPH); and</li> <li>(l) Proper notification of SCAQMD prior to earthmoving</li> </ul>			
MM AQ-2	<p>Construction emissions will be reduced according to the following:</p> <ul style="list-style-type: none"> <li>(a) Disturbed areas will be stabilized at the end of each day with trench plates or similar devices.</li> <li>(b) Idling on construction equipment and vehicles will be limited to 5 minutes;</li> <li>(c) The project will implement Tier IV mitigation to reduce exhaust from diesel powered engines in compliance with AQMD;</li> <li>(d) The project will implement Tier III engines; and</li> <li>(e) Construction staff will carpool.</li> </ul>	Contractor as verified by City Planner and City Engineer, construction staff	During all phases of construction	
MM AQ-3	Project plans and specifications shall incorporate a temporary signage plan for the Project, which shall be verified by the City Engineer, and shall include a feedback phone number. The Contractor shall post Project Area will be with a phone number intended for 24/7 feedback to the Contractor and City from the community according to approved plans.	City Engineer, Contractor and City Inspector	During all phases of construction	
<b>BIOLOGY</b>				



APPROVED AS TO FORM:  
Sonia R. Carvalho, City Attorney

By: \_\_\_\_\_  
Lisa Storck  
Assistant City Attorney

CERTIFICATE OF ATTESTATION AND ORIGINALITY

I, SARAH BERNAL, Recording Secretary, do hereby attest to and certify the attached Resolution No. 2020-XX to be the original resolution adopted by the Planning Commission of the City of Santa Ana on October 26, 2020.

Date: \_\_\_\_\_

\_\_\_\_\_  
Recording Secretary  
City of Santa Ana

SC BIO-1	Plans and specifications for the project shall include the following note prior to issuance of permits to reduce impacts from vegetation trimming and clearing, tree trimming and removals, generation of mechanical noise or ground disturbance on active bird nests from native nesting birds: Active avian nests shall be avoided by the contractor by scheduling these construction activities outside of the avian breeding season, which is typically during February 1 to September 1.	Project proponent as verified by City Planner and Contractor as verified by City inspector.	Prior to issuance of permits during avian breeding season, Feb 1 – Sept 1 and verified throughout construction stages	
SC BIO-2	Plans and specifications for the project shall include the following note prior to issuance of permits to reduce impacts on nesting birds prior to commencement of work during the typical nesting season, the contractor shall hire a qualified biologist to conduct a nest survey, within the project boundaries and within a 1,000-foot radius buffer, three days in advance of the start of construction (for work beginning approximately between February 1 and September 1). This survey for bird nests will report the location of nesting birds that could be impacted by the project for species covered under the Migratory Bird Treaty Act and Fish and Game Code sections 3503, 3503.5, and 3513.	Project proponent as verified by the City Planner and Contractor as verified by City inspector, Project Biologist, Arborist	Prior to issuance of permits during avian breeding season, Feb 1 – Sept 1 and verified throughout construction stages	
SC BIO-3	Plans and specifications for the project shall include the following note prior to issuance of permits to reduce impacts on birds If active nests are found, the biologist will be retained for construction monitoring and to coordinate with CDFW on establishing specific buffers around nests that are sufficient to ensure that breeding is not likely to be disrupted or adversely impacted by construction pursuant to CDFW requirements. Buffers around active nests will be established pursuant to CDFW protocol or determination by a qualified CDFW biologist for smaller buffers which are sufficient to avoid impacts to nesting birds. Buffers will be maintained until young have fledged or the nests become inactive. Factors for consideration on nest buffers will include:	Project proponent as verified by the City Planner and Contractor as verified by City inspector, Project Biologist, Arborist	Prior to issuance of permits during avian breeding season, Feb 1 – Sept 1 and verified throughout construction stages	

	<p>(a) The presence of natural buffers provided by vegetation or topography;</p> <p>(b) nest height; and</p> <p>(c) locations of foraging territory; and baseline levels of noise and human activity.</p>			
<b>CULTURAL RESOURCES</b>				
SC CUL-1	Plans and specifications for the project shall include the following note prior to issuance of permits: If human remains are found, work in the location of the remains would cease and the Orange County Coroner's office would be contacted pursuant to Health and Safety Code Section 7050.5 to identify the appropriate next steps. If Native American remains are found, the most likely descendent would be notified pursuant to Section 5097.94 of the Public Resources Code.	Project proponent as verified by City Planner and Contractor as verified by City Inspector	Prior to issuance of permits and during construction	
<b>GEOLOGY AND SOILS</b>				
MM GEO-1	<p>Structural foundations preparation methods for foundations shall be incorporated into project specifications and plans and reviewed and approved by the Soils Engineer and Geotechnical Engineer for the project prior to issuance of a grading and building permits. Plans and Specifications shall include:</p> <p>(a) A minimum 3-foot compacted fill blanket below the bottom of footings or per the geologist recommendations based on final plans shall be implemented. For other minor structures like property line walls or retaining walls less than 4 feet high, competent native soils or compacted fill may be used;</p> <p>(b) Earthwork for foundation support shall include the entire building pad and shall extend a minimum of 5 feet outside exterior footing lines;</p>	Project proponent as verified by the City Engineer and Building Official	During Plan Check prior to issuance of permits and ongoing during Construction Inspection	

	<p>(c) Footing bottoms shall be observed by the geotechnical engineer to verify competent conditions;</p> <p>(d) Continuous spread footings placed a minimum depth of 24 inches below lowest adjacent finished grade may be used for the structures, with footing reinforcement with a minimum of two No. 4 bars (1 top and 1 bottom) and shall be observed by the geotechnical engineer to verify competent soil conditions; and</p> <p>(e) If a slab on grade is utilized, the slab shall be supported on engineered fill compacted to a minimum of 90 percent relative compaction. Slabs should be reinforced with at least No. 3 bars 18 inches on center both ways.</p>			
MM GEO-2	<p>Foundation plans and specifications shall be reviewed and approved by the Geologist and the Soil Engineer and shall incorporate the recommendations of the Geologist and Soil Engineer subgrade preparation prior to issuance of grading permits including the following measures:</p> <p>(a) The soil should be kept moist prior to casting the slab, and if the soils at grade become disturbed during construction, they should be brought to approximately optimum moisture content, and rolled to a firm, unyielding condition prior to placing concrete.</p> <p>(b) In areas where a moisture sensitive floor covering will be used, a vapor barrier consisting of a plastic film (6 ml polyvinyl chloride or equivalent) should be used.</p>	Project proponent as verified by the City Engineer and Building Official	During Plan Check prior to issuance of permits and during Construction Inspection	

	<p>The vapor barrier should be properly lapped and sealed.</p> <p>(c) Hardscape and slab subgrade areas shall exhibit a minimum of 90 percent relative compaction to a depth of at least 1 foot. Deeper removal and re-compaction may be required if unacceptable conditions are encountered. These areas require testing for compaction just prior to placing concrete.</p> <p>(d) Site grading shall incorporate drainage directed away from structures via non-erodible conduits to detention areas. The structure should utilize roof gutters and down spouts tied directly to yard drainage.</p> <p>(e) Unlined flower beds, planters, and lawns should not be constructed against the perimeter of the structure. If such landscaping (against the perimeter of a structure) is planned, it should be properly drained and lined or provided with an underground moisture barrier and irrigation in these areas should be kept to a minimum.</p>			
MM GEO-3	<p>Grading plans and specifications for the project shall be reviewed and approved by the Soil and Geotechnical Engineers and shall include the recommendations of the Soil Engineer and Geotechnical Engineer including the following:</p> <p>(a) After the foundation for the fill has been cleared, plowed or scarified, it shall be disced or bladed until it is uniform and free from large clods, brought to a proper moisture content and compacted to not less than 90 percent of the</p>	Project proponent as verified by City Engineer	During Plan Check and Construction Inspections	

	<p>maximum dry density in accordance with ASTM:D-1557 (5 layers -25 blows per layer; 10 lb. hammer dropped 18"; 4" diameter mold).</p>			
MM GEO-4	<p><b>MM GEO – 4:</b> The Soil Engineer shall provide continuous supervision of the site clearing and grading operation so that he can verify the grading was done in accordance with the accepted plans and specifications including the following provisions a through w:</p> <ul style="list-style-type: none"> <li>a) All grading shall consist of removal and re-compaction of soft surficial soils.</li> <li>b) All existing vegetation shall be stripped and hauled from the site.</li> <li>c) On-site materials may be used for fill, or fill materials shall consist of materials approved by the Soils Engineer and may be obtained from the excavation of banks, borrow pits or any other approved source. The materials used should be free of vegetable matter and other deleterious substances and shall not contain rocks or lumps greater than 8 inches in maximum dimension.</li> <li>d) The selected fill material shall be placed in layers which, when compacted, shall not exceed 6 inches in thickness. Each layer shall be spread evenly and shall be thoroughly mixed during the spreading to ensure uniformity of material and moisture of each layer.</li> <li>e) No fill material shall be placed, spread or rolled during unfavorable weather conditions.</li> </ul>	Contractor as verified by City Building Official/ Inspector	Ongoing During Construction	

	<p>f) When work is interrupted by heavy rains, fill operations shall not be resumed until the field tests by the Soils Engineer indicate the moisture content and density of the fill are as previously specified.</p> <p>g) Where moisture of the fill material is below the limits specified by the Soils Engineer, water shall be added until the moisture content is as required to ensure thorough bonding and thorough compaction.</p> <p>h) Where moisture content of the fill material is above the limits specified by the Soils Engineer, the fill materials shall be aerated by blading or other satisfactory methods until the moisture content is as specified by the Soils Engineer.</p> <p>i) After each layer has been placed, mixed and spread evenly, it shall be thoroughly compacted to not less than 90 percent of the maximum dry density in accordance with ASTM:D-1557 (5 layers -25 blows per layer; 10 lbs. hammer dropped 18 inches; 4" diameter mold) or other density tests which will attain equivalent results.</p> <p>j) Compaction shall be by sheepsfoot roller, multi-wheel pneumatic tire roller or other types of acceptable rollers.</p> <p>k) Rollers shall be of such design that they will be able to compact the fill to the specified density. Rolling</p>			
--	---	--	--	--

	<p>shall be accomplished while the fill material is at the specified moisture content.</p> <ul style="list-style-type: none"> <li>l) Rolling of each layer shall be continuous over the entire area and the roller shall make sufficient trips to ensure that the desired density has been obtained. The final surface of the lot areas to receive slabs on grade should be rolled to a dense, smooth surface.</li> <li>m) The outside of all fill slopes shall be compacted by means of sheepsfoot rollers or other suitable equipment.</li> <li>n) Compaction operations shall be continued until the outer 9 inches of the slope is at least 90 percent compacted. Compacting of the slopes may be progressively in increments of 3 feet to 5 feet of fill height as the fill is brought to grade, or after the fill is brought to its total height.</li> <li>o) Field density tests shall be made by the Soils Engineer of the compaction of each layer of fill.</li> <li>p) Density tests shall be made at intervals not to exceed 2 feet of fill height provided all layers are tested.</li> <li>q) Where the sheepsfoot rollers are used, the soil may be disturbed to a depth of several inches and density readings shall be taken in the compacted material below the disturbed surface.</li> <li>r) When these readings indicate that the density of any layer of fill or portion there is below the required 90 percent</li> </ul>			
--	--	--	--	--



	<p>density, the particular layer or portion shall be reworked until the required density has been obtained.</p> <p>s) Removal and re-compaction of existing fill and loose native soils will be required to provide adequate support for foundations and slabs on grade.</p> <p>t) Removals shall extend downward into competent earth materials or to at least 2 feet below proposed footing bottoms, whichever is deeper.</p> <p>u) The exposed excavation bottom shall be observed and approved by the Geotechnical Engineer. Subsequent to approval of the excavation bottom, the area shall be scarified 6 inches, moisture conditioned as needed, and compacted to a minimum of 90 percent relative compaction.</p> <p>v) Fill soils shall be placed in 6 to 8-inch loose lifts, moisture conditioned as needed, and compacted to a minimum of 90 percent relative compaction up to finish grade.</p> <p>w) All utility line backfills, both interior and exterior, shall consist of clean sand and gravel, and be compacted to a minimum of 90 percent relative compaction and shall require testing at a maximum of 2-foot vertical intervals.</p>			
MM GEO-5	In the event that buried paleontological resources or geologic features are encountered during grading, work in the area of the find shall cease and a	Contractor and Building Official/ Inspector	Ongoing during Construction	

	qualified paleontologist or geologist shall inspect the resources and determine the appropriate course of action for further treatment.			
<b>HYDROLOGY AND WATER QUALITY</b>				
SC HYD-1	<p>Prior to issuance of building and grading permits, structural BMPs shall be incorporated into the final development plans and specifications for the project and prior to final tract map approval, non-structural BMPs shall be incorporated into CC&amp;Rs for Condominium Tract 19064 including but not limited to the following:</p> <ul style="list-style-type: none"> <li>a) Permeable driveway paving system with filtered storm drain inlets designed to detain 80 percent of 100-year storm flows from the APN 100-281-05 shall be incorporated into project plans and specifications and maintained through the HOA and CC&amp;Rs.</li> <li>b) Pet Waste Stations including bags and covered receptacle shall be incorporated into project plans and funded/maintained through the HOA and CC&amp;Rs.</li> <li>c) Covered trash receptacles shall be included in the common area on the final plans and maintained by the HOA through CC&amp;Rs.</li> <li>d) Owner education materials, including proper handling, storage and disposal of toxics and maintenance of yard drains shall be incorporated into CC&amp;Rs for the tract.</li> </ul>	Project Proponent as verified by the City Engineer and Building Official/ Inspector	During Plan Check and Ongoing During Construction	
SC HYD-2	Prior to issuance of permits for the project, water efficient landscaping and irrigation details shall be incorporated into development plans and specifications for the project.	Project Proponent as verified by the City Engineer and Building	During Plan Check and Ongoing During Construction	

		Official/Inspector		
SC HYD-3	<p>Prior to issuance of grading and building permits, erosion control measures shall be included in final plans and specifications including but not limited to provisions a-d below:</p> <ul style="list-style-type: none"> <li>a) Twice daily minimum sweeping of track-out areas.</li> <li>b) Cover haul loads and stockpiles with tarps.</li> <li>c) Maintain adequate soil moisture in disturbed surfaces during and after grading.</li> <li>d) Reduce construction vehicle speeds and idling times.</li> </ul>	Project Proponent as verified by the City Engineer and Building Official/Inspector	During Plan Check and Ongoing During Construction	
<b>NOISE</b>				
MM NOI-1	<p>Final plans and specifications for the project shall include a note as follows: During demolition and construction, the contractor shall install noise source reduction or noise barriers and shall measure the effectiveness of said noise mitigation to document that project construction does not exceed the FTA threshold of 80 dB at nearby residential land uses. Said noise mitigation shall include but not be limited to the following:</p> <ul style="list-style-type: none"> <li>a) Shall fit equipment at the project site mufflers providing at least 8 dB of noise reduction, or</li> <li>b) Shall construct temporary enclosures or acoustical tents that provide at least 8 dB of noise; and</li> <li>c) Shall measure and document the effectiveness of the implemented noise abatement measures</li> </ul>	Project Proponent as verified by the Building Official and Building Inspector	During Plan Check and Ongoing During Construction	
<b>TRIBAL CULTURAL RESOURCES</b>				
MM TRI-1	Prior to the issuance of any permits for	City Building	During Plan	

	<p>initial site clearing (such as pavement removal, grubbing, tree removals) or issuance of permits allowing ground disturbing activities that cause excavation to depths greater than artificial fill (including as boring, grading, excavation, drilling, potholing or auguring, and trenching), the City of Santa Ana shall ensure that the project applicant/developer retain qualified Native American Monitor(s). The monitor(s) shall be approved by the tribal representatives of the Gabrieleno Band of Mission Indians - Kizh Nation and be present on-site during initial site clearing and construction that involves ground disturbing activities that cause excavation to depths greater than artificial fill identified herein. The monitor shall conduct a Native American Indian Sensitivity Training for construction personnel. The training session includes a handout and focus on how to identify Native American resources encountered during earthmoving activities and the procedures followed if resources are discovered. The Native American monitor(s) shall complete monitoring logs on a daily basis, providing descriptions of the daily activities, including construction activities, locations, soil, and any cultural materials identified. The on-site monitoring shall end when grading and excavation activities of native soil (i.e., previously undisturbed) are completed, or when the tribal representatives and monitor have indicated that the site has a low potential for tribal cultural resources, whichever occurs first.</p>	<p>Official and City Planning Department</p>	<p>Check prior to issuance of permits and ongoing during construction</p>	
<p>MM TRI-2</p>	<p>In the event that tribal cultural resources are inadvertently discovered during ground disturbing activities, work must be halted within 50 feet of the find until it can be evaluated by a qualified archaeologist in cooperation with a Native American monitor to determine if the potential resource meets the CEQA definition of historical (State CEQA Guidelines 15064.5(a)) and/or unique resource (Public Resources</p>	<p>Official and City Planning Department</p>	<p>Check prior to issuance of permits and ongoing during construction</p>	

	<p>Code 21083.2(g)). Construction activities could continue in other areas. If the find is considered an "archeological resource" the archaeologist, in cooperation with a Native American monitor shall pursue either protection in place or recovery, salvage and treatment of the deposits. Recovery, salvage and treatment protocols shall be developed in accordance with applicable provisions of Public Resource Code Section 21083.2 and State CEQA Guidelines 15064.5 and 15126.4. If unique a tribal cultural resource cannot be preserved in place or left in an undisturbed state, recovery, salvage and treatment shall be required at the Project applicant's expense. All recovered and salvaged resources shall be prepared to the point of identification and permanent preservation in an established accredited professional repository.</p>			
--	---	--	--	--

## **EXHIBIT 2**

## RESOLUTION NO. 2020-xx

A RESOLUTION OF THE PLANNING COMMISSION OF THE CITY OF SANTA ANA APPROVING TENTATIVE TRACT MAP NO. 2019-02 AS CONDITIONED TO CREATE A SUBDIVISION OF EIGHT (8) CONDOMINIUM UNITS AT 301 AND 305 NORTH MOUNTAIN VIEW STREET

BE IT RESOLVED BY THE PLANNING COMMISSION OF THE CITY OF SANTA ANA AS FOLLOWS:

Section 1. The Planning Commission of the City of Santa Ana hereby finds, determines and declares as follows:

- A. Steve Jones with Olympia Capital Corporation, representing Mountain View Real Estate Investments, LLC. ("Applicant"), is requesting approval Tentative Tract Map ("TTM") No. 2019-02 to facilitate the construction of an 8-unit condominium development at 301 and 305 North Mountain View Street.
- B. On October 26, 2020, the Planning Commission of the City of Santa Ana held a duly noticed public hearing to consider all testimony, written and oral, related to TTM No. 2019-02, at which time all persons wishing to testify were heard, the project was fully considered, and all other legal prerequisites to the adoption of this resolution occurred.
- C. Subdivision requests are governed by Chapter 34 and Chapter 41 of the Santa Ana Municipal Code ("SAMC"). Pursuant to Section 66473.5 and 66474 of the California Subdivision Map Act ("SMA"), applications for tentative tract maps are approved when certain findings can be established.
- D. The Planning Commission of the City of Santa Ana determines that the following findings, which must be established in order to approve TTM No. 2019-02, have been established as required by Section 34-127 of the SAMC and the SMA:
  1. The proposed project and its design and improvements are consistent with the proposed Medium Density Residential (MR-15) land use designation of the General Plan and are otherwise consistent with all other Elements of the General Plan.

The proposed project and its design and improvements are consistent with various provisions of the City's Zoning Code and General Plan with approval of General Plan Amendment (GPA) No. 2020-04, which amends the land use designation of the property to Medium Density Residential (MR-15) and

allows a maximum development density of 15 units per acre. The proposed project is consistent with the designation at a density of 15 dwelling units per acre. In addition, the project supports several goals and policies of the General Plan. Specifically, the project is consistent with General Plan Land Use Element, Goal 1 to promote a balance of land uses to address basic community needs. Policy 1.5 encourages the maintenance and fostering of a variety of residential land uses. The project will provide eight for-sale condominium units. Policy 2.10 supports new development which is harmonious in scale and character with existing development in the area. The project is similar in scale and character to the adjacent multi-family uses. Policy 3.1 supports development which provides a positive contribution to neighborhood character and identity. The project will allow for redevelopment of a vacant lot with a new residential development with a contemporary design and variety of building materials. Goal 2 of the Housing Elements encourages a diversity of quality housing, affordability levels, and living experiences that accommodate Santa Ana's residents and workforce of all household types, income levels. Further, Policy 2.5 of the Housing Element encourages developments that facilitate diverse types, prices and size of housing, including single-family homes, apartments, townhomes, mixed/multi-use housing, transit oriented housing, multi-generational housing and live work opportunities. The project will provide a for-sale product with units that range in size that are targeted to entry level home ownership.

2. The proposed project conforms to all applicable requirements of the zoning and subdivision codes as well as other applicable City ordinances.

The proposed project is consistent with the City's zoning with approval of Amendment Application (AA) No. 2020-02, which amends the zoning designation of the property to Two-Family Residence (R2). The R2 zoning designation allows for two family residences. The minimum development site size is 27,000 square feet with a minimum street frontage of 75 feet. The proposed lot complies with the minimum lot size and lot frontage. In addition, Covenants, Conditions and Restrictions (CC&Rs) will address issues such as drainage, reciprocal access, landscaping and maintenance and will be recorded prior to approval of the final map and is therefore consistent with Chapter 34 of the SAMC and the SMA.



3. The project site is physically suitable for the type and density of the proposed project.

The project site is physically suitable for the type and density of the proposed project. There are no physical constraints on the site that would preclude development. The proposed site consists of approximately 0.74 acres of land and is physically suitable for the proposed development. The lot size, density, width, and lot coverage are consistent with the existing surrounding properties in the neighborhood and with the R-2 zoning district development standards.

4. The design and improvements of the proposed project will not cause substantial environmental damage or substantially and avoidably injure fish and wildlife or their habitat.

The design and improvements of the proposed project will not cause substantial environmental damage or substantially and avoidably injure fish and wildlife or their habitat. The project is located in an urbanized area, there are no known fish or wildlife populations existing on the project site. Therefore, the proposed subdivision will not cause any substantial environmental damage or substantially and avoidably injure fish and wildlife or their habitat.

5. The design or improvements of the proposed project will not cause serious public health problems.

The design or improvements of the proposed project will not cause serious health problems. The subdivision will not have any detrimental effects upon the general public. The property will include necessary utilities and infrastructure improvements as required by the SAMC and SMA.

6. The design or improvements of the proposed project will not conflict with easements necessary for public access through or use of the property within the proposed project.

The design and improvements of the project will not conflict with easements necessary for public access or use of the property within the proposed project. In addition, the CC&Rs will ensure reciprocal access rights and maintenance agreements between properties.

Section 2. The Planning Commission has reviewed and considered the information contained in the initial study and the Mitigated Negative Declaration (MND), Environmental Review (ER) No. 2018-83, prepared with respect to this project. The Planning Commission has, as a result of its consideration and the evidence presented at the hearings on this matter, determined that, as required pursuant to the California Environmental Quality Act (CEQA) and the State CEQA Guidelines, the MND adequately addresses the expected environmental impacts of this project. There is no evidence from which it can be fairly argued that the project will have a significant adverse effect on the environment.

Section 3. The Applicant shall indemnify, protect, defend and hold the City and/or any of its officials, officers, employees, agents, departments, agencies, authorized volunteers, and instrumentalities thereof, harmless from any and all claims, demands, lawsuits, writs of mandamus, referendum, and other proceedings (whether legal, equitable, declaratory, administrative or adjudicatory in nature), and alternative dispute resolution procedures (including, but not limited to arbitrations, mediations, and such other procedures), judgments, orders, and decisions (collectively "Actions"), brought against the City and/or any of its officials, officers, employees, agents, departments, agencies, and instrumentalities thereof, that challenge, attack, or seek to modify, set aside, void, or annul, any action of, or any permit or approval issued by the City and/or any of its officials, officers, employees, agents, departments, agencies, and instrumentalities thereof (including actions approved by the voters of the City) for or concerning the project, whether such Actions are brought under the Ralph M. Brown Act, California Environmental Quality Act, the Planning and Zoning Law, the Subdivision Map Act, Code of Civil Procedure sections 1085 or 1094.5, or any other federal, state or local constitution, statute, law, ordinance, charter, rule, regulation, or any decision of a court of competent jurisdiction. It is expressly agreed that the City shall have the right to approve, which approval will not be unreasonably withheld, the legal counsel providing the City's defense, and that Applicant shall reimburse the City for any costs and expenses directly and necessarily incurred by the City in the course of the defense. City shall promptly notify the Applicant of any Action brought and City shall cooperate with Applicant in the defense of the Action.

Section 4. The Planning Commission of the City of Santa Ana, after conducting the public hearing, hereby approves TTM No. 2019-02 as conditioned in Exhibit A, attached hereto and incorporated as though fully set forth herein. This decision is based upon the evidence submitted at the above said hearing, which includes, but is not limited to: the Request for Planning Commission Action dated October 26, 2020, and exhibits attached thereto, and the public testimony, written and oral, all of which are incorporated herein by this reference.

Section 5. TTM No. 2019-02 shall not be effective until the City Council reviews and approves General Plan Amendment No. 2020-04 and Amendment Application No. 2020-02 for the subject project. If said approvals are held to be invalid or unconstitutional by the

decision of any court of competent jurisdiction, or otherwise denied, then this TTM shall be null and void and have no further force and effect.

ADOPTED this 26<sup>th</sup> day of October, 2020.

AYES: Commissioners:

NOES: Commissioners:

ABSENT: Commissioners:

ABSTENTIONS: Commissioners:

\_\_\_\_\_  
Mark McLoughlin  
Chairperson

APPROVED AS TO FORM:  
Sonia R. Carvalho, City Attorney

By: \_\_\_\_\_  
Lisa Storck  
Assistant City Attorney

**CERTIFICATE OF ATTESTATION AND ORIGINALITY**

I, SARAH BERNAL, Recording Secretary, do hereby attest to and certify the attached Resolution No. 2020-xx to be the original resolution adopted by the Planning Commission of the City of Santa Ana on October 26, 2020.

Date: \_\_\_\_\_

\_\_\_\_\_  
Recording Secretary  
City of Santa Ana

## EXHIBIT A

### **Conditions of Approval for Tentative Tract Map No. 2019-02**

Tentative Tract Map No. 2019-02 is approved subject to compliance, to the reasonable satisfaction of the Planning Manager, with applicable sections of the Santa Ana Municipal Code, the California Administrative Code, the California Building Standards Code, the California Subdivision Map Act, and all other applicable regulations. In addition, the following conditions of approval are applicable:

The Applicant must comply with each and every condition listed below prior to exercising the rights conferred by this tentative tract map.

The Applicant must remain in compliance with all conditions listed below throughout the life of the development project. Failure to comply with each and every condition may result in the revocation of the tentative tract map.

1. All proposed site improvements must conform to the Development Project plan approved per DP No. 2018-22 and the staff report exhibits included within this report and are incorporated herein by reference.
2. Any amendment to this tentative tract map, including modifications to approved materials, finishes, architecture, site plan, landscaping, parking, and square footages, must be submitted to the Planning Division for review. At that time, staff will determine if administrative relief is available or if the site plan review must be amended.
3. Prior to the issuance of a building permit, a full landscape and irrigation plan is to be submitted for review and approval by the Planning Division. The landscape plan shall conform to the R-2 landscape standards, Citywide Design Guidelines, and the City's Water Efficient Landscape Ordinance.
4. Applicant must submit Covenants, Conditions and Restrictions (CC&Rs) for the project to the Planning Division for review and approval prior to the Final Map being recorded.
5. The Final Map must be approved and recorded prior to issuance of Building permits.
6. The Final Map and all improvements required to be made or installed by the subdivider must be in accordance with the design standards and specifications of the Santa Ana Municipal Code and the requirements of the State Subdivision Map Act.

7. Two copies of the recorded Final Map and CC&Rs shall be submitted to the Planning Division, Building Division, Public Works Agency and Orange County Fire Authority (OCFA) within 10 days of recordation.
8. A Property Maintenance Agreement shall be recorded prior to the issuance of Building permits and shall be subject to review and approval by the Planning and Building Agency, the Community Development Agency, the Public Works Agency, and the City Attorney to ensure that the property and all improvements located thereupon are properly maintained. Applicant (and the owner of the property upon which the authorized use and/or authorized improvements are located if different from the Applicant) shall execute a maintenance agreement or incorporate the form of this condition within the Projects CC&R's with the City of Santa Ana which shall be recorded against the property and which shall be in a form reasonably satisfactory to the City Attorney. The maintenance agreement shall contain covenants, conditions and restrictions relating to the following:
  - a. Compliance with operational conditions applicable during any period(s) of construction or major repair (e.g., proper screening and securing of the construction site; implementation of proper erosion control, dust control and noise mitigation measure; adherence to approved project phasing etc.);
  - b. Compliance with ongoing operational conditions, requirements and restrictions, as applicable (including but not limited to hours of operation, security requirements, the proper storage and disposal of trash and debris, enforcement of the parking management plan, and/or restrictions on certain uses;
  - c. Ongoing compliance with approved design and construction parameters, signage parameters and restrictions as well as landscape designs, as applicable;
  - d. Ongoing maintenance, repair and upkeep of the property and all improvements located thereupon (including but not limited to controls on the proliferation of trash and debris about the property; the proper and timely removal of graffiti; the timely maintenance, repair and upkeep of damaged, vandalized and/or weathered buildings, structures and/or improvements; the timely maintenance, repair and upkeep of exterior paint, parking striping, lighting and irrigation fixtures, walls and fencing, publicly accessible bathrooms and bathroom fixtures, landscaping and related landscape improvements and the like, as applicable);
  - e. If Applicant and the owner of the property are different (e.g., if the Applicant is a tenant or licensee of the property or any portion thereof),

both the Applicant and the owner of the property shall be signatories to the maintenance agreement and both shall be jointly and severally liable for compliance with its terms;

- f. The maintenance agreement shall further provide that any party responsible for complying with its terms shall not assign its ownership interest in the property or any interest in any lease, sublease, license or sublicense, unless the prospective assignee agrees in writing to assume all of the duties and obligations and responsibilities set forth under the maintenance agreement;
- g. The maintenance agreement shall contain provisions relating to the enforcement of its conditions by the City and shall also contain provisions authorizing the City to recover costs and expenses which the City may incur arising out of any enforcement and/or remediation efforts which the City may undertake in order to cure any deficiency in maintenance, repair or upkeep or to enforce any restrictions or conditions upon the use of the property. The maintenance agreement shall further provide that any unreimbursed costs and/or expenses incurred by the City to cure a deficiency in maintenance or to enforce use restrictions shall become a lien upon the property in an amount equivalent to the actual costs and/or expense incurred by the City; and
- h. The execution and recordation of the maintenance agreement shall be a condition precedent to the final map being recorded.

# **EXHIBIT 3**

RESOLUTION NO. 2020-xx

A RESOLUTION OF CITY COUNCIL OF THE CITY OF SANTA ANA ADOPTING A MITIGATED NEGATIVE DECLARATION AND MITIGATION MONITORING AND REPORTING PROGRAM, ENVIRONMENTAL REVIEW NO. 2018-83, RELATIVE TO GENERAL PLAN AMENDMENT NO. 2020-04 AND AMENDMENT APPLICATION NO. 2020-02 FOR THE PROJECT LOCATED AT 301 AND 305 NORTH MOUNTAIN VIEW STREET

BE IT RESOLVED BY THE CITY COUNCIL OF THE CITY OF SANTA ANA AS FOLLOWS:

Section 1. The City Council of the City of Santa Ana hereby finds, determines and declares as follows:

- A. Steve Jones with Olympia Capital Corporation, representing Mountain View Real Estate Investments, LLC. ("Applicant"), is requesting approval of General Plan Amendment (GPA) No. 2020-04 to amend the General Plan land use designation of the project site from Low Medium Density Residential (LMR-11) to Medium Density Residential (MR-15) and Amendment Application (AA) No. 2020-02 to change the zoning designation of the project site from General Agricultural (A1) to Two-Family Residence (R2) in order to facilitate the construction of an 8-unit condominium development at 301 and 305 North Mountain View Street.
- B. In addition, the City of Santa Ana is proposing to change the land use designation of the properties located at 4310, 4314, 4318, 4322, 4326, and 4330 West Fifth Street, 113, 117, 121, 201, 203, 207 and 211 North Mountain View Street from LMR-11 to Low Density Residential (LR-7); 221, 223, 225, 227, 229, 231, 233, 235, 237, 239, 241, 243, 245, 247, 301, 305, 321, 323, 325, 327, 329, 331, 333, 335, 337, 339, 341, 343, 345, 347, 349, 351, 353, 355, 357, 359, 361, 363, 365, 409 and 411 North Mountain View Street and 4311 West First Street from LMR-11 to MR-15; and 4315, 4317, 4319, 4321, 4323, 4325, 4327, 4329, 4331, 4333, 4335, 4337 and 4339 West First Street from General Commercial (GC) to MR-25.
- C. Lastly, the City of Santa Ana is also proposing to change the zoning designation of the properties located at 4310, 4314, 4318, 4322, 4326 and 4330 West Fifth Street, 4311 West First Street and 113, 117, 121, 201, 203, 207 and 211 North Mountain View Street from A1 to Single-Family Residence (R1); and 221, 223, 225, 227, 229, 231, 233, 235, 237, 239, 241, 243, 245, and 247 North Mountain View Street from Suburban Apartment (R4) to R2.



- D. The provisions of the California Environmental Quality Act of 1970 (CEQA), Public Resources Code Sections 21000 et. seq., as amended, and the CEQA Guidelines require the evaluation of environmental impacts in connection with proposals for discretionary projects.
- E. Pursuant to the Guidelines for the Implementation of the CEQA, an Initial Study relative to the proposed project concluded that implementation of the project could result in potentially significant effects on the environment and identified mitigation measures for the development site (301 and 305 North Mountain View Street) that would reduce the significant effects to a less-than-significant level.
- F. The City of Santa Ana prepared a Mitigated Negative Declaration (MND), Environmental Review (ER) No. 2018-83, for the proposed project which reflects the City's independent judgement and analysis as lead agency for the project. The MND concluded that the project site would have a less than significant environmental impact with implementation of mitigation measures. Mitigation measures are included to address biological resources, geology and soils, noise, hydrology and water quality, tribal cultural resources and cultural resources.
- G. On June 8, 2020, a Notice of Intent (NOI) to adopt the Initial Study and MND, ER No. 2018-83, was published in the Orange County Register newspaper, circulated to interested parties, and the State Clearinghouse.
- H. The documents related to the MND were made available for a 30-day public review and comment period at the Santa Ana City Hall and on the project's webpage on the City's website. At the completion of the comment period, comments from Orange County Fire Authority (OCFA) and the Gabrieleno Ban of Mission Indians-Kizh Nation were received and incorporated to the Final MND.
- I. The mitigation measures set forth in the MND are fully enforceable and will be implemented using the Mitigation Monitoring and Reporting Program (MMRP), attached hereto as Exhibit A and incorporated herein by reference.
- J. On November 17, 2020, the City Council of the City of Santa Ana held a duly noticed public hearing and voted to approve a resolution to adopt MND, ER No. 2018-83, and the related MMRP for the project.

Section 2. The City Council has independently reviewed and analyzed the information contained in the Initial Study and the MND, ER No. 2018-83, prepared with respect to this project. The City Council has, as a result of its consideration and the evidence presented at the hearings on this matter, determined that, as required pursuant to the CEQA and the State CEQA Guidelines, the MND adequately addresses the expected environmental impacts of this project. On the basis of this review, the City Council finds that there is no substantial evidence from which it can be fairly argued that the project will have a significant adverse effect on the environment.

Section 3. The City Council hereby adopts the MND, attached hereto as Exhibit A, and MMRP, attached hereto as Exhibit B, and directs that a Notice of Determination be prepared and filed with the County Clerk of the County of Orange in the manner required by law. This decision is based upon the evidence submitted at the above said hearing, which includes, but is not limited to: the Request for City Council Action dated November 17, 2020 and exhibits attached hereto; and the public testimony, written and oral, all of which are incorporated herein by this reference.

Section 4. Pursuant to Title XIV, California Code of Regulations (CCR) § 735.5(c)(1), the City Council has determined that, after considering the record as a whole, there is no evidence that the proposed project will have the potential for any significant adverse effect on wildlife resources or the ecological habitat upon which wildlife resources depend. The proposed project exists in an urban environment characterized by paved concrete, roadways, surrounding buildings and human activity. However, pursuant to Fish and Game Code § 711.2 and Title XIV, CCR § 735.5, the payment of Fish and Game Department filing fees in conjunction with this project is at the discretion of the State of California Department of Fish and Wildlife.

Section 5. The Applicant shall indemnify, protect, defend and hold the City and/or any of its officials, officers, employees, agents, departments, agencies, authorized volunteers, and instrumentalities thereof, harmless from any and all claims, demands, lawsuits, writs of mandamus, referendum, and other proceedings (whether legal, equitable, declaratory, administrative or adjudicatory in nature), and alternative dispute resolution procedures (including, but not limited to arbitrations, mediations, and such other procedures), judgments, orders, and decisions (collectively "Actions"), brought against the City and/or any of its officials, officers, employees, agents, departments, agencies, and instrumentalities thereof, that challenge, attack, or seek to modify, set aside, void, or annul, any action of, or any permit or approval issued by the City and/or any of its officials, officers, employees, agents, departments, agencies, and instrumentalities thereof (including actions approved by the voters of the City) for or concerning the project, whether such Actions are brought under the Ralph M. Brown Act, California Environmental Quality Act, the Planning and Zoning Law, the Subdivision Map Act, Code of Civil Procedure sections 1085 or 1094.5, or any other federal, state or local constitution, statute, law, ordinance, charter, rule, regulation, or any decision of a court of competent jurisdiction. It is expressly agreed that the City shall have the right to approve, which approval will not be unreasonably withheld, the legal counsel providing the City's defense, and that Applicant shall reimburse the City for any costs and expenses directly and necessarily incurred by the City in the course of the defense. City shall promptly notify the Applicant of any Action brought and City shall cooperate with Applicant in the defense of the Action.

Section 6. This decision rendered by the City Council of the City of Santa Ana is final and is subject to judicial review pursuant to California Code of Civil Procedure Section 1094.6. The Planning and Building Agency shall give direct notice to the Applicant of the City Council's decisions and these findings.

ADOPTED this \_\_\_\_ day of \_\_\_\_\_, 2020.

\_\_\_\_\_  
Miguel A. Pulido  
Mayor

APPROVED AS TO FORM:  
Sonia R. Carvalho  
City Attorney

By: \_\_\_\_\_  
Lisa Storck  
Assistant City Attorney

AYES: Councilmembers \_\_\_\_\_  
NOES: Councilmembers \_\_\_\_\_  
ABSTAIN: Councilmembers \_\_\_\_\_  
NOT PRESENT: Councilmembers \_\_\_\_\_

CERTIFICATE OF ATTESTATION AND ORIGINALITY

I, DAISY GOMEZ, Clerk of the Council, do hereby attest to and certify the attached Resolution No. 2020-xx to be the original resolution adopted by the City Council of the City of Santa Ana on \_\_\_\_\_.

Date: \_\_\_\_\_

\_\_\_\_\_  
Clerk of the Council  
City of Santa Ana

**EXHIBIT A**

**MITIGATED NEGATIVE DECLARATION**

The Mitigated Negative Declaration for the Project and Technical Studies are available online at:

<https://www.santa-ana.org/pb/planning-division/major-planning-projects-and-monthly-development-project-reports/mountain-view>

Or by visiting:

Planning and Building Agency – Planning Division Public Counter

20 Civic Center Plaza

Santa Ana, CA 92701

**EXHIBIT B**

**MITIGATION MONITORING AND REPORTING PROGRAM**

The following is a Mitigation Monitoring and Reporting Program (MMRP) for the Mountain View Avenue Condominiums located at 301 and 305 Mountain View Avenue, Santa Ana, CA. This MMRP has been prepared pursuant to Section 15097 of the California Environmental Quality Act (CEQA) Guidelines and Section 21081 of the Public Resources Code. The MMRP lists all applicable Project Mitigation Measures (MM) and environmental commitments that are required to be implemented with the Project under existing Standard Condition Plans, Programs, and Policies (SC) for implementing environmental resource protection legislation. This MMRP includes implementation timing and responsible party to ensure proper enforcement of all MM and SC to reduce Project impacts. The City of Santa Ana, as the Lead Agency, will utilize the MMRP to document the implementation of Project mitigation and SC environmental commitments, which ensure all project impacts are reduced to less than significance pursuant to the CEQA.

<b>Mitigation Number</b>	<b>Mitigation Measure</b>	<b>Responsible Party</b>	<b>Timing</b>	<b>Date Completed and Initials</b>
<b>AESTHETICS</b>				
MM AES-1	<p>The Contractor shall partition active areas of construction, stockpiles and materials storage locations; and, shall perform all work with downlighting and installation of a barrier to confine construction-related light and glare into active construction zones and to minimize spillover light and glare from construction equipment onto adjacent areas by implementing the following:</p> <p>(a) A temporary barrier between nearby residences and areas of active construction will be placed.</p> <p>(b) Temporary security lighting must be low voltage and downlit.</p>	Contractor and City Inspector	During all phases of construction	
<b>AIR QUALITY</b>				
MM AQ-1	Emissions controls and fugitive dust emissions controls will be implemented to reduce airborne dust contributing to PM10 and PM2.5 pursuant to SXAQMD Rules 403 for PM and PM2.5 and pursuant to Rule 1466 pertaining to toxic	Contractor as verified by City Planner and City Engineer, construction	During all phases of construction	

	<p>air contaminants. This includes dust control BACM and air quality TAC monitoring for Lead:</p> <ul style="list-style-type: none"> <li>(a) Designate a Dust Control Supervisor;</li> <li>(b) Provide PM10 monitoring both upwind and downwind during earth-moving activities;</li> <li>(c) Maintain records of earth-moving activities, monitoring, instrument calibration, manifest records for transport, volumes of materials with TAC, distances to a residence, park or school, and complaints;</li> <li>(d) Install minimum 6-foot tall barrier fencing where earth moving activities are carried out, and fencing at least as high as stockpiles;</li> <li>(e) Apply water or other soils stabilizers prior to earthmoving activities and maintain moisture content to prevent generation of visible dust plumes;</li> <li>(f) Post signs limiting speed limit to 15 miles per hour;</li> <li>(g) Stabilize or cover disturbed surfaces and apply stabilizers and cover haul loads prior to unloading;</li> <li>(h) Remove track-out with a vacuum equipped with filters rated to achieve 99.97% capture efficiency for 0.3 micron particles;</li> <li>(i) Prevent track-out and clean soils from the exterior of trucks, trailers and tires prior to leaving the Project Area;</li> </ul>	staff		
--	---	-------	--	--

	<ul style="list-style-type: none"> <li>(j) Segregate and label TAC stock piles and apply stabilizers, and 10mm plastic overlapping and anchored sheeting;</li> <li>(k) Cease activities during high winds (15 miles per hour over a 15-minute period or instantaneous wind speeds exceeding 25 MPH); and</li> <li>(l) Proper notification of SCAQMD prior to earthmoving</li> </ul>			
MM AQ-2	<p>Construction emissions will be reduced according to the following:</p> <ul style="list-style-type: none"> <li>(a) Disturbed areas will be stabilized at the end of each day with trench plates or similar devices.</li> <li>(b) Idling on construction equipment and vehicles will be limited to 5 minutes;</li> <li>(c) The project will implement Tier IV mitigation to reduce exhaust from diesel powered engines in compliance with AQMD;</li> <li>(d) The project will implement Tier III engines; and</li> <li>(e) Construction staff will carpool.</li> </ul>	Contractor as verified by City Planner and City Engineer, construction staff	During all phases of construction	
MM AQ-3	Project plans and specifications shall incorporate a temporary signage plan for the Project, which shall be verified by the City Engineer, and shall include a feedback phone number. The Contractor shall post Project Area will be with a phone number intended for 24/7 feedback to the Contractor and City from the community according to approved plans.	City Engineer, Contractor and City Inspector	During all phases of construction	

**BIOLOGY**

<p>SC BIO-1</p>	<p>Plans and specifications for the project shall include the following note prior to issuance of permits to reduce impacts from vegetation trimming and clearing, tree trimming and removals, generation of mechanical noise or ground disturbance on active bird nests from native nesting birds: Active avian nests shall be avoided by the contractor by scheduling these construction activities outside of the avian breeding season, which is typically during February 1 to September 1.</p>	<p>Project proponent as verified by City Planner and Contractor as verified by City inspector.</p>	<p>Prior to issuance of permits during avian breeding season, Feb 1 – Sept 1 and verified throughout construction stages</p>	
<p>SC BIO-2</p>	<p>Plans and specifications for the project shall include the following note prior to issuance of permits to reduce impacts on nesting birds prior to commencement of work during the typical nesting season, the contractor shall hire a qualified biologist to conduct a nest survey, within the project boundaries and within a 1,000-foot radius buffer, three days in advance of the start of construction (for work beginning approximately between February 1 and September 1). This survey for bird nests will report the location of nesting birds that could be impacted by the project for species covered under the Migratory Bird Treaty Act and Fish and Game Code sections 3503, 3503.5, and 3513.</p>	<p>Project proponent as verified by the City Planner and Contractor as verified by City inspector, Project Biologist, Arborist</p>	<p>Prior to issuance of permits during avian breeding season, Feb 1 – Sept 1 and verified throughout construction stages</p>	
<p>SC BIO-3</p>	<p>Plans and specifications for the project shall include the following note prior to issuance of permits to reduce impacts on birds If active nests are found, the biologist will be retained for construction monitoring and to coordinate with CDFW on establishing specific buffers around nests that are sufficient to ensure that breeding is not likely to be disrupted or adversely impacted by construction pursuant to CDFW requirements. Buffers around active nests will be established pursuant to CDFW protocol or determination by a qualified CDFW biologist for smaller buffers which are sufficient to avoid impacts to nesting birds. Buffers will be maintained until young have fledged or the nests become inactive. Factors for consideration on nest buffers will include:</p>	<p>Project proponent as verified by the City Planner and Contractor as verified by City inspector, Project Biologist, Arborist</p>	<p>Prior to issuance of permits during avian breeding season, Feb 1 – Sept 1 and verified throughout construction stages</p>	



	<p>(a) The presence of natural buffers provided by vegetation or topography;</p> <p>(b) nest height; and</p> <p>(c) locations of foraging territory; and baseline levels of noise and human activity.</p>			
<b>CULTURAL RESOURCES</b>				
SC CUL-1	Plans and specifications for the project shall include the following note prior to issuance of permits: If human remains are found, work in the location of the remains would cease and the Orange County Coroner's office would be contacted pursuant to Health and Safety Code Section 7050.5 to identify the appropriate next steps. If Native American remains are found, the most likely descendent would be notified pursuant to Section 5097.94 of the Public Resources Code.	Project proponent as verified by City Planner and Contractor as verified by City Inspector	Prior to issuance of permits and during construction	
<b>GEOLOGY AND SOILS</b>				
MM GEO-1	<p>Structural foundations preparation methods for foundations shall be incorporated into project specifications and plans and reviewed and approved by the Soils Engineer and Geotechnical Engineer for the project prior to issuance of a grading and building permits. Plans and Specifications shall include:</p> <p>(a) A minimum 3-foot compacted fill blanket below the bottom of footings or per the geologist recommendations based on final plans shall be implemented. For other minor structures like property line walls or retaining walls less than 4 feet high, competent native soils or compacted fill may be used;</p> <p>(b) Earthwork for foundation support shall include the entire building pad and shall extend a minimum of 5 feet outside exterior footing lines;</p>	Project proponent as verified by the City Engineer and Building Official	During Plan Check prior to issuance of permits and ongoing during Construction Inspection	

	<p>(c) Footing bottoms shall be observed by the geotechnical engineer to verify competent conditions;</p> <p>(d) Continuous spread footings placed a minimum depth of 24 inches below lowest adjacent finished grade may be used for the structures, with footing reinforcement with a minimum of two No. 4 bars (1 top and 1 bottom) and shall be observed by the geotechnical engineer to verify competent soil conditions; and</p> <p>(e) If a slab on grade is utilized, the slab shall be supported on engineered fill compacted to a minimum of 90 percent relative compaction. Slabs should be reinforced with at least No. 3 bars 18 inches on center both ways.</p>			
MM GEO-2	<p>Foundation plans and specifications shall be reviewed and approved by the Geologist and the Soil Engineer and shall incorporate the recommendations of the Geologist and Soil Engineer subgrade preparation prior to issuance of grading permits including the following measures:</p> <p>(a) The soil should be kept moist prior to casting the slab, and if the soils at grade become disturbed during construction, they should be brought to approximately optimum moisture content, and rolled to a firm, unyielding condition prior to placing concrete.</p> <p>(b) In areas where a moisture sensitive floor covering will be used, a vapor barrier consisting of a plastic film (6 ml polyvinyl chloride or</p>	Project proponent as verified by the City Engineer and Building Official	During Plan Check prior to issuance of permits and during Construction Inspection	

	<p>equivalent) should be used. The vapor barrier should be properly lapped and sealed.</p> <p>(c) Hardscape and slab subgrade areas shall exhibit a minimum of 90 percent relative compaction to a depth of at least 1 foot. Deeper removal and re-compaction may be required if unacceptable conditions are encountered. These areas require testing for compaction just prior to placing concrete.</p> <p>(d) Site grading shall incorporate drainage directed away from structures via non-erodible conduits to detention areas. The structure should utilize roof gutters and down spouts tied directly to yard drainage.</p> <p>(e) Unlined flower beds, planters, and lawns should not be constructed against the perimeter of the structure. If such landscaping (against the perimeter of a structure) is planned, it should be properly drained and lined or provided with an underground moisture barrier and irrigation in these areas should be kept to a minimum.</p>			
MM GEO-3	<p>Grading plans and specifications for the project shall be reviewed and approved by the Soil and Geotechnical Engineers and shall include the recommendations of the Soil Engineer and Geotechnical Engineer including the following:</p> <p>(a) After the foundation for the fill has been cleared, plowed or scarified, it shall be disced or bladed until it is uniform and free from large clods, brought to a proper moisture content and compacted to not</p>	Project proponent as verified by City Engineer	During Plan Check and Construction Inspections	

	less than 90 percent of the maximum dry density in accordance with ASTM:D-1557 (5 layers -25 blows per layer; 10 lb. hammer dropped 18"; 4" diameter mold).			
MM GEO-4	<p><b>MM GEO – 4:</b> The Soil Engineer shall provide continuous supervision of the site clearing and grading operation so that he can verify the grading was done in accordance with the accepted plans and specifications including the following provisions a through w:</p> <ul style="list-style-type: none"> <li>a) All grading shall consist of removal and re-compaction of soft surficial soils.</li> <li>b) All existing vegetation shall be stripped and hauled from the site.</li> <li>c) On-site materials may be used for fill, or fill materials shall consist of materials approved by the Soils Engineer and may be obtained from the excavation of banks, borrow pits or any other approved source. The materials used should be free of vegetable matter and other deleterious substances and shall not contain rocks or lumps greater than 8 inches in maximum dimension.</li> <li>d) The selected fill material shall be placed in layers which, when compacted, shall not exceed 6 inches in thickness. Each layer shall be spread evenly and shall be thoroughly mixed during the spreading to ensure uniformity of material and moisture of each layer.</li> <li>e) No fill material shall be placed, spread or rolled during unfavorable weather conditions.</li> </ul>	Contractor as verified by City Building Official/ Inspector	Ongoing During Construction	

	<p>f) When work is interrupted by heavy rains, fill operations shall not be resumed until the field tests by the Soils Engineer indicate the moisture content and density of the fill are as previously specified.</p> <p>g) Where moisture of the fill material is below the limits specified by the Soils Engineer, water shall be added until the moisture content is as required to ensure thorough bonding and thorough compaction.</p> <p>h) Where moisture content of the fill material is above the limits specified by the Soils Engineer, the fill materials shall be aerated by blading or other satisfactory methods until the moisture content is as specified by the Soils Engineer.</p> <p>i) After each layer has been placed, mixed and spread evenly, it shall be thoroughly compacted to not less than 90 percent of the maximum dry density in accordance with ASTM:D-1557 (5 layers -25 blows per layer; 10 lbs. hammer dropped 18 inches; 4" diameter mold) or other density tests which will attain equivalent results.</p> <p>j) Compaction shall be by sheepsfoot roller, multi-wheel pneumatic tire roller or other types of acceptable rollers.</p> <p>k) Rollers shall be of such design that they will be able to compact the fill to the</p>			
--	--	--	--	--

	<p>specified density. Rolling shall be accomplished while the fill material is at the specified moisture content.</p> <ul style="list-style-type: none"> <li>l) Rolling of each layer shall be continuous over the entire area and the roller shall make sufficient trips to ensure that the desired density has been obtained. The final surface of the lot areas to receive slabs on grade should be rolled to a dense, smooth surface.</li> <li>m) The outside of all fill slopes shall be compacted by means of sheepsfoot rollers or other suitable equipment.</li> <li>n) Compaction operations shall be continued until the outer 9 inches of the slope is at least 90 percent compacted. Compacting of the slopes may be progressively in increments of 3 feet to 5 feet of fill height as the fill is brought to grade, or after the fill is brought to its total height.</li> <li>o) Field density tests shall be made by the Soils Engineer of the compaction of each layer of fill.</li> <li>p) Density tests shall be made at intervals not to exceed 2 feet of fill height provided all layers are tested.</li> <li>q) Where the sheepsfoot rollers are used, the soil may be disturbed to a depth of several inches and density readings shall be taken in the compacted material below the disturbed surface.</li> <li>r) When these readings indicate that the density of any layer of fill or portion there is</li> </ul>			
--	---	--	--	--

	<p>below the required 90 percent density, the particular layer or portion shall be reworked until the required density has been obtained.</p> <ul style="list-style-type: none"> <li>s) Removal and re-compaction of existing fill and loose native soils will be required to provide adequate support for foundations and slabs on grade.</li> <li>t) Removals shall extend downward into competent earth materials or to at least 2 feet below proposed footing bottoms, whichever is deeper.</li> <li>u) The exposed excavation bottom shall be observed and approved by the Geotechnical Engineer. Subsequent to approval of the excavation bottom, the area shall be scarified 6 inches, moisture conditioned as needed, and compacted to a minimum of 90 percent relative compaction.</li> <li>v) Fill soils shall be placed in 6 to 8-inch loose lifts, moisture conditioned as needed, and compacted to a minimum of 90 percent relative compaction up to finish grade.</li> <li>w) All utility line backfills, both interior and exterior, shall consist of clean sand and gravel, and be compacted to a minimum of 90 percent relative compaction and shall require testing at a maximum of 2-foot vertical intervals.</li> </ul>			
MM GEO-5	In the event that buried paleontological resources or geologic features are encountered during grading, work in the	Contractor and Building Official/	Ongoing during Construction	

	area of the find shall cease and a qualified paleontologist or geologist shall inspect the resources and determine the appropriate course of action for further treatment.	Inspector		
<b>HYDROLOGY AND WATER QUALITY</b>				
SC HYD-1	<p>Prior to issuance of building and grading permits, structural BMPs shall be incorporated into the final development plans and specifications for the project and prior to final tract map approval, non-structural BMPs shall be incorporated into CC&amp;Rs for Condominium Tract 19064 including but not limited to the following:</p> <ul style="list-style-type: none"> <li>a) Permeable driveway paving system with filtered storm drain inlets designed to detain 80 percent of 100-year storm flows from the APN 100-281-05 shall be incorporated into project plans and specifications and maintained through the HOA and CC&amp;Rs.</li> <li>b) Pet Waste Stations including bags and covered receptacle shall be incorporated into project plans and funded/maintained through the HOA and CC&amp;Rs.</li> <li>c) Covered trash receptacles shall be included in the common area on the final plans and maintained by the HOA through CC&amp;Rs.</li> <li>d) Owner education materials, including proper handling, storage and disposal of toxics and maintenance of yard drains shall be incorporated into CC&amp;Rs for the tract.</li> </ul>	Project Proponent as verified by the City Engineer and Building Official/ Inspector	During Plan Check and Ongoing During Construction	
SC HYD-2	Prior to issuance of permits for the project, water efficient landscaping and irrigation details shall be incorporated into development plans and specifications for the project.	Project Proponent as verified by the City Engineer and	During Plan Check and Ongoing During Construction	



		Building Official/Inspector		
SC HYD-3	<p>Prior to issuance of grading and building permits, erosion control measures shall be included in final plans and specifications including but not limited to provisions a-d below:</p> <ul style="list-style-type: none"> <li>a) Twice daily minimum sweeping of track-out areas.</li> <li>b) Cover haul loads and stockpiles with tarps.</li> <li>c) Maintain adequate soil moisture in disturbed surfaces during and after grading.</li> <li>d) Reduce construction vehicle speeds and idling times.</li> </ul>	Project Proponent as verified by the City Engineer and Building Official/Inspector	During Plan Check and Ongoing During Construction	
<b>NOISE</b>				
MM NOI-1	<p>Final plans and specifications for the project shall include a note as follows: During demolition and construction, the contractor shall install noise source reduction or noise barriers and shall measure the effectiveness of said noise mitigation to document that project construction does not exceed the FTA threshold of 80 dB at nearby residential land uses. Said noise mitigation shall include but not be limited to the following:</p> <ul style="list-style-type: none"> <li>a) Shall fit equipment at the project site mufflers providing at least 8 dB of noise reduction, or</li> <li>b) Shall construct temporary enclosures or acoustical tents that provide at least 8 dB of noise; and</li> <li>c) Shall measure and document the effectiveness of the implemented noise abatement measures</li> </ul>	Project Proponent as verified by the Building Official and Building Inspector	During Plan Check and Ongoing During Construction	
<b>TRIBAL CULTURAL RESOURCES</b>				

MM TRI-1	<p>Prior to the issuance of any permits for initial site clearing (such as pavement removal, grubbing, tree removals) or issuance of permits allowing ground disturbing activities that cause excavation to depths greater than artificial fill (including as boring, grading, excavation, drilling, potholing or auguring, and trenching), the City of Santa Ana shall ensure that the project applicant/developer retain qualified Native American Monitor(s). The monitor(s) shall be approved by the tribal representatives of the Gabrieleno Band of Mission Indians - Kizh Nation and be present on-site during initial site clearing and construction that involves ground disturbing activities that cause excavation to depths greater than artificial fill identified herein. The monitor shall conduct a Native American Indian Sensitivity Training for construction personnel. The training session includes a handout and focus on how to identify Native American resources encountered during earthmoving activities and the procedures followed if resources are discovered. The Native American monitor(s) shall complete monitoring logs on a daily basis, providing descriptions of the daily activities, including construction activities, locations, soil, and any cultural materials identified. The on-site monitoring shall end when grading and excavation activities of native soil (i.e., previously undisturbed) are completed, or when the tribal representatives and monitor have indicated that the site has a low potential for tribal cultural resources, whichever occurs first.</p>	City Building Official and City Planning Department	During Plan Check prior to issuance of permits and ongoing during construction	
MM TRI-2	<p>In the event that tribal cultural resources are inadvertently discovered during ground disturbing activities, work must be halted within 50 feet of the find until it can be evaluated by a qualified archaeologist in cooperation with a Native American monitor to determine if the potential resource meets the CEQA definition of historical (State CEQA Guidelines 15064.5(a)) and/or</p>	Official and City Planning Department	Check prior to issuance of permits and ongoing during construction	

	<p>unique resource (Public Resources Code 21083.2(g)). Construction activities could continue in other areas. If the find is considered an "archeological resource" the archaeologist, in cooperation with a Native American monitor shall pursue either protection in place or recovery, salvage and treatment of the deposits. Recovery, salvage and treatment protocols shall be developed in accordance with applicable provisions of Public Resource Code Section 21083.2 and State CEQA Guidelines 15064.5 and 15126.4. If unique a tribal cultural resource cannot be preserved in place or left in an undisturbed state, recovery, salvage and treatment shall be required at the Project applicant's expense. All recovered and salvaged resources shall be prepared to the point of identification and permanent preservation in an established accredited professional repository.</p>			
--	---	--	--	--

# **EXHIBIT 4**

## RESOLUTION NO. 2020-xx

A RESOLUTION OF THE CITY COUNCIL OF THE CITY OF SANTA ANA APPROVING GENERAL PLAN AMENDMENT NO. 2020-04 TO CHANGE THE GENERAL PLAN LAND USE DESIGNATIONS FOR THE PROPERTIES LOCATED AT 4310, 4314, 4318, 4322, 4326 AND 4330 WEST FIFTH STREET, 113, 117, 121, 201, 203, 207, 211, 221, 223, 225, 227, 229, 231, 233, 235, 237, 239, 241, 243, 245, 247, 301, 305, 321, 323, 325, 327, 329, 331, 333, 335, 337, 339, 341, 343, 345, 347, 349, 351, 353, 355, 357, 359, 361, 363, 365, 409 AND 411 NORTH MOUNTAIN VIEW STREET, AND 4311, 4315, 4317, 4319, 4321, 4323, 4325, 4327, 4329, 4331, 4333, 4335, 4337, AND 4339 WEST FIRST STREET

BE IT RESOLVED BY THE CITY COUNCIL OF THE CITY OF SANTA ANA AS FOLLOWS:

Section 1. The City Council of the City of Santa Ana hereby finds, determines and declares as follows:

- A. Steve Jones with Olympia Capital Corporation, representing Mountain View Real Estate Investments, LLC. ("Applicant") is requesting approval of General Plan Amendment (GPA) No. 2020-04 to amend the General Plan land use designation of the properties located at 301 and 305 North Mountain View Street from Low Medium Density Residential (LMR-11) to Medium Density Residential (MR-15) and to update text portions of the City's Land Use Element to reflect this change in order to facilitate construction of an 8-unit condominium development.
- B. In addition, the City of Santa Ana is proposing to change the land use designation of the properties located at 4310, 4314, 4318, 4322, 4326 and 4330 West Fifth Street, 113, 117, 121, 201, 203, 207 and 211 North Mountain View Street from LMR-11 to Low Density Residential (LR-7); 221, 223, 225, 227, 229, 231, 233, 235, 237, 239, 241, 243, 245, 247, 301, 305, 321, 323, 325, 327, 329, 331, 333, 335, 337, 339, 341, 343, 345, 347, 349, 351, 353, 355, 357, 359, 361, 363, 365, 409 and 411 North Mountain View Street and 4311 West First Street from LMR-11 to MR-15; and 4315, 4317, 4319, 4321, 4323, 4325, 4327, 4329, 4331, 4333, 4335, 4337 and 4339 West First Street from General Commercial (GC) to MR-25.
- C. On October 26, 2020, the Planning Commission of the City of Santa Ana held a duly noticed public hearing and voted to recommend that the City Council adopt a resolution approving GPA No. 2020-04.

- D. On November 17, 2020, the City Council of the City of Santa Ana held a duly noticed public hearing to consider all testimony, written and oral, related to GPA No. 2020-04, at which time all persons wishing to testify were heard, the project was fully considered, and all other legal prerequisites to the adoption of this resolution occurred.

Section 2. The General Plan Amendment consists of amendments to the Land Use Element and text updates, as shown in Exhibit A, attached hereto and incorporated herein by reference.

Section 3. The City Council hereby finds that the proposed General Plan Amendment is compatible with the objectives, policies, and general plan land use programs specified in the General Plan for the City of Santa Ana in that:

- A. The City of Santa Ana has officially adopted a General Plan.
- B. The land uses authorized by the General Plan Amendment, and the General Plan Amendment itself, are compatible with the objectives, policies, general land uses, and programs specified in the General Plan, for the following reasons:
- i. The proposed General Plan land use designation for the project area is MR-15, which applies to multiple-family developments characterized by duplexes, apartments, and townhomes with a maximum allowable intensity of 15 dwelling units per acre. This change is consistent with Table A-3 (Correlation of Land Use Designation and Zoning Districts) of the General Plan Land Use Element.
  - ii. The subject project site and the surrounding properties on the east side of Mountain View Street have a LMR-11 or General Commercial (GC) land use designations, however, the properties are developed with residential uses, with numerous properties currently exceeding the maximum allowed density permitted in the LMR-11 land use designation. The densities surrounding this area range from 4.8 to 18.8 dwelling units per acre. Changing the land use designations will bring the General Plan Land Use Plan into close consistency with existing residential development density and characteristics in the area and will allow for consistent development intensity for future projects.
  - iii. The general plan amendment will support several goals and policies of the General Plan, including the Land Use Element and Housing Element. Specifically, the project will be consistent with Land Use Element, Goal 1 to promote a balance of land uses to address basic community needs. Policy 1.5 states a desire maintain and foster a variety of residential land uses. The project will provide eight for-sale condominium units. Policy 2.10 supports new development which is harmonious in scale and character with existing

development in the area. The project is similar in scale and character to the adjacent multi-family uses. Policy 3.1 supports development which provides a positive contribution to neighborhood character and identity. The project will allow for redevelopment of an underutilized lot with a new residential development with a contemporary design and variety of building materials. Housing Element, Goal 2 encourages a diversity of quality housing, affordability levels, and living experiences that accommodate Santa Ana's residents and workforce of all household types, income levels, and are groups to foster an inclusive community. Policy 2.5 facilitates diverse types, prices and size of housing, including single-family homes, apartments, townhomes, mixed/multiuse housing, transit oriented housing, multi-generational housing and live work opportunities. The project will provide a for-sale condominium product with units that range in size that are targeted to entry level home ownership.

Section 4. The GPA will not adversely affect the public health, safety, and welfare in that the GPA will not result in incompatible land uses on adjacent properties, inconsistencies with any General Plan goals or policies, or adverse impacts to the environment.

Section 5. The City Council of the City of Santa Ana after conducting the public hearing hereby approves GPA No. 2020-04. The amendments to the Land Use Element are attached hereto as Exhibit A and incorporated herein by this reference as though fully set forth herein. This decision is based upon the evidence submitted at the above said hearing, which includes, but is not limited to: the Request for Planning Commission Action dated October 26, 2020, the Request for Council Action dated November 17, 2020, and exhibits attached hereto; and the public testimony, written and oral, all of which are incorporated herein by this reference.

Section 6. The City Council approves GPA No. 2020-04 as set forth in Exhibit A, attached hereto and incorporated herein by reference, subject to compliance with the Mitigation Monitoring and Reporting Program, and upon satisfaction of the conditions set forth below:

- A. Subject to compliance with the Mitigation Monitoring and Reporting Program, the Land Use Element map and text shall be amended to read as set forth in Exhibit A, attached hereto and incorporated herein by reference.
- B. The General Plan Amendment shall not take effect unless and until Mitigated Negative Declaration (MND) and Mitigation Monitoring and Reporting Program (MMRP), Environmental Review No. 2018-83 and Amendment Application (AA) No. 2020-02 are adopted by the City Council.

Section 7. The Applicant shall indemnify, protect, defend and hold the City and/or any of its officials, officers, employees, agents, departments, agencies, authorized volunteers, and instrumentalities thereof, harmless from any and all claims, demands, lawsuits, writs of mandamus, referendum, and other proceedings (whether legal, equitable, declaratory, administrative or adjudicatory in nature), and alternative dispute resolution procedures (including, but not limited to arbitrations, mediations, and such other procedures), judgments, orders, and decisions (collectively "Actions"), brought against the City and/or any of its officials, officers, employees, agents, departments, agencies, and instrumentalities thereof, that challenge, attack, or seek to modify, set aside, void, or annul, any action of, or any permit or approval issued by the City and/or any of its officials, officers, employees, agents, departments, agencies, and instrumentalities thereof (including actions approved by the voters of the City) for or concerning the project, whether such Actions are brought under the Ralph M. Brown Act, California Environmental Quality Act, the Planning and Zoning Law, the Subdivision Map Act, Code of Civil Procedure sections 1085 or 1094.5, or any other federal, state or local constitution, statute, law, ordinance, charter, rule, regulation, or any decision of a court of competent jurisdiction. It is expressly agreed that the City shall have the right to approve, which approval will not be unreasonably withheld, the legal counsel providing the City's defense, and that Applicant shall reimburse the City for any costs and expenses directly and necessarily incurred by the City in the course of the defense. City shall promptly notify the Applicant of any Action brought and City shall cooperate with Applicant in the defense of the Action.

Section 8. This decision rendered by the City Council of the City of Santa Ana is final and is subject to judicial review pursuant to California Code of Civil Procedure section 1094.6. The Planning and Building Agency shall give direct notice to the Applicant of the City Council's decisions and these findings.

ADOPTED this \_\_\_\_ day of \_\_\_\_\_, 2020.

\_\_\_\_\_  
Miguel A. Pulido  
Mayor

APPROVED AS TO FORM:  
Sonia R. Carvalho  
City Attorney

By: \_\_\_\_\_  
Lisa Storck  
Assistant City Attorney



AYES: Councilmembers \_\_\_\_\_

NOES: Councilmembers \_\_\_\_\_

ABSTAIN: Councilmembers \_\_\_\_\_

NOT PRESENT: Councilmembers \_\_\_\_\_

CERTIFICATE OF ATTESTATION AND ORIGINALITY

I, DAISY GOMEZ, Clerk of the Council, do hereby attest to and certify the attached Resolution No. 2020-xx to be the original resolution adopted by the City Council of the City of Santa Ana on \_\_\_\_\_.

Date: \_\_\_\_\_

\_\_\_\_\_  
Clerk of the Council  
City of Santa Ana

# City of Santa Ana General Plan Land Use Element 1998

## City of Santa Ana Planning Division



Adopted

**February 2, 1998**

(Reformatted January 2010)

The following is a chronology of the approved general plan amendments that have been incorporated into this document since the comprehensive update of the General Plan Land Use Element adopted by the Santa Ana City Council February 2, 1998 (GPA 1997-05):


[GPA 2020-04 \(Pending\)](#)

GPA 2020-03 (September 1, 2020)  
GPA 2020-01 (April 21, 2020)  
GPA 2018-04 (December 31, 2019)  
GPA 2019-02 (October 1, 2019)  
GPA 2019-01 (June 4, 2019)  
GPA 2017-03 (June 4, 2019)  
GPA 2018-05 (December 4, 2018)  
GPA 2018-03 (September 18, 2018)  
GPA 2018-02 (May 15, 2018)  
GPA 2015-01 (May 15, 2018)

GPA 2017-02 (December 19, 2017)  
GPA 2017-01 (June 20, 2017)  
GPA 2016-03 (February 21, 2017)  
GPA 2016-02 (May 17, 2016)  
GPA 2016-01 (April 19, 2016)  
GPA 2015-03 (February 2, 2016)  
GPA 2014-02 (October 21, 2014)  
GPA 2014-01 (June 3, 2014)  
GPA 2011-03 (March 19, 2012)  
GPA 2011-02 (June 6, 2011)  
GPA 2010-01 (June 7, 2010)  
GPA 2008-02 (July 20, 2009)  
GPA 2007-03 (May 18, 2009)

GPA 2004-03 (February 2, 2009)  
GPA 2008-01 (May 5, 2008)  
GPA 2007-02 (June 18, 2007)  
GPA 2007-01 (March 19, 2007)  
GPA 2006-01 (October 2, 2006)  
GPA 2005-01 (December 5, 2005)  
GPA 2005-02 (October 17, 2005)  
GPA 2004-01 (April 5, 2005, as passed by the voters of Santa Ana)  
GPA 2004-04 (July 19, 2004)  
GPA 2004-06 (July 6, 2004)  
GPA 2008-02 (July 20, 2009)  
GPA 2003-02 (June 16, 2003)  
GPA 2003-01 (February 18, 2003)

GPA 2002-01 (September 3, 2002)  
GPA 2002-03 (August 19, 2002)  
GPA 2001-03 (February 19, 2002)  
GPA 2001-02 (January 7, 2002)  
GPA 2000-09 (May 7, 2001)  
GPA 2000-08 (February 5, 2001)  
GPA 2000-03 (December 4, 2000)  
GPA 2000-02 (November 20, 2000)  
GPA 1999-02 (October 18, 1999)  
GPA 1999-01 (August 16, 1999)  
GPA 1998-04 (October 5, 1998)  
GPA 1998-05 (September 21, 1998)  
GPA 1998-01 (May 4, 1998)




### Land Use Designations

- LR-7 (Low Density Residential)
- LMR-11 (Low-Medium Density Residential)
- MR-15 (Medium Density Residential)
- UN (Urban Neighborhood)
- GC (General Commercial)
- IND (Industrial)
- INS (Institutional)
- O (Open Space)
- DC (District Center)
- PAO (Professional & Administration Office)
- OBPOC (One Broadway Plaza District Ctr.)

## Land Use Plan

Pending - November 2020



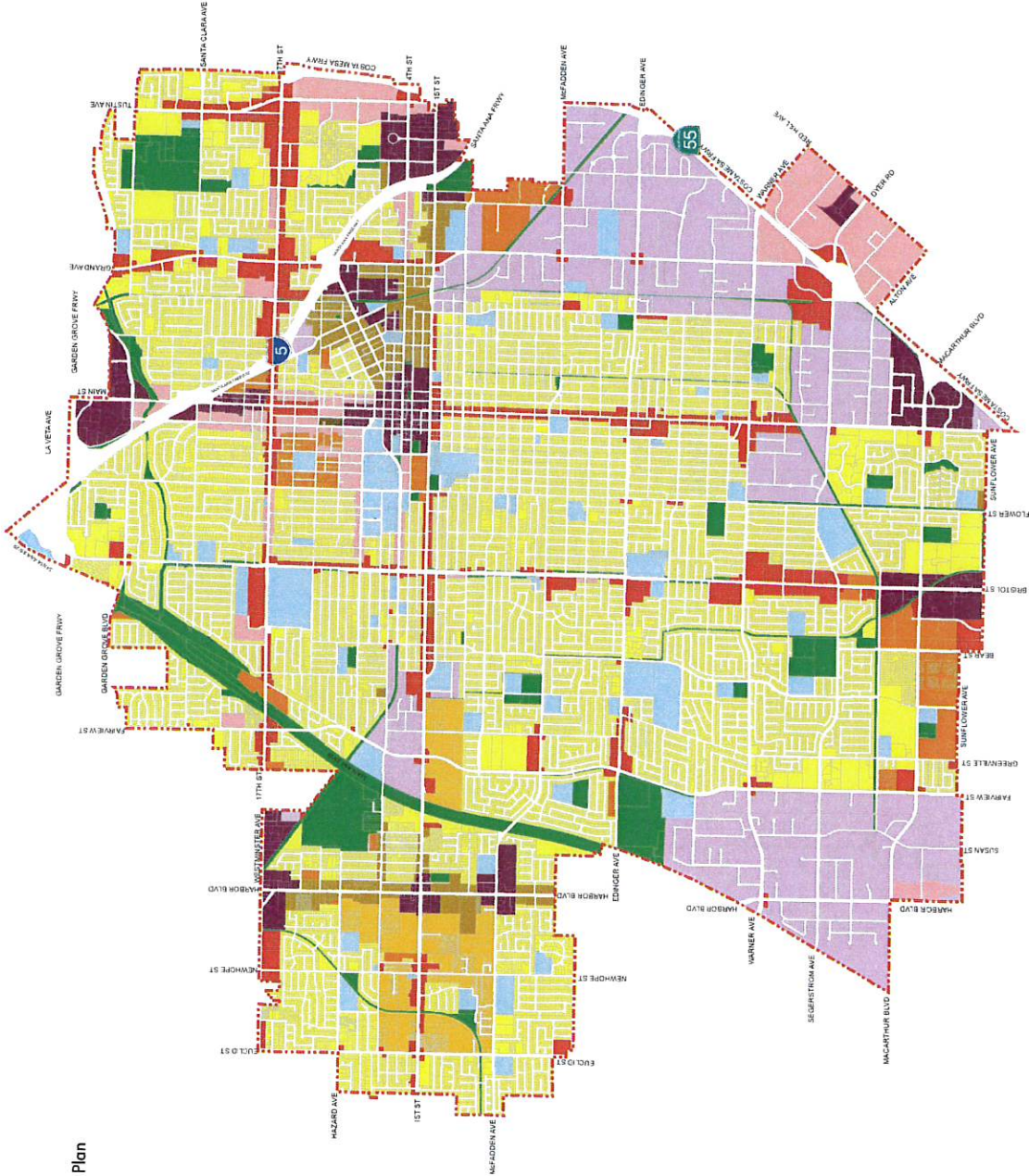



Exhibit 2 Land Use Plan

Exhibit A-4 Land Use Plan & Development Intensity Standards/FAR

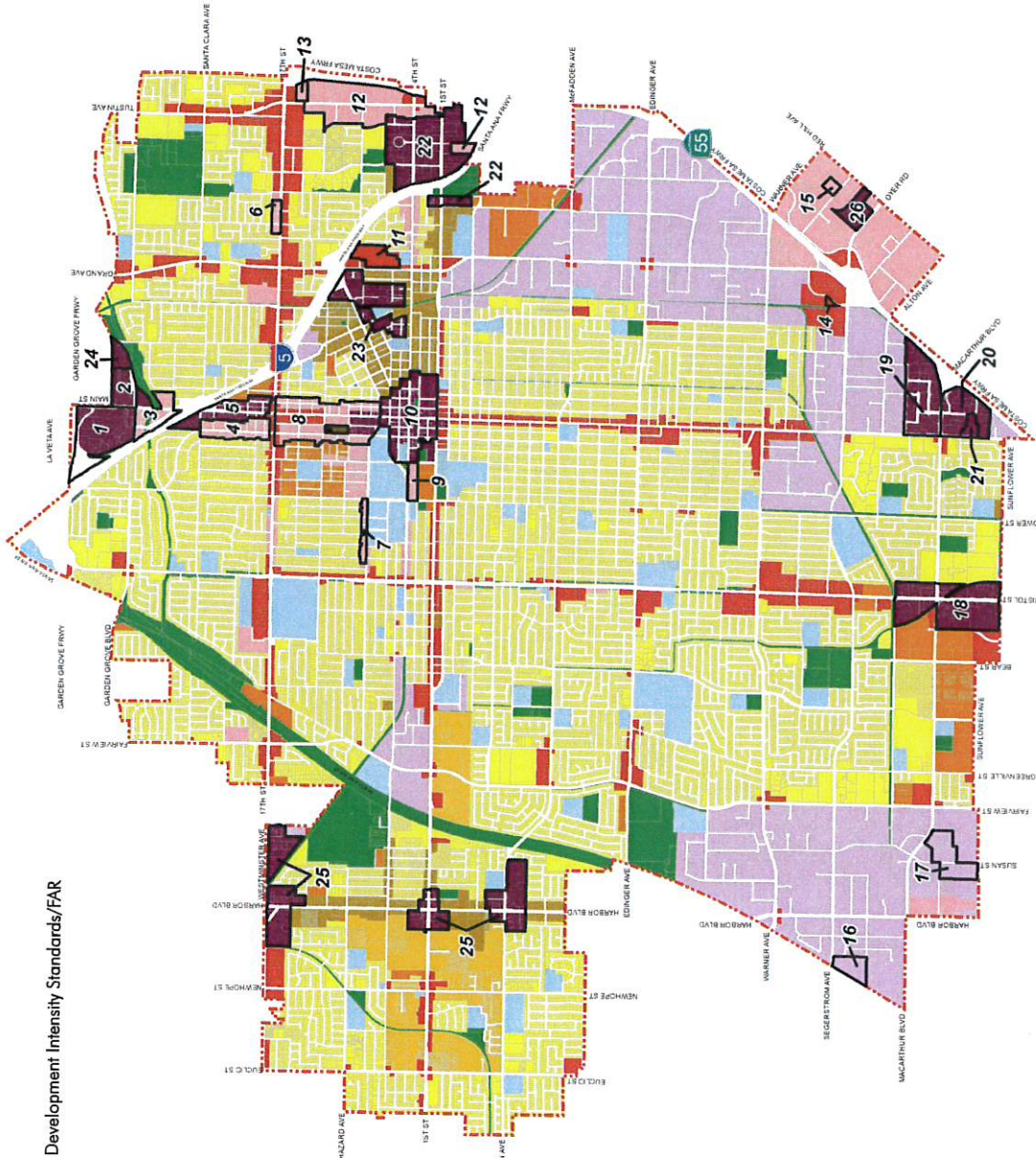


These land use designations have a floor area ratio as noted. Where a ratio difference is indicated in the table below.


DC (District Center)	1.0
UN (Urban Neighborhood)	0.5 - 1.5
PAO (Professional & Administration Office)	0.5
OBPDC (One Broadway Plaza District Ctr.)	2.9
GC (General Commercial)	0.5
IND (Industrial)	0.45
INS (Institutional)	0.5
O (Open Space)	0.2

Project / Area	Floor Area Ratio
1. Main Plaza	2.1
2. North Main St.	1.5
3. North Broadway	1.0
4. North Broadway	1.0
5. Historic Development	1.0
6. Historic Development	1.0
7. Civic Center Specific Dev. Plan	1.0
8. Civic Center Specific Dev. Plan	0.5-1.0
9. Downtown	3.0
10. Downtown	3.0
11. Orange County Register	1.5
12. Bentall Center Dev.	1.5
13. Bentall Center Dev.	1.5
14. 2720 Heald Terrace Dr.	1.0
15. 4240 W. Carnegie Ave.	0.47
16. Lake Center Dev.	0.72
17. Lake Center Dev.	2.0
18. MacArthur Place	1.0
19. MacArthur Place South	1.0
20. MacArthur Place	3.0
21. MacArthur Place	3.0
22. Transit Village	5.0
23. Transit Village	5.0
24. Harbor-Mixed Use Specific Plan	0.5-5.0
25. The Heritage	1.7


LR-7 (Low Density Residential)



LMR-11 (Low-Medium Density Residential)



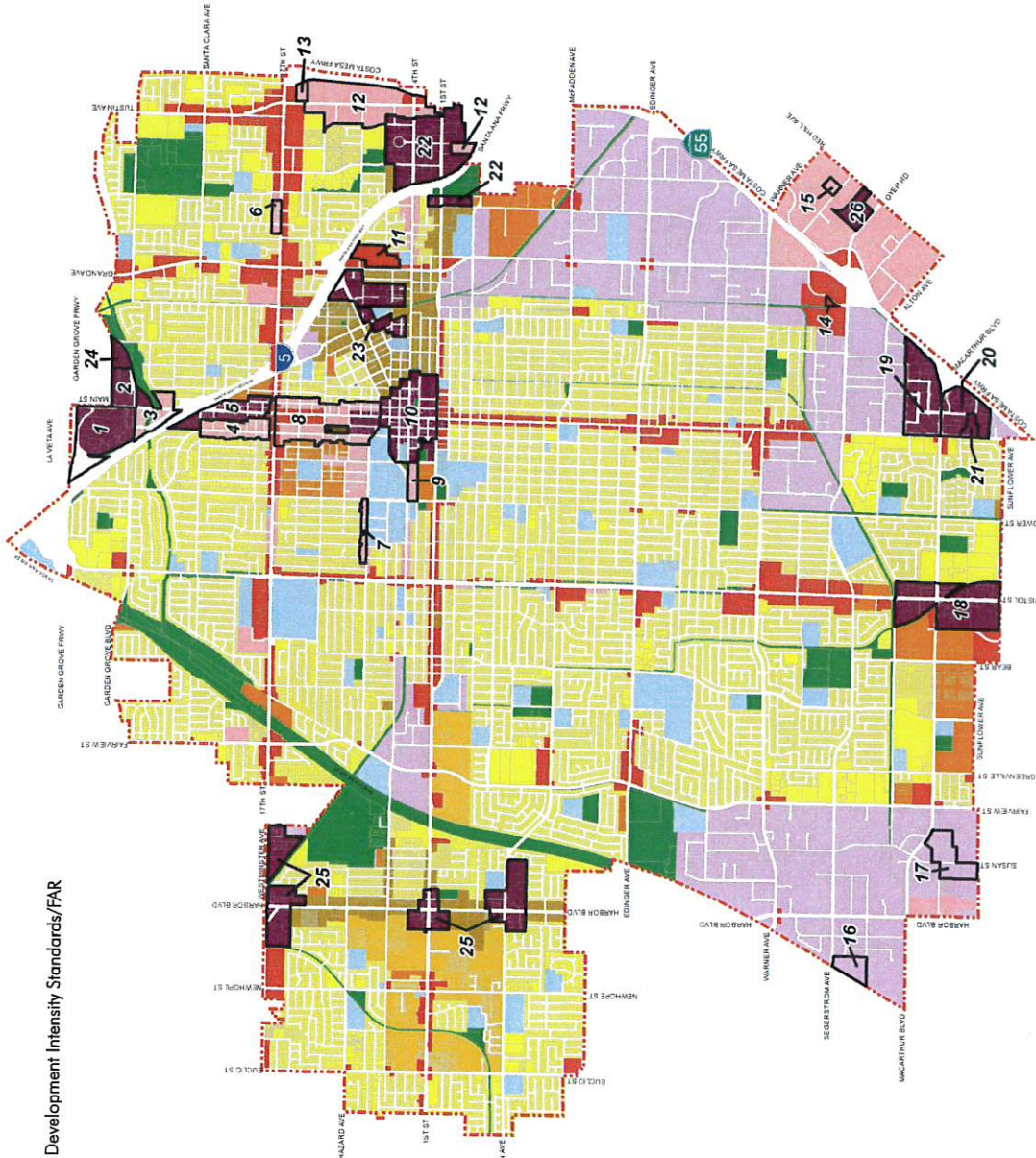
MR-15 (Medium Density Residential)



### Land Use Plan & Development Intensity Standards/FAR Areas



Pending - November 2020  
Land Use Element



## Residential

The Land Use Plan provides for three distinct residential land use designations. Residential development is also permitted in three other designations: District Center, One Broadway Plaza District Center, and Urban Neighborhood. The Santa Ana Land Use Plan includes the following residential land use designations:

- The **Low Density Residential (LR-7)** designation applies to those areas of the City which are developed with lower density residential land uses. The allowable maximum development intensity is 7 units per acre. Development in this category is characterized primarily by single-family homes. This designation applies to a large proportion of the City (6,465.96,463.7 acres) representing 47 percent of the City's total land area.
- The **Low-Medium Density Residential (LMR-11)** designation applies to those sections of the City which are developed with residential uses at permitted densities of up to 11 units per acre. The land area included in this designation is approximately 414.4421.6 acres. The great majority of the land designated as Low-Medium Density Residential is located in the westerly portion of the City, north and south of First Street. Properties with this designation are typically characterized by mobile home parks, a mixture of duplexes and single family residences, or small lot subdivisions.
- The **Medium Density Residential (MR-15)** designation applies to those sections of the City which are developed with residential uses at densities of up to 15 units per acre. Development in this designation is characterized by duplexes, apartments, or a combination of both. A total of 375.6369.1 acres is designated as Medium Density Residential. The designation applies to areas located in the vicinity of downtown, areas north and south of MacArthur Boulevard, and in other areas where there are established multiple-family development projects.



Harbor Boulevard, and other major arterial roadways in the City. The intensity standard applicable to this designation is a floor area ratio of 0.5 - 1.0, though most General Commercial districts have a FAR of 0.5. A total of ~~858.1~~859.6 acres of land is included in this designation.

General Commercial districts are key components in the economic development of the City. They provide highly visible and accessible commercial development along the City's arterial transportation corridors. In addition, General Commercial land uses provide important neighborhood facilities and services, including shopping, recreation, cultural and entertainment activities, employment, and education. The districts also provide support facilities and services for industrial areas including office and retail, restaurants and various other services.

The General Commercial development standards are based upon the character and intensity of development, as well as the degree of access and market demand for these properties. The relationships to adjacent land uses, are also considered. Uses typically located in this district are:

- Business and professional offices;
- Retail and service establishments;
- Recreational, cultural, and entertainment uses; and
- Vocational schools.

General Commercial Districts have a floor area ratio of 0.5 with the exception of the Mid-town area which has an floor area ratio of up to 1.0.

### Mixed Use

The Land Use Plan provides for two distinct mixed use land use designations. These designations allow for both vertical and horizontal mixed use developments, with an emphasis on linkages to a range of transportation options:

- The **District Center (DC)** land use designation includes the major activity areas in the City. Seven areas of the City, totaling 685.4 acres, are designated as District Center. The intensity standard for the District Center designation ranges from a floor ratio of 1.0 to 5.0.

District Centers are designed to serve as anchors to the City's commercial corridors, and to accommodate major development activity. District Centers are to be developed with an urban character that includes a mixture of high-rise office, commercial, and residential uses which provide shopping, business, cultural, education, recreation, entertainment, and housing opportunities. Residential developments within some District Centers are allowed at a density of up to 90 units per acre when developed as an integral component of a master planned mixed use project. In Harbor Corridor, Metro East, Downtown, and Transit Village District Centers residential



- **Redevelopment Plans.** The City will apply redevelopment tools associated with the implementation of the adopted redevelopment plans, as appropriate. The City will encourage the further development of industrial, commercial, and residential projects in suitable locations to strengthen the City's tax and employment base.
- **Special Studies.** In certain instances, a special study may be required to address a particular issue. In these cases, a specific effort to identify staff resources needed to conduct the appropriate investigation and analysis will be identified.
- **Zoning Code Review.** The zoning code serves as a primary tool used by the City to regulate development. The City will develop a program to revise the Zoning Ordinance to ensure that development regulations and standards are consistent with community needs and high quality development. The City will initiate appropriate changes to the ordinance to ensure, where appropriate, conformity between the Land Use Element and Zoning Map.

## LAND USE PLAN BUILDOUT

As indicated previously, the City of Santa Ana has been almost completely developed for many years. As a result, any new development will necessarily consist of redevelopment and infill development on the remaining vacant and underutilized parcels. Many parcels with nonresidential land use designations will never be developed to the maximum intensity permitted under the General Plan.

Table A-4 indicates the development possible under the build-out of the Land Use Plan. The build-out for residential land uses considered two scenarios. Effective build-out for residential development is calculated by adding the 21,896 units possible in the areas designated as District Center and Urban Neighborhood to the existing 74,669 units presently found in the City per Census 2000. Theoretical build-out for residential development considered the development possible if all of the areas designated as residential were developed according to the permitted Land Use Plan intensities. Since the Land Use Element does not contemplate the elimination of existing housing in the City, the effective build-out figure represents a more realistic estimate of future residential development.

As indicated in Table A-4, three of the non-residential land use designations have a range in FAR intensities. For the non-residential land use designations, effective build-out considered the development possible under the lower range of FAR intensities while theoretical build-out considered the upper FAR range. Typically, parking and landscaping requirements will result in significantly less floor area for commercial and industrial developments than that which is permitted under the General Plan.

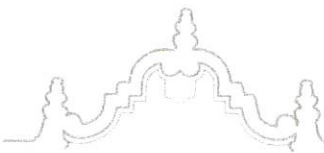
As indicated in Table A-4, between ~~77,350~~<sup>77,315</sup> to 96,565 housing units are allowed by the Land Use Plan. The additional units which presently exist in the City beyond the maximum number permitted under the theoretical buildout



## LAND USE ELEMENT

scenario are a reflection of the higher density multiple-family developments constructed in the 1970's and 1980's. However, the purpose of the Land Use Plan as it applies to the residential areas is to preserve and maintain the stability of existing neighborhoods, regardless of the character of development. The intent of the Plan is not to create any displacement, nor decrease existing development densities. Rather, it is to ensure a safe, healthy, and livable environment for City residents. Existing residential development entitlements are protected through this Land Use Element, applicable Zoning regulations, and sections of the City code pertaining to legal nonconforming uses.

The Land Use Element's implementation may result in an increase in the amount of commercial, office, and industrial development in the City. As indicated in Table A-4, up to ~~31,774,605~~ ~~31,808,407~~ square feet of commercial and office, and 42,199,991 square feet of industrial development are possible under the effective capacity parameters of Land Use Plan.





**Table A-4  
Land Use Plan Build-out Capacities**

Land Use		Acres	Intensity/ Density	Effective Buildout <sup>1</sup>		Theoretical Buildout	
<b>Residential</b>							
Low Density Residential	LR-7	6,465.9 6,463.7	7 du/ac				45,261 46,246 du
Low Medium Density Residential	LMR-11	414.4 421.6	11 du/ac				4,559 4,638 du
Medium Density Residential	MR-15	375.6 369.1	15 du/ac				5,634 5,536 du
<b>Subtotal</b>		<b>7,255.9 7,254.4</b>			<b>96,565 du<sup>1</sup></b>		<b>55,454 55,419 du</b>
<b>Mixed Use</b>							
				Non Res.	Res.	Non-Res.	Res.
<b>District Center</b>							
Other <sup>2</sup>	DC	309.5	90 du /ac FAR 1.0-2.0	11,955,583 sf	3,017 du	23,764,534 sf	3,017 du
Heritage	DC	18.8	FAR 1.7	54,090 sf	1,221 du	54,090 sf	1,221 du
Downtown	DC	62.5	FAR 3.0	2,057,824 sf	1,661 du	2,057,824 sf	1,661 du
Metro East	DC	113.9	FAR 0.75- 3.0	2,464,776 sf	5,037 du	2,464,776 sf	5,037 du
Transit Village	DC	51.4	FAR 5.0	402,864 sf	2,761 du	402,864 sf	2,761 du
Harbor Corridor	DC	125.0	FAR 5.0	1,836,155 sf	2,029 du	1,836,155 sf	2,029 du
One Broadway Plaza District Ctr <sup>3</sup>	OBPDC	4.3	FAR 2.9	310,000 sf	415 du	310,000 sf	415 du
Urban Neighborhood	UN	317.0	FAR 0.5-3.0	1,656,955 sf	5,755 du	1,656,955 sf	5,755 du
<b>Subtotal</b>		<b>1,002.4</b>		<b>20,738,247 sf</b>	<b>21,896 du</b>	<b>32,547,198 sf</b>	<b>21,896 du</b>
<b>Commercial</b>							
Professional & Admin. Office	PAO	600.8	FAR 0.5-1.0	13,085,424 sf		26,170,848 sf	
General Commercial	GC	858.1 859.6	FAR 0.5-1.0	18,689,181 18,722,983 sf		37,378,362 37,445,967 sf	
<b>Subtotal</b>		<b>1,458.9 1,460.4</b>		<b>31,774,605 31,808,407 sf</b>		<b>63,549,210 63,616,815 sf</b>	
<b>Industrial</b>							
Industrial	IND	2,152.8	FAR 0.45	42,199,991 sf		42,199,991 sf	
<b>Other</b>							
Institutional	INS	800.6	FAR 0.2-0.5	6,974,740 sf		17,436,850 sf	
Open Space	OS	1,010.9	FAR 0.2	8,806,961 sf		8,806,961 sf	
<b>Subtotal</b>		<b>1,811.5</b>		<b>15,781,701 sf</b>		<b>26,243,811 sf</b>	

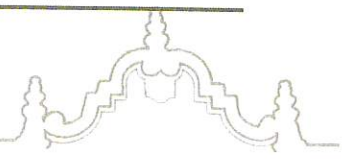
FAR=floor area ratio; d.u.=dwelling unit; s.f.=square feet (of floor area). Acreage shown in table does not include roads in right-of-way.

<sup>1</sup> Effective capacity for non-residential development assumes development possible under the lower range of FAR intensity standards with the exception of the Metro East District Center, Transit Village District Center, Downtown District Center, Heritage District Center, and Urban Neighborhood areas. The Harbor Corridor District Center, Metro East District Center, Transit Village District Center, Downtown District Center, and Urban Neighborhood areas allow a range of intensity for mixture of residential and non-residential development based on the zoning development standards. Residential effective capacity was calculated by adding the 21,896 units possible in the District Center and Urban Neighborhood with the existing 74,669 (Census 2000) housing units.

<sup>2</sup> Land use designation permits both residential and non-residential development. Build-out assumes 90% of land area will be developed as commercial and 10% will be developed as residential; with the exception of Town and Country Manor project intended for continuum of care and housing seniors.

<sup>3</sup> Land use designation permits high intensity office development with ancillary retail use.

This table has been revised to correspond with the GIS Land Use Map illustrated in Exhibit 2.



# **EXHIBIT 5**

## ORDINANCE NO. NS-XXXX

AN ORDINANCE OF THE CITY COUNCIL OF THE CITY OF SANTA ANA APPROVING AMENDMENT APPLICATION NO. 2020-02 REZONING THE PROPERTIES LOCATED AT 4310, 4314, 4318, 4322, 4326 AND 4330 WEST FIFTH STREET; 113, 117, 121, 201, 203, 207, 211, 221, 223, 225, 227, 229, 231, 233, 235, 237, 239, 241, 243, 245, 247, 301 AND 305 NORTH MOUNTAIN VIEW STREET; AND 4311 WEST FIRST STREET

THE CITY COUNCIL OF THE CITY OF SANTA ANA DOES ORDAIN AS FOLLOWS:

Section 1. The City Council of the City of Santa Ana hereby finds, determines and declares as follows:

- A. Steve Jones with Olympia Capital Corporation, representing Mountain View Real Estate Investments, LLC. ("Applicant") is requesting approval of Amendment Application (AA) No. 2020-02 to change the zoning designation of the properties located at 301 and 305 North Mountain View Street from General Agricultural (A1) to Two-Family Residence (R2) in order to facilitate construction of an 8-unit condominium development.
- B. In addition, the City of Santa Ana is proposing to change the land use designation of the properties located at 4310, 4314, 4318, 4322, 4326 and 4330 West Fifth Street, 4311 West First Street and 113, 117, 121, 201, 203, 207 and 211 North Mountain View Street from A1 to Single-Family Residence (R1); and 221, 223, 225, 227, 229, 231, 233, 235, 237, 239, 241, 243, 245 and 247 North Mountain View Street from Suburban Apartment (R4) to R2.
- C. On October 26, 2020, the Planning Commission held a duly noticed public hearing and voted to recommend that the City Council adopt an ordinance approving Amendment Application No. 2020-02 which is consistent with the General Plan land use designation of the subject properties.
- D. The City Council has reviewed applicable general plan policies and has determined that this proposed rezoning is consistent with the purpose of the general plan.
- E. The City Council, prior to taking action on this ordinance, held a duly noticed public hearing on November 17, 2020.
- F. The City Council also adopts as findings all facts presented in the Request for Council Action dated November 17, 2020, accompanying this matter.

- G. For these reasons, and each of them, Amendment Application No. 2020-02 is hereby found and determined to be consistent with the intent and purpose of Chapter 41 of the Santa Ana Municipal Code, thus changing the zoning district is found to be consistent with the General Plan of the City of Santa Ana and otherwise justified by the public necessity, convenience, and general welfare.

Section 2. The Amendment Application consists of amendments to the Zoning Map, as shown in Exhibit A, attached hereto and incorporated herein by reference.

Section 3. The City Council has reviewed and considered the information contained in the Mitigated Negative Declaration (Environmental Review No. 2018-83) prepared with respect to this project. The City Council has, as a result of its consideration of the record as a whole and the evidence presented at the hearings on this matter, determined that, as required pursuant to the California Environmental Quality Act (CEQA) and the State CEQA Guidelines, Environmental Review No. 2018-83 meets all the requirements of CEQA.

Section 4. An amended Sectional District Map, showing the above described changes in use district designation, is hereby approved and attached hereto as Exhibit A, and incorporated by this reference as though fully set forth herein.

Section 5. The City Council of the City of Santa Ana after conducting the public hearing hereby approves AA No. 2020-02. This decision is based upon the evidence submitted at the above said hearing, which includes, but is not limited to: the Request for Planning Commission Action dated October 26, 2020, the Request for Council Action dated November 17, 2020, and exhibits attached hereto; and the public testimony, written and oral, all of which are incorporated herein by this reference.

Section 6. The City Council approves AA No. 2020-02 as set forth in Exhibit A, attached hereto and incorporated herein by reference, subject to compliance with the Mitigation Monitoring and Reporting Program, and upon satisfaction of the conditions set forth below:

- A. Subject to compliance with the Mitigation Monitoring and Reporting Program, the Zoning Map shall be amended to read as set forth in Exhibit A, attached hereto and incorporated herein by reference.
- B. The Amendment Application shall not take effect unless and until Mitigated Negative Declaration (MND) and Mitigation Monitoring and Reporting Program (MMRP), Environmental Review No. 2018-83 and General Plan Amendment (GPA) No. 2020-04 are adopted by the City Council.

Section 7. The Applicant shall indemnify, protect, defend and hold the City and/or any of its officials, officers, employees, agents, departments, agencies, authorized volunteers, and instrumentalities thereof, harmless from any and all claims, demands, lawsuits, writs of mandamus, referendum, and other proceedings (whether legal, equitable, declaratory, administrative or adjudicatory in nature), and alternative

dispute resolution procedures (including, but not limited to arbitrations, mediations, and such other procedures), judgments, orders, and decisions (collectively "Actions"), brought against the City and/or any of its officials, officers, employees, agents, departments, agencies, and instrumentalities thereof, that challenge, attack, or seek to modify, set aside, void, or annul, any action of, or any permit or approval issued by the City and/or any of its officials, officers, employees, agents, departments, agencies, and instrumentalities thereof (including actions approved by the voters of the City) for or concerning the project, whether such Actions are brought under the Ralph M. Brown Act, California Environmental Quality Act, the Planning and Zoning Law, the Subdivision Map Act, Code of Civil Procedure sections 1085 or 1094.5, or any other federal, state or local constitution, statute, law, ordinance, charter, rule, regulation, or any decision of a court of competent jurisdiction. It is expressly agreed that the City shall have the right to approve, which approval will not be unreasonably withheld, the legal counsel providing the City's defense, and that Applicant shall reimburse the City for any costs and expenses directly and necessarily incurred by the City in the course of the defense. City shall promptly notify the Applicant of any Action brought and City shall cooperate with Applicant in the defense of the Action.

Section 8. This decision rendered by the City Council of the City of Santa Ana is final and is subject to judicial review pursuant to California Code of Civil Procedure section 1094.6. The Planning and Building Agency shall give direct notice to the Applicant of the City Council's decisions and these findings.

ADOPTED this \_\_\_\_ day of \_\_\_\_\_, 2020.

\_\_\_\_\_  
Miguel A. Pulido  
Mayor

APPROVED AS TO FORM:  
Sonia R. Carvalho  
City Attorney

By: \_\_\_\_\_  
Lisa Storck  
Assistant City Attorney

AYES: Councilmembers \_\_\_\_\_  
NOES: Councilmembers \_\_\_\_\_  
ABSTAIN: Councilmembers \_\_\_\_\_  
NOT PRESENT: Councilmembers \_\_\_\_\_

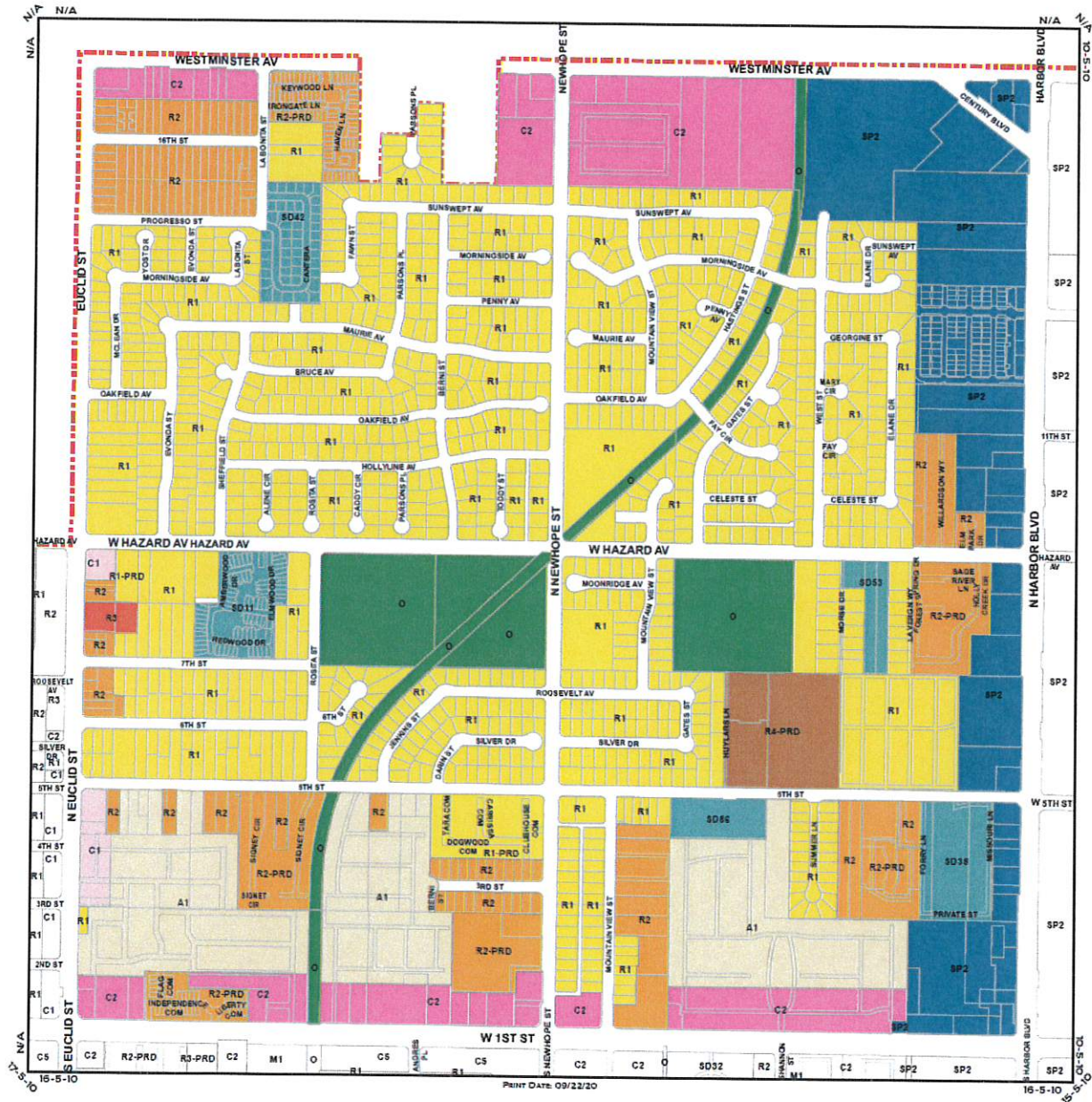
CERTIFICATE OF ATTESTATION AND ORIGINALITY

I, DAISY GOMEZ, Clerk of the Council, do hereby attest to and certify the attached Ordinance No. NS-\_\_\_\_\_ to be the original ordinance adopted by the City Council of the City of Santa Ana on \_\_\_\_\_, 2020 and that said ordinance was published in accordance with the Charter of the City of Santa Ana.

Date: \_\_\_\_\_

\_\_\_\_\_  
Clerk of the Council  
City of Santa Ana

# EXHIBIT A



## ZONING DISTRICTS

A1	GENERAL AGRICULTURAL	CSM	SOUTH MAIN STREET COMMERCIAL DIST.	R2	TWO-FAMILY RESIDENCE	-B	PARKING MODIFICATION
C1	COMMUNITY COMMERCIAL	GC	GOVERNMENT CENTER	R3	MULTIPLE-FAMILY RESIDENCE	-OZ	OVERLAY ZONE
C1-MD	COMMUNITY COMMERCIAL - MUSEUM DIST.	M1	LIGHT INDUSTRIAL	R4	SUBURBAN APARTMENT	-PRD	PLANNED RESIDENTIAL DEVELOPMENT
C2	GENERAL COMMERCIAL	M2	HEAVY INDUSTRIAL	RE	RESIDENTIAL ESTATE	-HD2	HEIGHT DISTRICT II
C4	PLANNED SHOPPING CENTER	O	OPEN SPACE	SD	SPECIFIC DEVELOPMENT		
C5	ARTERIAL COMMERCIAL	P	PROFESSIONAL	SP	SPECIFIC PLAN		
CR	COMMERCIAL RESIDENTIAL	R1	SINGLE-FAMILY RESIDENCE	OZ1	METRO EAST OVERLAY ZONE		

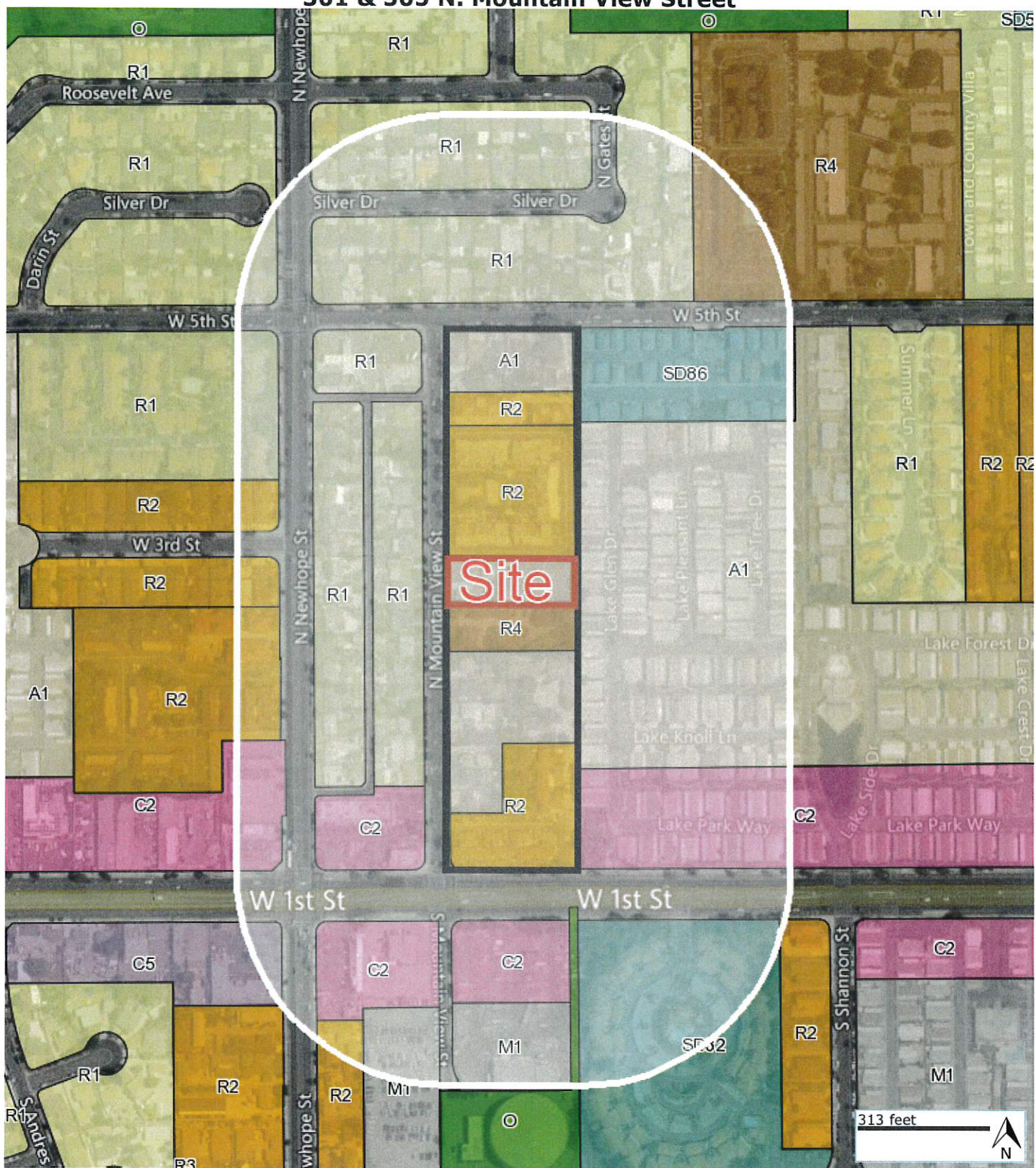
## SECTIONAL DISTRICT MAP: 9-5-10 CITY OF SANTA ANA, CALIFORNIA



# **EXHIBIT 6**



ER No. 2018-83, GPA No. 2020-04, AA No. 2020-02 & TTM No. 2019-02  
301 & 305 N. Mountain View Street



Vicinity Zoning & Aerial Map



# **EXHIBIT 7**

SITE PHOTO

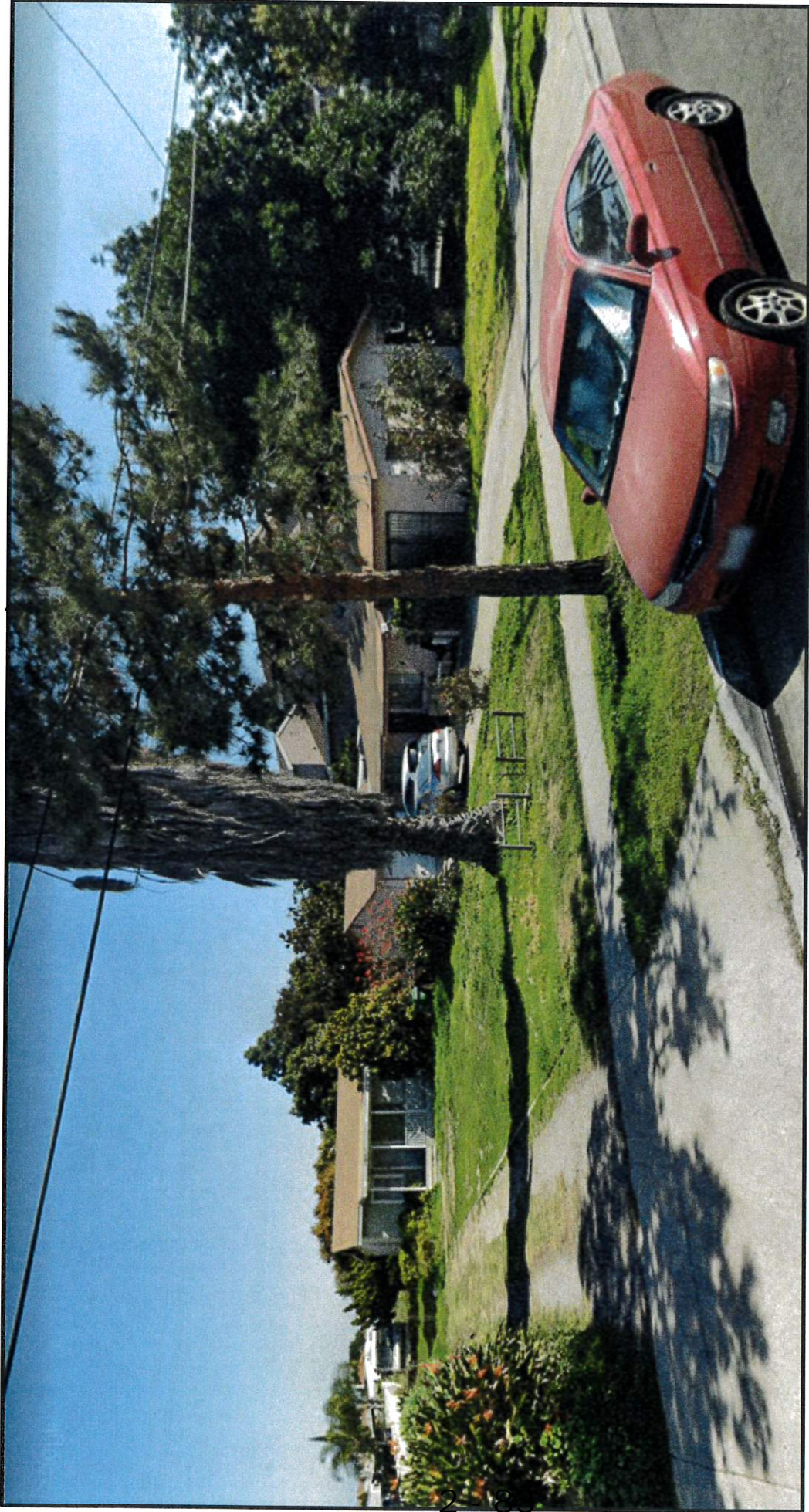


EXHIBIT 7



305 NORTH MOUNTAIN VIEW, SANTA ANA, CA 92703

PLANT SCHEDULE

TREES

- 1. Purple-leaf Alocasia
- 2. Aoyagi - Japanese maple
- 3. Fireglow - Japanese maple
- 4. Little Gem Magnolia
- 5. Red Japanese maple
- 6. Italian Cypress
- 7. Citrus
- 8. Palm-like plant
- 9. Palm tree

SHRUBS

- 1. Blue flowering shrub
- 2. Purple flowering shrub
- 3. Kalnia Angustifolia
- 4. Myrica Pensylvanica
- 5. Red flowering shrub

GROUND COVERS

- Common grass or Dymondia Margaretae
- Concrete

PROPOSED PLANT MATERIALS (PARTIAL LIST)

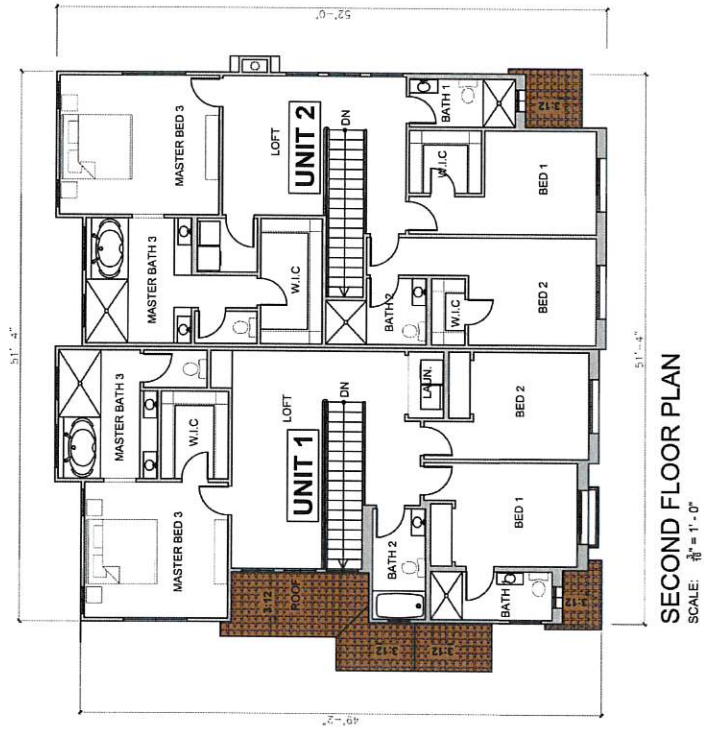
TREES



SHRUBS



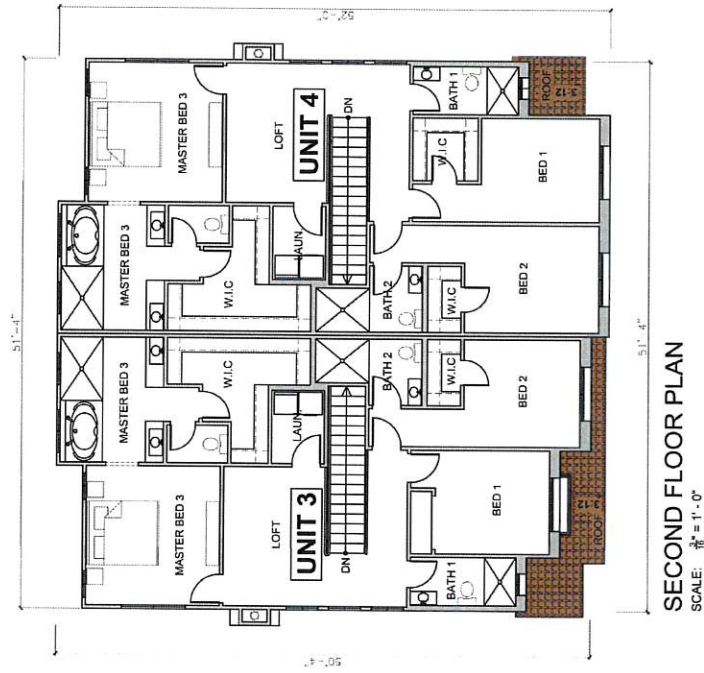
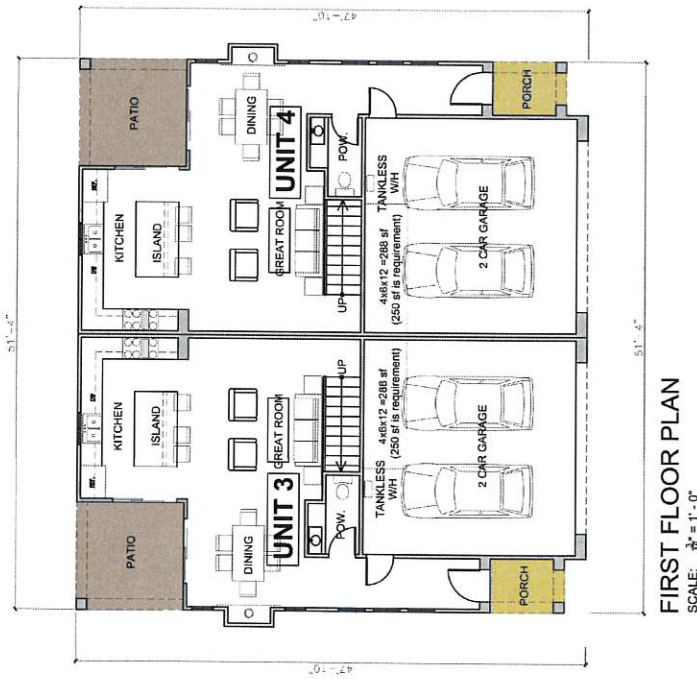
# **EXHIBIT 9**



TYPICAL UNIT 1-2

# 305 N. Mountain View Condos

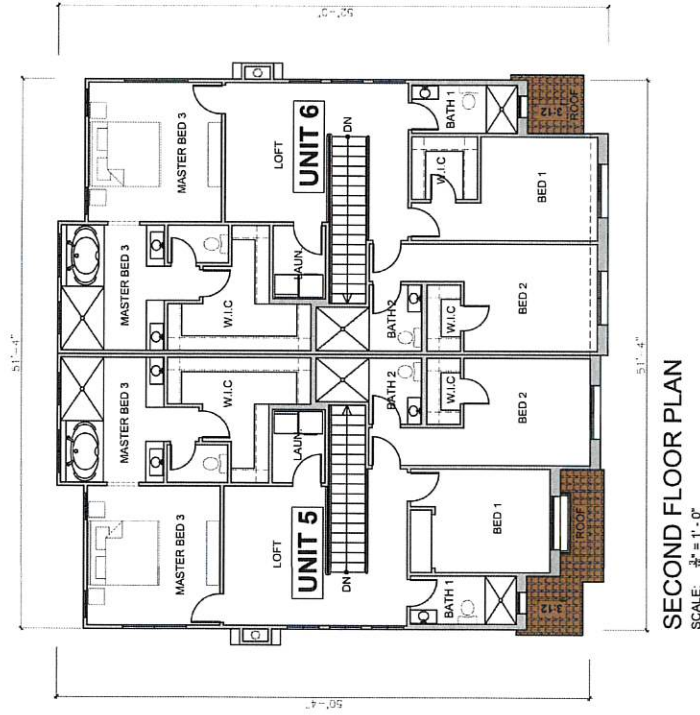
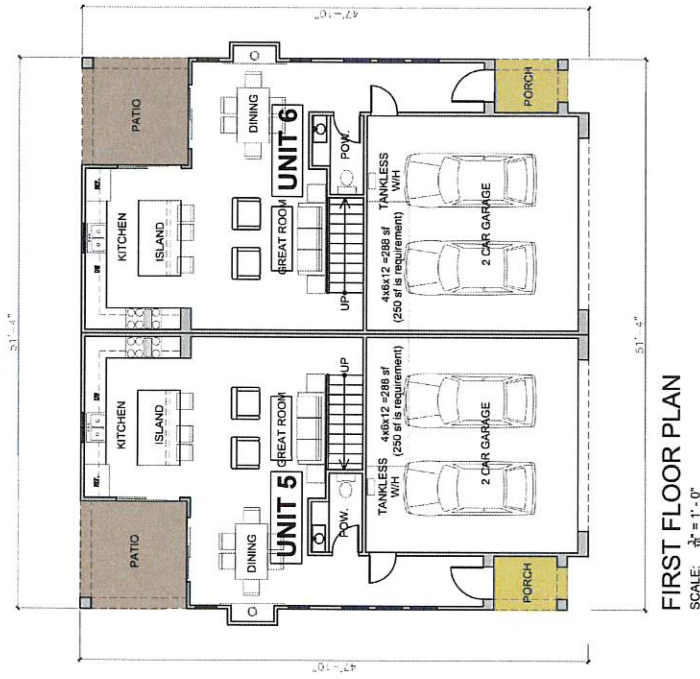
09.11.2020



TYPICAL UNIT 3-4

# 305 N. Mountain View Condos

09.11.2020

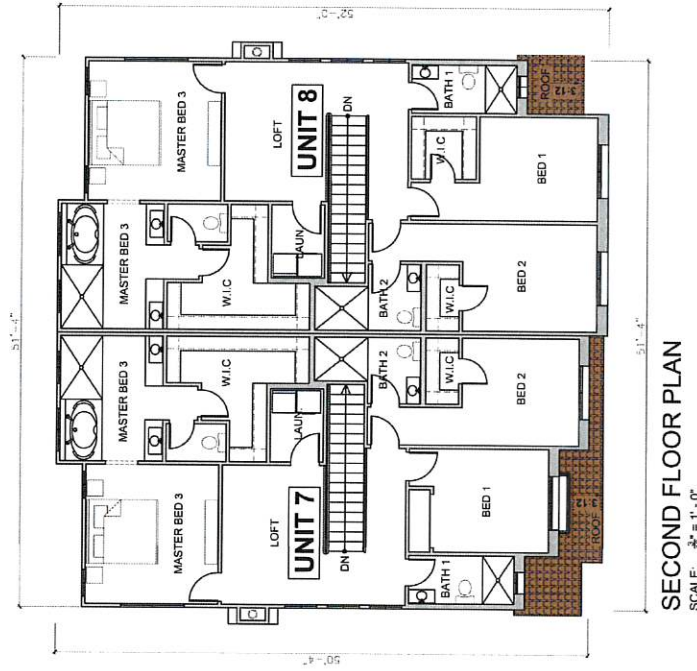
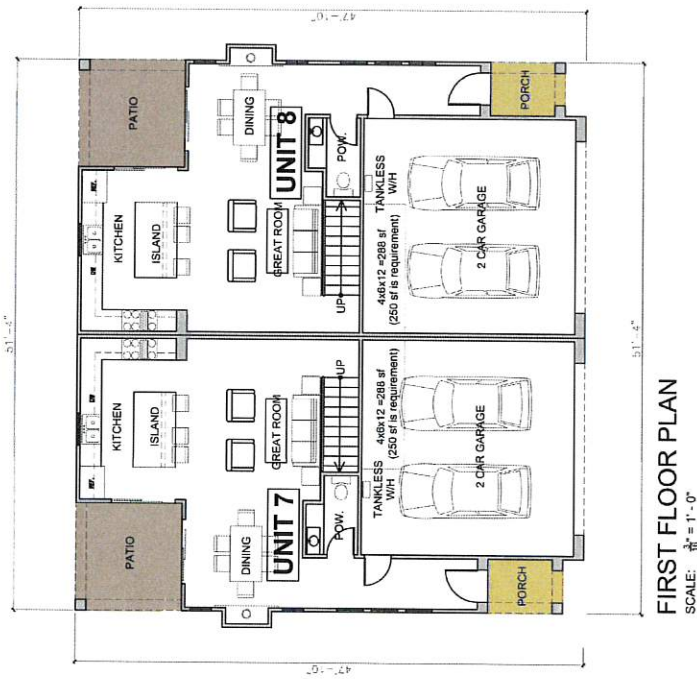


TYPICAL UNIT 5-6

# 305 N. Mountain View Condos

09.11.2020





TYPICAL UNIT 7-8

# 305 N. Mountain View Condos

09.11.2020

# **EXHIBIT 10**



Owner  
**R & E**

8821 Seaspray Drive. HB. CA 92646

## 305 N. Mountain View Condos

10.10.2020

Architect

**ANHA studio**

12862 Joy Street. GG. CA 92840



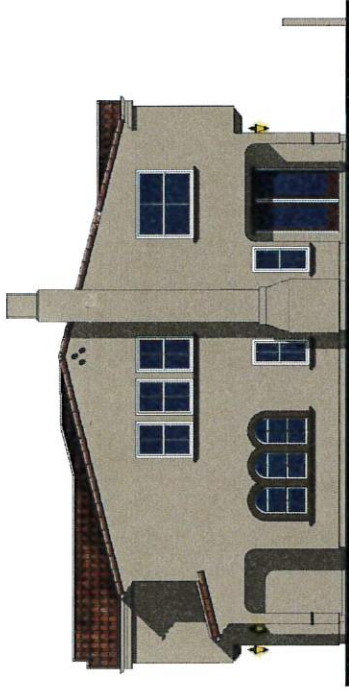
---

## 305 N. Mountain View Condos

10.10.2020



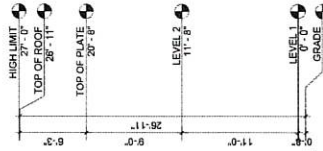
**FRONT ELEVATION**  
SCALE:  $\frac{1}{8}'' = 1'-0''$



**RIGHT ELEVATION**  
SCALE:  $\frac{1}{8}'' = 1'-0''$



**REAR ELEVATION**  
SCALE:  $\frac{1}{8}'' = 1'-0''$



COLOR SCHEME 4

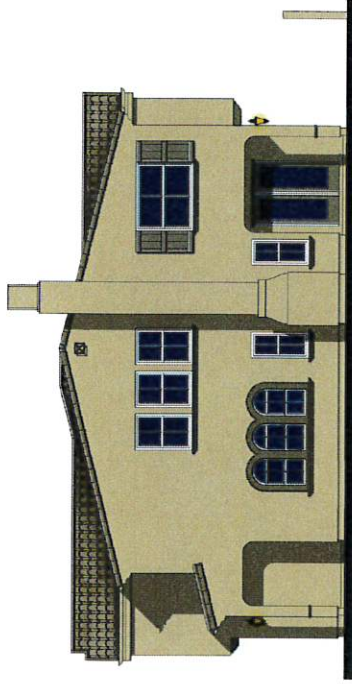
TYPICAL UNIT 1-2

# 305 N. Mountain View Condos

10.10.2020



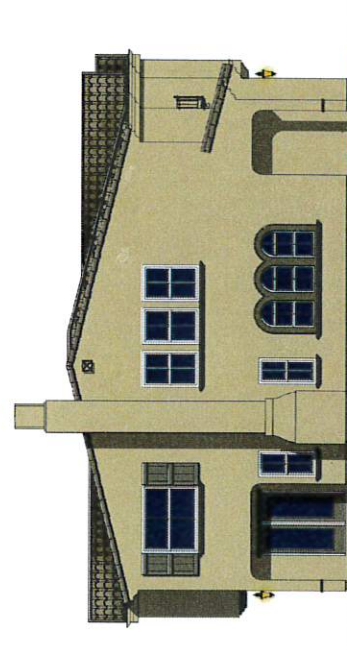
**FRONT ELEVATION**  
SCALE:  $\frac{1}{8}'' = 1'-0''$



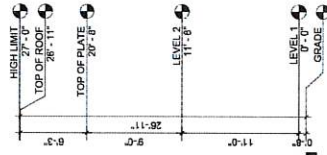
**RIGHT ELEVATION**  
SCALE:  $\frac{1}{8}'' = 1'-0''$



**REAR ELEVATION**  
SCALE:  $\frac{1}{8}'' = 1'-0''$



**LEFT ELEVATION**  
SCALE:  $\frac{1}{8}'' = 1'-0''$



COLOR SCHEME 2

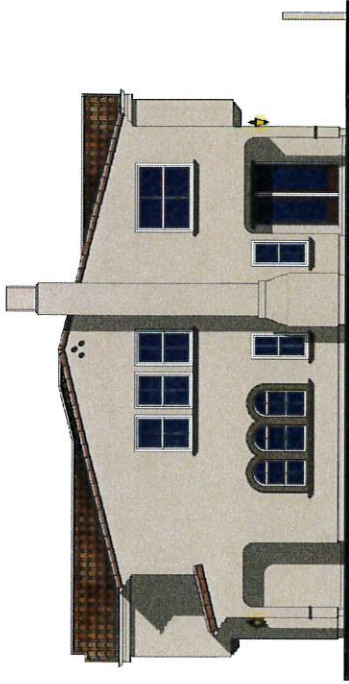
TYPICAL UNIT 3-4

# 305 N. Mountain View Condos

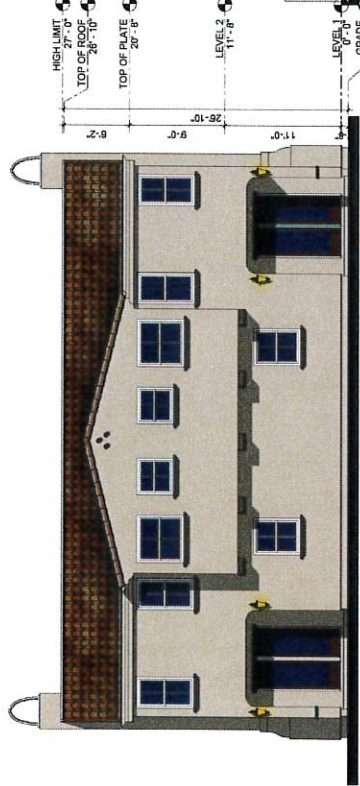
10.10.2020



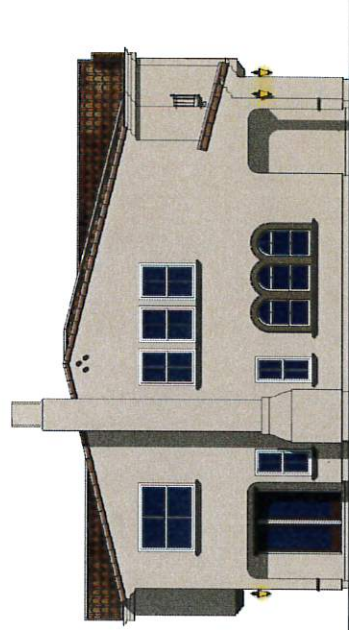
**FRONT ELEVATION**  
SCALE: 3/8" = 1'-0"



**RIGHT ELEVATION**  
SCALE: 3/8" = 1'-0"



**REAR ELEVATION**  
SCALE: 3/8" = 1'-0"



**LEFT ELEVATION**  
SCALE: 3/8" = 1'-0"

COLOR SCHEME 3

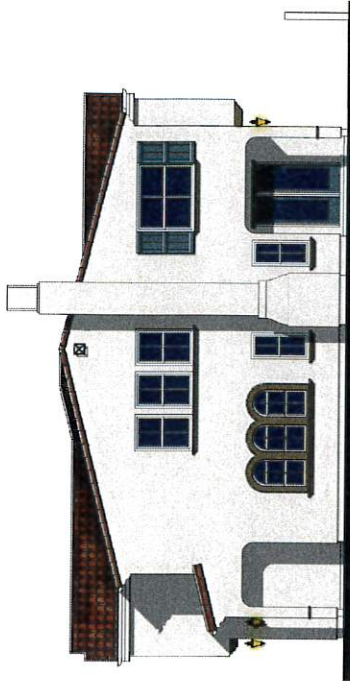
TYPICAL UNIT 5-6

# 305 N. Mountain View Condos

10.10.2020



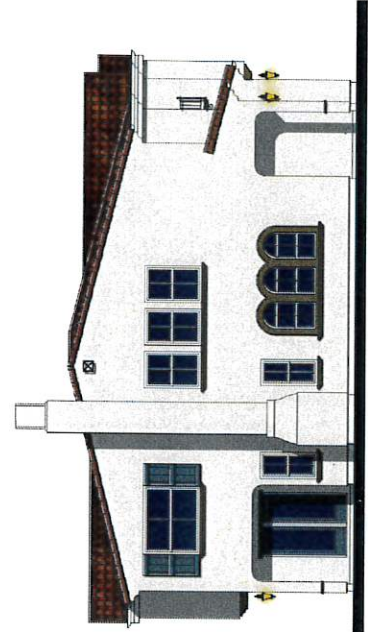
**FRONT ELEVATION**  
SCALE: 1/8" = 1'-0"



**RIGHT ELEVATION**  
SCALE: 1/8" = 1'-0"



**REAR ELEVATION**  
SCALE: 1/8" = 1'-0"



**LEFT ELEVATION**  
SCALE: 1/8" = 1'-0"

COLOR SCHEME 1

TYPICAL UNIT 7-8

# 305 N. Mountain View Condos

10.10.2020



# **EXHIBIT 11**



# **EXHIBIT 12**

**Mountain View Real Estate Investments**

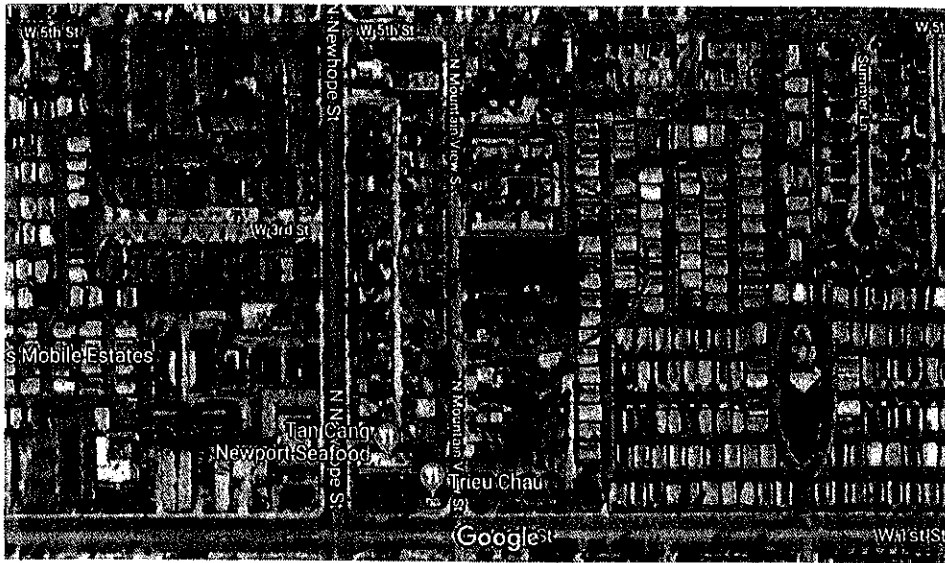
cordially Invites you to

**a Community Information Meeting**

to discuss a residential development proposal at  
305 N. Mountain View Street, Santa Ana, CA 92703

This project involves the construction of 8 new residential units with a modern design look to bring our community image to a better living community. Please come and share your thoughts and ideas about this project. At the meeting we will provide general information, answer questions, and solicit input on the project.

The site location of the proposed residential units is highlighted in blue.



**MEETING DATE AND TIME**

Tuesday, October 16<sup>th</sup>, 2018  
AT 5:00pm to 6:00pm

**MEETING LOCATION**

Salgado Community Center in Rosita Park  
706 N. Newhope St, Santa Ana, CA 92703

If you have questions regarding this event or you require language interpretation services in languages other than English, please contact Long Nguyen by phone at (714) 933 - 5686 or by email at Long-Realtor@Outlook.com

This notice is being provided pursuant to SAMC Section 2-153

**Mountain View Real Estate Investments**

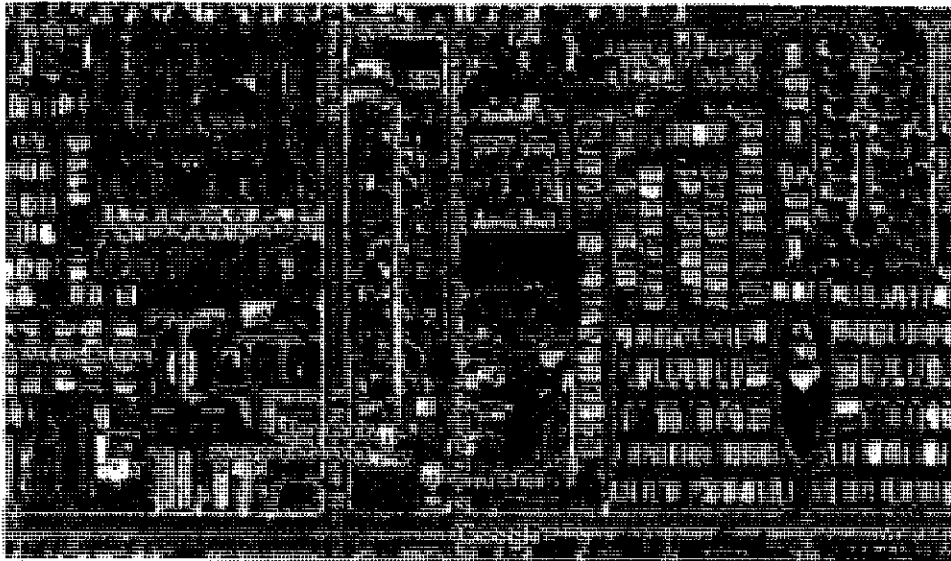
cordialmente te invita

**a una Reunion Comunitaria**

para discutir una propuesta de desarrollo residencial en  
305 N. Mountain View Street, Santa Ana, CA 92703

El proyecto involucra la construcción de 8 nuevas casas con un diseño moderno para traer a nuestra comunidad un área a una mejor comunidad de vida. Por favor venga a compartir tus pensamientos y ideas sobre este proyecto. En la reunión proveeremos información general, responder preguntas y solicitaremos información sobre el proyecto.

La ubicación del sitio de las unidades residenciales propuestas se resalta en azul.



**FECHA Y HORA DE REUNION**

Martes, October 16<sup>th</sup>, 2018  
AT 5:00pm to 6:00pm

**UBICACION DE LA REUNION**

Salgado Community Center in Rosita Park  
706 N. Newhope St, Santa Ana, CA 92703

Si tiene preguntas sobre esta reunión o si necesita servicios de interpretación en otro idioma, comuníquese con Long Nguyen por teléfono al (714) 933 - 5686 o por correo electrónico a [Long-Realtor@Outlook.com](mailto:Long-Realtor@Outlook.com)

Este aviso se envía en acuerdo con SAMC Sección 2-153

**Sunshine Ordinance Community Meeting Minutes**  
**For Proposed 8-Unit Condominium Development**  
**At 301 and 305 North Mountain View Street**  
**Held on October 16<sup>th</sup>, 2018 at 5:00pm to 6:00pm**

---

1. Six (6) neighbors were in attendance
2. Comments were made about traffic flow and the need to provide sufficient parking on site.
3. Open space for children to play was mentioned.
4. Some expressed the need to scale massing of the development to align with existing neighbors and to make sure the privacy of the adjacent residents was protected as much as possible.
5. There was a comment about properly locating the trash enclosures that serve the development.

Advertising Payment Receipt



digitalfirst  
M E D I A

*Los Angeles Daily News*  
*San Gabriel Valley Tribune • Pasadena Star-News • Whittier Daily News • Highlander*  
*The Sun • Daily Bulletin • Redlands Daily Facts*  
*Daily Breeze • Long Beach Press-Telegram • The Beach Reporter • Palos Verdes Peninsula News*  
*Gazette Newspapers*  
  
*Orange County Register • The Press-Enterprise*  
*Coast • OC Family • Excelsior*

Account Number: 5249614

Customer: **ADVANCED ESTATE REALTY**  
14615 MAGNOLIA ST.  
WESTMINSTER, CA 92683

Phone: 714-892-0407

Transaction Date: 10/4/2018

Transaction Type: Payment

Payment Amount: 216.00

Payment Method: Credit Card

Credit Card Number: XXXXXXXXXXXX9564

Expiration Date: 2/28/2022

Reference Number: 061373

Charge to: OCRP

Order Number: 0011183801

Credit to Transaction Number: P638439

Invoice Tax:

Invoice Notes:

Please note: If you pay by bank card, your card statement will show "SoCal Newspaper Group".

Date printed: Thursday, October 4, 2018

1907170

C:\Program Files\NEWS\CYCLE 9\Print\m\Adv\oc\Bov\oc\Authe\oc\Adv\Source\270\oc\95071-1214-0745624\c\adv\ 52496 Payment Receipt.pdf 11/19/2018 10:17



**City of Santa Ana, CA**

Parks, Recreation, and Community Services Agency  
20 Civic Center Plaza, P.O. Box 1988  
Santa Ana, CA 92702

714-647-5307  
CivicRecSA@santa-ana.org  
http://www.santa-ana.org

**Registration/Payment Receipt 11671433**

10/17/2018 11:23 AM

**Account Information**

Mountainview Real Estate Investment  
LLC.  
Long Nguyen  
8821 Seaspray Drive  
Huntington Beach, CA 92646

**Payment**

Check \$104.96  
(#1005)

**Received By**

Lilda Hernandez at Salgado Center  
Complex

Item	Quantity	Amount Paid
(01113002-57361) Salgado Center Complex Meeting Room A (Multi-Purpose Room) Oct 16, 2018 5:00 PM-6:00 PM - Group 3: \$80.78/Hour - PERMIT #3828	1.00	\$80.78
(01113002-53319) (1/2 Hr) Staff Fees	2.00	\$24.18
<b>Subtotal</b>		<b>\$104.96</b>
<b>Total Payment</b>		<b>\$104.96</b>

**Waiver(s)**

**Facility Waiver**

Parks, Recreation and Community Services Agency, 20 Civic Center Plaza, 2nd Floor, P.O. Box 1988, Santa Ana, CA 92702 – M-23 hereby grants \_\_\_\_\_ (hereinafter called the "Licensee" represented by \_\_\_\_\_, permission to use the Facilities as outlined, subject to Terms and Conditions of this Agreement contain herein and attached here to all of which form part of this Agreement.

It is the Permittee's responsibility to provide a copy of the this permit to each facility user or coach that uses the facility. The facility user or coach must present this permit to City representatives when requested to do so to identify themselves as the authorized user of the facility.

Permittee agrees to and shall indemnify and hold harmless the City, its officers, agents, employees, consultants, special counsel, and representatives from liability: (1) for personal injury, damages, or restitution, arising out of claims for personal injury, including death, and claims for property damage, which may arise from the negligence or willful misconduct of the permittee and guest or its agents, employees, or other persons acting on their behalf which relates to the Permit granted herein; and (2) from any claim that personal injury, damages, or restitution, is due by reason of the terms of or effects arising from this Permit. This indemnity and hold harmless agreement applies to all claims for damages, or restitution suffered, or alleged to have been suffered, by reason of the events referred to in this Section